

PORSCHE

**SPRINT CHALLENGE
GREAT BRITAIN**

PORSCHE SPRINT CHALLENGE GREAT BRITAIN 2024

REGULATIONS

PUBLISHED COPY – 13 May 2024

INTRODUCTION

These Regulations set out the key information relating to the motor racing championship called the "Porsche Sprint Challenge Great Britain" to be staged in 2024.

These Regulations are set out as follows:

| <u>Contents</u> | <u>Page number</u> |
|--------------------------|---------------------------|
| MISSION STATEMENT | 3 |
| CODE OF CONDUCT | 4 |
| CHAMPIONSHIP REGULATIONS | 5 |

MISSION STATEMENT

The objective of running the Porsche Sprint Challenge Great Britain 2024, for Porsche Cars Great Britain Limited, is to demonstrate and promote motorsport as an integral part of the Porsche brand at a local level. Through the Porsche Sprint Challenge, Porsche aims to demonstrate the Porsche ‘Race to Road’ engineering philosophy encapsulated within the 718 Cayman GT4 RS Clubsport and the 718 Cayman GT4 Clubsport and shared across the Porsche product range, and at the same time engage Porsche customers and fans in this philosophy, whether at the circuit, digitally, through television coverage and within the wider media, directly and indirectly.

The Championship will provide a one-make racing platform, which nurtures and develops driver talent. The organisation of the Championship puts the emphasis on driver development and looks to play an important role in the career path for career minded drivers by providing a platform to develop the racing and commercial skills required to progress, for example, into the Porsche Carrera Cup Great Britain, other motor racing formats or to become a Porsche works driver.

For the participating teams, the Championship seeks to be a commercially viable series, with tightly controlled technical regulations to support affordable but competitive racing and to allow teams to promote their engineering and technical expertise and any wider commercial interests that they may have.

For the numerous sponsors involved within the Championship, (both the partners of the Championship and the partners of participating drivers and teams), the Championship must provide a positive and engaging platform for their brands.

All of those involved in the Championship, including drivers and teams, are expected to uphold Porsche’s values of being sporting and always fair.

And, of course, Porsche hopes that all drivers, teams and fans enjoy the Championship.

.....
Ian Fletcher
Assistant Motorsport Manager and Championship Coordinator

Date: _____]

| |
|------------------------|
| CODE OF CONDUCT |
|------------------------|

The Porsche Sprint Challenge Great Britain 2024 is a racing series characterised by equality of opportunity and fairness – in both technical and sporting terms. Everyone involved in the Championship makes a significant contribution to how the Championship is perceived – both internally and by the general public – and to the atmosphere in the Championship through their conduct and their communication.

All those involved in the Championship are responsible for conducting themselves in such a way as to uphold and safeguard the professionalism that prevails in the Championship, as well as the esteem in which the Championship and its participants are held by the general public. Moreover, fair and sporting competition is an important contributor to exciting and safer racing.

For these reasons, all those involved in the Championship agree to acknowledge the philosophy of the Championship, to comply with the spirit of this code of conduct and to adhere strictly to these Regulations.

Both on the race track and in all matters related to the Championship, all those involved in the Championship must adopt and adhere to the spirit and intent of the following principles:

- To act in good faith and treat other participants, officials and organisers respectfully;
- To act with the utmost integrity at all times;
- To respect and follow the laws and the rules of the sport, and by their behaviour exemplify and promote fairness and the rules of conduct;
- To neither express themselves or behave in an insulting, offensive or abusive way, nor tolerate such expressions or modes of conduct, either in direct conversations, interviews, etc. or in other communication, e.g. press releases, posts in social media, etc;
- Motor racing can be dangerous: it is of paramount importance and incumbent upon all those involved in the Championship to always behave in the interests of safety and to continually and consistently cooperate in all efforts to reduce risks;
- To use resources in a sustainable way, giving priority to the well-being, safety and satisfaction of others before their own personal interest or goals;
- To always further the purpose of the sport;
- To challenge others where their conduct is not characterised by fairness, sportsmanship, respect and tolerance; and
- To cooperate with all other persons involved so as to continually further develop and improve the Championship and its good status.

CONTENTS

| | | |
|------|--|----|
| 1 | SPORTING REGULATIONS | 8 |
| 1.1 | Glossary | 8 |
| 1.2 | Title and jurisdiction | 8 |
| 1.3 | Officials | 8 |
| 1.4 | Registration | 9 |
| 1.5 | Online Tests | 11 |
| 1.6 | Medical | 11 |
| 1.7 | Category selection | 11 |
| 1.8 | Category protests and reviews | 12 |
| 1.9 | Licence and BARC membership | 13 |
| 1.10 | Car | 14 |
| 1.11 | Early registration | 14 |
| 1.12 | Rounds | 14 |
| 1.13 | Scoring | 14 |
| 1.14 | Prizes awarded at the end of the Championship | 17 |
| 1.15 | Presentations | 18 |
| 1.16 | Withholding tax for foreign performers and income tax | 19 |
| 1.17 | Championship livery | 19 |
| 1.18 | Timetable regulations | 19 |
| 1.19 | Postponement, abandonment or cancellation of a Meeting | 20 |
| 1.20 | Shareholding | 20 |
| 2 | JUDICIAL PROCEDURES | 22 |
| 2.1 | Protests, appeals and investigatory powers | 22 |
| 2.2 | Governing law and jurisdiction | 22 |
| 3 | RACE PROCEDURES | 23 |
| 3.1 | Entries into a Round | 23 |
| 3.2 | Signing-on and briefings | 23 |
| 3.3 | Testing | 23 |
| 3.4 | Qualifying | 24 |
| 3.5 | Rounds | 25 |
| 3.6 | Starting grid | 25 |
| 3.7 | Formation Lap | 26 |
| 3.8 | Standing start procedure | 27 |
| 3.9 | Rolling start procedure | 28 |
| 3.10 | Safety Car | 28 |
| 3.11 | Stopping a Qualifying Session | 29 |
| 3.12 | Stopping a Round | 29 |
| 3.13 | Re-scrutiny and Driver availability | 30 |
| 3.14 | Paddock, Pits and Pit Lane safety | 30 |
| 3.15 | Finishes to Qualifying Sessions and Rounds | 31 |
| 3.16 | Results | 32 |

EXECUTION VERSION

| | | |
|------|---|----|
| 3.17 | General regulations | 32 |
| 3.18 | Timing modules | 33 |
| 3.19 | Adverse weather conditions..... | 33 |
| 3.20 | Alcohol breathalyser test | 33 |
| 3.21 | Tail lifts | 34 |
| 4 | PENALTIES | 35 |
| 4.1 | Infringement of Technical Regulations..... | 35 |
| 4.2 | Infringements of non-Technical Regulations..... | 36 |
| 5 | TECHNICAL REGULATIONS | 38 |
| | PART A – PORSCHE 718 CAYMAN GT4 CLUBSPORT | 39 |
| 5.1 | Introduction..... | 39 |
| 5.2 | Safety requirements | 39 |
| 5.3 | Permitted modifications and built-in components | 40 |
| 5.4 | Weight | 41 |
| 5.5 | Ground clearance | 42 |
| 5.6 | Brakes | 42 |
| 5.7 | Steering and suspension..... | 43 |
| 5.8 | Shock absorbers | 44 |
| 5.9 | Engine | 44 |
| 5.10 | Gearbox | 44 |
| 5.11 | Lubricant and coolant..... | 45 |
| 5.12 | Wheels..... | 45 |
| 5.13 | Tyres | 45 |
| 5.14 | Tyre allocation | 46 |
| 5.15 | Declaration of tyres | 47 |
| 5.16 | Replacement of damaged tyres | 47 |
| 5.17 | Control of Fuel..... | 47 |
| 5.18 | Noise test..... | 48 |
| 5.19 | Radio..... | 48 |
| 5.20 | ECU | 48 |
| 5.21 | Data | 48 |
| 5.22 | Cameras..... | 49 |
| 5.23 | Bodywork..... | 50 |
| 5.24 | Windscreen, windows and ventilation | 50 |
| 5.25 | Rear wing..... | 50 |
| 5.26 | Additional requirements | 50 |
| 5.27 | Virtual Flag System | 51 |
| 5.28 | Safety Self-Declaration Form..... | 51 |
| 5.29 | Seal | 51 |
| | PART B – PORSCHE 718 CAYMAN GT4 RS CLUBSPORT | 53 |
| 6 | COMMERCIAL REGULATIONS | 68 |
| 6.1 | Introduction..... | 68 |
| 6.2 | Commercial Rights..... | 68 |
| 6.3 | Commercial Partners..... | 68 |

EXECUTION VERSION

| | | |
|---|---|-----|
| 6.4 | Specific regulations relating to broadcasting | 69 |
| 6.5 | Use of Championship Marks..... | 69 |
| 6.6 | Use of Entrant Logo and Driver imagery | 69 |
| 6.7 | Stickers and flags | 71 |
| 6.8 | Reserved Rights | 71 |
| 6.9 | "Behind the scenes" filming | 72 |
| 6.10 | Video Data Logger footage..... | 72 |
| 6.11 | Use of Broadcast Footage..... | 73 |
| 6.12 | How to obtain Broadcast Footage..... | 73 |
| 6.13 | Penalties | 73 |
| 6.14 | Passes | 74 |
| 6.15 | Paddock regulations | 75 |
| 6.16 | Confidentiality | 77 |
| 6.17 | Early registration | 77 |
| APPENDIX 1: CHAMPIONSHIP LIVERY POSITIONS | | 79 |
| APPENDIX 2: CHAMPIONSHIP REGISTRATION FORM | | 80 |
| APPENDIX 3: STAFF AND VEHICLE INFORMATION FORM | | 93 |
| APPENDIX 4: POSITION OF THE DRIVER BADGES | | 94 |
| APPENDIX 5: VEHICLE DESCRIPTION | | 95 |
| APPENDIX 6: CHAMPIONSHIP LOGO | | 99 |
| APPENDIX 7: INDEMNITY FORM FOR DRIVER COACHES | | 100 |
| APPENDIX 8: SOCIAL MEDIA POLICY | | 102 |
| APPENDIX 9: CONTACT SHEET | | 104 |
| APPENDIX 10: RACING WITH RESPECT | | 106 |
| APPENDIX 11: SAFETY SELF-DECLARATION FORM | | 107 |
| APPENDIX 12: PORSCHE SPRINT CHALLENGE 2024 MEDICAL FORM | | 109 |
| APPENDIX 13: TESTING FORM | | 113 |
| APPENDIX 14 GLOSSARY OF TERMS | | 114 |

| | |
|----------|-----------------------------|
| 1 | SPORTING REGULATIONS |
|----------|-----------------------------|

1.1 Glossary

1.1.1 The glossary in Appendix 14 applies to these Regulations.

1.2 Title and jurisdiction

1.2.1 The Championship Permit is granted by the ASN to and held by BARC. The Events are organised by BARC and the Championship is promoted and administered by Porsche. The Championship is organised pursuant to the General Regulations of Motorsport UK (incorporating the provisions of the International Sporting Code of the FIA) (the "**Motorsport UK Regulations**") and these Championship Regulations.

Motorsport UK Championship Permit Number: CH2024/R008 (B)

Race Status: 718 Cayman GT4 Clubsport Race Club

718 Cayman GT4 RS Clubsport Race National

Motorsport UK Championship Grade: B

1.2.2 For the purposes of these Championship Regulations:

(A) references to BARC (or Organising Club) shall be construed as meaning BARC and/or Porsche; and

(B) references to Porsche shall be construed as Porsche and/or BARC.

However, for the avoidance of doubt BARC, shall be accountable to the ASN as the Championship Permit Holder.

1.2.3 The Championship shall be governed by and conducted in accordance with these Regulations and the Motorsport UK Regulations and each Driver and each Entrant shall comply in full with the foregoing and with all applicable law in relation to their/its participation in the Championship. In the event of any conflict between the Motorsport UK Regulations and these Regulations then the Motorsport UK Regulations shall prevail.

1.2.4 Subject to Motorsport UK Regulation D11, Porsche has the right to amend or vary these Regulations at any time before or during the Season and to issue additional statements in the form of a Bulletin. All Entrants and Drivers agree to be bound by the Regulations (including any amendments, variations and statements from time to time) and to procure compliance by persons associated with them.

1.2.5 Any request by a Driver or Entrant (or potential Driver or Entrant) for clarification of the Regulations should be made in writing to the Championship Coordinator. The request together with the reply will be made known to every other Entrant. Any verbal requests for clarification and any verbal replies will not be binding and will not therefore be made available to each Entrant.

1.3 Officials

1.3.1 The following individuals shall fulfil the following roles:

Championship Coordinator: Ian Fletcher (Porsche)

Clerk of the Course Nigel Jones (BARC)

Deputy Clerk of the Course: Colin Oakley (BARC)

Eligibility Scrutineer: Simon Holloway (BARC)

Championship Stewards (any three of): Ian Watson (BARC)

Pat Blakeney (BARC)

Ray Sumner (BARC)

Alan Gow (BARC)

James MacNaughton (Porsche)

Eddie Corr (Porsche)

Event Planner: Annabel Edmed (Porsche)

Medical Adviser: Dr Paul Trafford

1.3.2 Judges of Fact for each Meeting will be appointed in accordance with Motorsport UK Regulation G10.

1.3.3 The Officials shall have the rights, powers and duties specified in the Motorsport UK Regulations. In particular, any three of the Championship Stewards may sit to make a decision. In accordance with Motorsport UK Regulation G2.7, the Championship Stewards may only adjudicate on any disputes, irregularities or appeals arising from these Regulations. Under Motorsport UK Regulation G2.7.1, the Championship Stewards are also empowered to consider any request from the Championship Co-ordinator to penalise any Driver or Entrant for any breach of these Regulations after holding a formal hearing to impose a penalty in accordance with Motorsport UK Regulation C2.1.1 (subject to the rights of appeal provided for in Motorsport UK Regulation C).

1.3.4 The Organising Club may appoint additional Officials and/or change the identity of the Officials from time to time and either Porsche or the Organising Club shall notify each Entrant accordingly.

1.3.5 The contact details for certain Officials listed in Section 1.3.1 are set out in the Contact Sheet.

1.4 Registration

1.4.1 Any individual wishing to register as a Driver for the Championship must complete the Registration Form (including the details in relation to that Driver's Entrant and the signature of that Entrant Manager) and the Medical Form. The Registration Form must be submitted to the Championship Coordinator and the Medical Form must be submitted to the Medical Adviser, in each case, between 1 November 2023 and 13 May 2024 (inclusive). Each Driver warrants that the information provided in their Registration Form and Medical Form is true, complete and accurate.

1.4.2 If any registration is submitted by a Driver after 13 May 2024 and such application for registration is accepted, that Driver shall pay (or arrange for such payment to be made on their behalf) the pro rata amount of the Registration Fee to reflect the number of Meetings left in the Championship at the point of Registration (eg, if three of the six Meetings remain, the pro rata Registration Fee shall be 50% of the full Registration Fee). No application for registration can be made such that the Driver only participates in the final Meeting.

1.4.3 Subject to Section 1.4.15, any Driver that registers for the Championship after the conclusion of the second Meeting shall not be eligible for Championship Points and/or Category Points and that Driver's Entrant shall not be eligible for Entrant Points based on that Driver's performance, save that if such Driver is a Substitute Driver and the substituted Driver's Entrant would have been eligible for Entrant Points based on the substituted Driver's performance, then in that circumstance the Entrant shall be eligible for Entrant Points based on the performance of the Substitute Driver.

1.4.4 The Registration Fee payable by (or on behalf of) a potential Driver to register for the Championship is as follows:

| Category | Registration Fee |
|--------------------------------------|------------------|
| Professional – Clubsport Category | £20,000 plus VAT |
| Professional – RS Clubsport Category | £20,000 plus VAT |
| Amateur - Clubsport Category | £20,000 plus VAT |
| Amateur – RS Clubsport Category | £20,000 plus VAT |

1.4.5 Any individual applying for registration as a Driver for the Championship must be at least 16 years of age by the Friday prior to the first Meeting in which they compete.

EXECUTION VERSION

- 1.4.6 The Registration Fee is payable against the chassis number of the Car listed on the Registration Form. In the event that the chassis of a Car is destroyed during the Championship, such registration may be transferred to the replacement Car, provided that the relevant Entrant Manager notifies the Championship Coordinator and the Championship Coordinator approves the replacement Car. In such circumstances, any Driver and Entrant shall be eligible for Championship Points, Category Points and Entrant Points.
- 1.4.7 The Registration Fee is required in full when submitting a Registration Form and, subject to Motorsport UK Regulation H30.1.2, is non-refundable.
- 1.4.8 Porsche shall, within seven days of receipt of each Registration Form, acknowledge receipt of such Registration Form and notify the relevant Driver whether the application has been accepted, rejected or the decision deferred.
- 1.4.9 Porsche reserves the right to refuse any application for registration. Porsche will notify the potential Driver in writing if that potential Driver's application is refused and Porsche will refund that Driver's Registration Fee (if paid).
- 1.4.10 If Porsche accepts a potential Driver's registration, Porsche will notify that potential Driver in writing and, on and from the date of such notification, that individual will become a "Driver" and issued with a Race Number. The Race Number will not be changed during the Championship. Each Driver must display their Race Number as set out in Motorsport UK Regulations J4 and Q11.
- 1.4.11 Save as set out in this Section 1.4.11 and save when a Driver wishes to participate in a Round but is not permitted to do so under Section 3.1.1, each Driver must participate in all Rounds.
- (A) Any Driver that cannot participate in a Round must notify the Championship Coordinator (with reasons) in writing no later than 48 hours before the Round in question. Any Driver that fails to notify the Championship Coordinator by this deadline will incur a fine of £1,000 unless the Championship Coordinator determines that exceptional circumstances apply.
- (B) If the Driver has notified the Championship Coordinator that they cannot participate in a Round in accordance with Section (A)1.4.11(A) above, their Car may be driven in that Round by a different Driver (the "**Substitute Driver**") with the prior written permission of the Championship Coordinator, provided that the Substitute Driver is either registered as a Driver for the Championship for the same Entrant or registers as a Driver in accordance with the terms of these Regulations for the same Entrant for the Championship prior to that Round.
- (C) The Substitute Driver is eligible to be awarded Points (as applicable for that Substitute Driver's relevant Category) and the Entrant to which the Car is registered is eligible to be awarded Entrant Points. For the avoidance of doubt, the Driver that does not participate in the Round and is replaced by the Substitute Driver will not be awarded any Points.
- 1.4.12 An Entrant may only replace a Car during the Championship if the relevant Entrant Manager notifies the Championship Coordinator and the Championship Coordinator has issued consent to the replacement. Unless Section 1.4.6 applies, any Driver and Entrant racing with a replacement Car in accordance with the foregoing shall only be eligible for Championship Points, Category Points and Entrant Points if the Entrant Managers of each other Entrant unanimously agree.
- 1.4.13 The Registration Fee includes the entry fee for each Round, Qualifying Session, Friday Free Practice and Porsche Test Day as well as three hospitality passes for each day of each Event and the Championship Launch Day. For the avoidance of doubt, it is the Driver's responsibility to obtain use of a Car to participate in the Championship and the Registration Fee does not include any costs in relation to the purchase or hire of such Car or any costs related to the running, repair or replacement of such Car. The Registration Fee does not cover the provision of generator power to private motorhomes, caravans or suchlike during an Event. Generator power can be provided for such use via TOCA's official power supplier, provided that sufficient Drivers book this at least seven days in advance of each Event to warrant a separate generator for such use being provided. Any Driver connecting to the TOCA official power supplier's generators without pre-booking or paying upon demand will be immediately disconnected and fined a minimum of £100.
- 1.4.14 Porsche may publicise a Driver's and/or Entrants' registration upon payment of the Registration Fee. An official list of the Drivers and Entrants for the Championship shall be circulated via a Bulletin no later than 48 hours prior to the first Meeting.
- 1.4.15 In the event that a Driver wishes to change from one Entrant to another Entrant during the course of the Season then they must submit a new Registration Form and re-submit to the process detailed in this Section 1.4 (or otherwise act in

EXECUTION VERSION

accordance with the instructions of Porsche in relation to such application). In the event that the Driver's new registration is approved by Porsche, exercising its discretion to accept such application based on all the circumstances of the case, the Category Points and Championship Points accrued by the Driver will remain with the Driver and any Entrant Points accrued by the Driver for their original Entrant will remain with their original Entrant. The Driver may accrue Entrant Points for their new Entrant from their first Round as a Driver of that Entrant.

1.4.16 Porsche reserves the right to cancel the Championship at any point. If Porsche cancels the Championship, it shall notify each Driver and each Entrant via a Bulletin and such Bulletin will set out the consequences of such cancellation.

1.5 Online Tests

1.5.1 Prior to each Driver and Entrant Manager participating in their first Meeting of the Championship, that Driver or Entrant Manager must complete and pass the Online Test.

1.5.2 Certain Drivers and Entrant Managers may, in addition to the testing in Section 1.5.1, be selected at random on one day of each Meeting and those Drivers and Entrant Managers must complete and pass the Online Test.

1.5.3 If any Driver or Entrant Manager fails a test required under Sections 1.5.1 or 1.5.2, that Driver may not participate in any Meeting until either:

- (A) that Driver or Entrant Manager has subsequently completed and passed the Online Test; or
- (B) the Clerk of the Course notifies that Driver or Entrant Manager that the Clerk of the Course is satisfied that such Driver or Entrant Manager understands the Regulations and the Motorsport UK Regulations to a standard satisfactory to the Clerk of the Course.

If a Driver is not permitted to compete in a Meeting (or part of a Meeting) due to failing an Online Test then Porsche shall provide a pro rata refund of the Registration Fee for that Meeting (or part of a Meeting) (eg, if the Driver is not permitted to compete in one Meeting, the pro rata refund shall be one sixth of the full Registration Fee).

1.6 Medical

1.6.1 Drivers must notify the Medical Adviser if:

- (A) they are involved in any serious medical incident;
- (B) there is a significant change in their physical or mental condition from the condition stated on their Medical Form;
- (C) they are hospitalised for any reason; or
- (D) they take drugs for any medical condition that was not noted on their Medical Form (or otherwise notified in writing to the Medical Adviser).

1.6.2 At any time during a Round the Clerk of the Course can require a Driver to have a medical examination by the Medical Adviser (or their nominee).

1.7 Category selection

1.7.1 The Championship will have four categories (each, a “**Category**”, and “**Categories**” shall be construed accordingly):

- (A) Professional – Clubsport Category;
- (B) Professional; - RS Clubsport Category;
- (C) Amateur – Clubsport Category; and
- (D) Amateur - RS Clubsport Category.

1.7.2 Any individual interested in participating in the Championship as a Driver shall indicate on their Registration Form the Category in which they believe they should participate.

EXECUTION VERSION

- 1.7.3 Porsche will review each individual's selected Category and decide whether to accept that selection. The criteria applied by Porsche in making this decision will include the Car that the Driver intends to drive, the potential Driver's "sporting spirit", past performances, professional profile, age and any other criteria determined by Porsche from time to time. If a Driver or potential Driver disputes Porsche's determination, the process set out in Section 1.8 shall apply.
- 1.7.4 Porsche reserves the right to amend a Driver's Category at any time (except where a decision on a Driver Protest has been rendered pursuant to Section 1.8.7). Where a decision on Driver Protest has already been rendered pursuant to Section 1.8.7, Porsche shall follow the process set out at Section 1.8.2 for the purposes of amending a Driver's Category.
- 1.7.5 Porsche reserves the right to cease to operate a Category as part of the Championship if there are three or less Drivers in a Category. If Porsche ceases to operate a Category, it shall notify each Driver and each Entrant via a Bulletin. Each Driver shall be offered the opportunity to compete in an alternative Category. If a Driver rejects the opportunity to compete in an alternative Category the Driver shall as its sole right and remedy receive a refund equal to the Registration Fee from Porsche.
- 1.7.6 A Driver may, at any stage in the Season, apply to Porsche to have their Category changed to compete in a higher Category for the same Car only. Porsche shall have sole discretion as to whether to accept any such application from a Driver.
- 1.7.7 Any change to a Driver's Category will not affect the Championship Points or Entrant Points earned by that Driver prior to the Category change. With respect to Category Points, if a Driver's Category is changed at any time (either through Porsche's discretion under Section 1.7.4 or Section 1.7.6, or as a result of a Driver Protest or Porsche Review pursuant to Section 1.8) all Drivers:
- (A) in the Category from which the applicable Driver is moving shall have their Category Points revised to reflect the number of points that they would have obtained had the applicable Driver not competed in that Category that Season; and
 - (B) in the Category to which the applicable Driver is moving (including the Driver that is being moved) shall have their Category Points revised to reflect the Category Points they would have obtained had the applicable Driver competed in that Category from the beginning of that Season.

1.8 Category protests and reviews

- 1.8.1 If any Driver disputes the Category that either they or another Driver has been assigned following review by Porsche under Section 1.7.3, they may protest in writing to the Championship Coordinator no later than 30 minutes after the second Test Session on the Friday Free Practice prior to the seventh Round in which the Driver that is the subject of the protest competes ("**Driver Protest Deadline**"), provided that a £530 ("**Driver Protest Fee**") fee has also been paid by the Driver or the applicable Entrant to the Organising Club (who is receiving the Driver Protest Fee for and on behalf of Porsche) ("**Driver Protest**"). Any failure to pay the Driver Protest Fee prior to a Driver Protest Deadline shall result in the Driver Protest being invalidated.
- 1.8.2 If Porsche, taking into account the circumstances set out at Section 1.7.3, considers that a Driver's Category is incorrect, Porsche may, irrespective of whether a decision has already been rendered under Section 1.8.7 in relation to that Driver, form a Championship Stewards Panel under Section 1.8.3 to make an assessment as to the Driver's correct Category ("**Porsche Review**").
- 1.8.3 Porsche will appoint a Championship Stewards panel consisting of the following Championship Stewards to consider any Driver Protests or Porsche Reviews lodged under Section 1.8.1 or Section 1.8.2 (the "**Panel**"):
- (A) James MacNaughton;
 - (B) Alan Gow (Head of TOCA) and
 - (C) Eddie Corr (Technical Team Manager).

Notwithstanding the foregoing, Porsche reserves the right to amend the composition of the Panel at its sole discretion at any time.

- 1.8.4 Any Driver Protest lodged under Section 1.8.1 must be accompanied by detailed evidence in support of the protest that substantiates the claims made. The Driver that submits the protest must prove, on the balance of probabilities, that the Driver that is the subject of the Driver Protest should, based on their ability relative to the other Drivers in the

EXECUTION VERSION

Championship and the factors set out in Section 1.7.3, have been allocated to a Category different to the Category they were in fact allocated to.

1.8.5 With respect to any Porsche Review lodged under Section 1.8.2, Porsche shall make available to the Panel any evidence that Porsche considers to substantiate Porsche's belief that the Driver's Category is incorrect. The Panel, in determining whether a Porsche Review is upheld, must determine, on the balance of probabilities, that the Driver that is the subject of the Porsche Review should, based on their ability relative to the other Drivers in the Championship and the factors set out in Section 1.7.3, have been allocated to a Category different to the Category they were in fact allocated to.

1.8.6 The Driver who is subject to a Driver Protest or Porsche Review shall have the opportunity to make written submissions to the Panel.

1.8.7 The Panel will consider all Driver Protests and Porsche Reviews and supporting evidence on the papers, without an oral hearing, applying the test set out at Section 1.8.4 or Section 1.8.5 (as applicable), and will determine the protest by majority (no Panel member may abstain). The Championship Coordinator will notify the Driver who submitted the Driver Protest or the Porsche representative that requested the Porsche Review (as applicable), and the Driver who was the subject of the Driver Protest or Porsche Review of the Panel's decision in a Bulletin. Subject to Section 1.8.2, the Panel's decision is final and binding and cannot be appealed.

1.8.8 If a Driver Protest is successful, an amount equal to the Driver Protest Fee shall be returned to the Driver or the Entrant who made the Driver Protest Fee payment.

1.9 Licence and BARC membership

1.9.1 Each Entrant must possess a valid 2024 Motorsport UK National Entrants Licence throughout the Season.

1.9.2 Each Driver must, at the point of submitting their Registration Form and throughout the Season:

(A) be a racing member of BARC;

(B) if competing in a Clubsport Category, be in possession of a valid Motorsport UK Competition Licence (Racing) Race 'Race Club' minimum or equivalent Licence issued by Motorsport Ireland or, if the Driver is registered with a different ASN, meet the requirements set out in Motorsport UK Regulation H25.2.1 to the satisfaction of BARC; and

(C) if competing in a RS Clubsport Category, be in possession of a valid Motorsport UK Competition Licence (Racing) Race 'Race National' minimum or equivalent Licence issued by Motorsport Ireland or, if the Driver is registered with a different ASN, meet the requirements set out in Motorsport UK Regulation H25.2.1 to the satisfaction of BARC.

1.9.3 In addition to Section 1.9.2, each Driver may only compete in a Round if that Driver is registered with Porsche in accordance with these Regulations. Porsche may (at its discretion) permit individuals who satisfy Sections 1.4.5 and 1.9.2 who are not registered as Drivers to participate in Rounds as guest drivers (each, a "**Guest Driver**"), save that Porsche is likely to reject any application by a potential guest driver if such application is for the final Round only. Any obligations that apply to Drivers in Sections 3 to 6 (inclusive) shall apply to Guest Drivers (as relevant).

1.9.4 During the signing-on prior to each Meeting:

(A) each Entrant Manager must present to the Championship Coordinator that Entrant's 2024 Motorsport UK National Entrants Licence;

(B) each Driver must submit to the Championship Coordinator their licence in accordance with Section 1.9.2(B) (which will be returned to the Driver); and

(C) each Driver and/or Entrant Manager must submit to the Championship Coordinator any other documents specified in a Bulletin prior to that Meeting.

1.9.5 The:

(A) Clerk of the Course and/or the Stewards of the Meeting may disqualify from any Event (before, during or, if the results are provisional, after that Event); or

EXECUTION VERSION

(B) the Championship Stewards may disqualify from the Championship as a whole,

any Driver or person connected with an Entrant that they consider as possibly unfit by reason of health, consumption of alcohol or illicit substances, and disqualify any Driver or person connected with an Entrant found smoking and/or using electronic alternatives while participating in any Event.

1.9.6 The Championship Stewards may disqualify from any Event (before, during or after that Event) or from the Championship as a whole any Driver convicted at law of an offence committed during an Event (and shall also report such Driver to Motorsport UK).

1.10 Car

1.10.1 Each Entrant may only permit its Drivers to use, and each Driver is only permitted to use, vehicles in the Championship that:

(A) subject to Section 1.4.12, are listed on the Registration Forms submitted in relation to that Entrant;

(B) if competing in a Clubsport Category, are 718 Cayman GT4 Clubsport cars (Type 982) manufactured in 2019, 2020 or 2021 and complies with Part A of the Technical Regulations (including Part A of Appendix 5); and

(C) if competing in a RS Clubsport Category, are 718 Cayman GT4 RS Clubsport cars (Type 982) manufactured in 2021, 2022 & 2023 and complies with Part B of the Technical Regulations (including Part B of Appendix 5).

1.11 Early registration

1.11.1 Each Driver that submits their Registration Form within certain time periods will be entitled to a credit for their early registration. Please see Section 6.17 for more information.

1.12 Rounds

1.12.1 The Championship will be contested over six Meetings, with the final schedule as follows:

| <u>Rounds</u> | <u>Circuit</u> | <u>Date</u> |
|----------------------|------------------------|------------------------|
| Rounds 1, 2 and 3 | Snetterton (300) | 25 – 26 May 2024 |
| Rounds 4, 5 and 6 | Oulton Park | 22 – 23 June 2024 |
| Rounds 7, 8 and 9 | Croft | 27 - 28 July 2024 |
| Rounds 10, 11 and 12 | Donington Park (GP) | 24 -25 August 2024 |
| Rounds 13, 14 and 15 | Silverstone (National) | 21 - 22 September 2024 |
| Rounds 16, 17 and 18 | Brands Hatch (GP) | 5 -6 October 2024 |

1.12.2 BARC is the Organising Club for all Meetings pursuant to the Championship permit number set out at Section 1.2.1.

1.12.3 Subject to Sections 1.12.4 and 1.19, Porsche may amend the number, composition and location of the Rounds at any stage of the Season and will issue a Bulletin as soon as reasonably practicable to inform Drivers and Entrants accordingly.

1.12.4 If a Round is cancelled due to reasons of safety or force majeure, Porsche may arrange an alternative date on which the Round will take place, in accordance with Motorsport UK Regulation Q7.11.

1.12.5 The length of each Round will be notified to each Driver and each Entrant via a Bulletin prior to that Round.

1.13 Scoring

1.13.1 Subject to Section 3.12, Drivers will be classified for each Round according to the number of laps completed. Drivers having completed the same number of laps will be classified in the order in which they passed the finish line.

Professional Categories

- 1.13.2 Each Driver competing in a Professional Category listed as a classified finisher in the final results of each Round for each Professional Category will be awarded points (the "**Professional Points**") for the following positions in the leader board for that Professional Category as follows:

| Position | Professional Points | Position | Professional Points |
|-----------------|---------------------|-----------------|---------------------|
| 1 st | 10 | 5 th | 4 |
| 2 nd | 8 | 6 th | 3 |
| 3 rd | 6 | 7 th | 2 |
| 4 th | 5 | 8 th | 1 |

- 1.13.3 In addition to Section 1.13.2, the Driver that sets:

- (A) the fastest lap during a Qualification Session in their Professional Category will be awarded one Professional Point for that Meeting; and
- (B) the fastest lap in each Round in their Professional Category will be awarded one Professional Point for that Round, unless the Driver's Car exceeded the Track Limit when the lap time was set, in which case, any such lap time will not be counted for fastest lap purposes.

Such Professional Points will count for the purposes of Section 1.14.1.

- 1.13.4 In addition to Section 1.13.2 and Section 1.13.3, each Driver who:

- (A) earns Professional Points in accordance with Section 1.13.2 and/or and Section 1.13.3 at Round 18 of the Championship; and
- (B) subject to the below, participates in each of Rounds 16, 17 and 18 of the Championship,

shall be awarded 55 additional Professional Points which shall count for the purposes of Section 1.14.1. Notwithstanding (B) above, the Clerk of the Course and/or the Championship Stewards may, in certain exceptional circumstances and at their absolute discretion, permit the award of the additional Professional Points in the event a Driver fails to participate in each of Rounds 16, 17 and 18.

Amateur Categories

- 1.13.5 Each Driver competing in an Amateur Category listed as a classified finisher in the final results of each Round for each Amateur Category will be awarded points (the "**Amateur Points**") for the following positions in the leader board for that Amateur Category as follows:

| Position | Amateur Points | Position | Amateur Points |
|-----------------|----------------|-----------------|----------------|
| 1 st | 10 | 5 th | 4 |
| 2 nd | 8 | 6 th | 3 |
| 3 rd | 6 | 7 th | 2 |
| 4 th | 5 | 8 th | 1 |

- 1.13.6 In addition to Section 1.13.5, the Driver that sets:

- (A) the fastest lap during a Qualification Session in their Amateur Category will be awarded one Amateur Point for that Meeting; and
- (B) the fastest lap in each Round in their Amateur Category will be awarded one Amateur Point for that Round, unless the Driver's Car exceeded the Track Limit when the lap time was set, in which case, any such lap time will not be counted for fastest lap purposes.

EXECUTION VERSION

Such Amateur Points will count for the purposes of Section 1.14.1.

1.13.7 In addition to Section 1.13.5 and Section 1.13.6:

- (A) each Driver who earns Amateur Points in accordance with Section 1.13.5 and/or Section 1.13.6 at Round 18 of the Championship; and
- (B) subject to the below, participates in each of Rounds 16, 17 and 18 of the Championship,

shall be awarded 55 additional Amateur Points which shall count for the purposes of Section 1.14.1. Notwithstanding (B) above, the Clerk of the Course and/or the Championship Stewards may, in certain exceptional circumstances and at their absolute discretion, permit the award of the additional Amateur Points in the event a Driver fails to participate in each of Rounds 16, 17 and 18.

Entrant championships

1.13.8 Porsche shall operate two entrant’s championships: the Clubsport Championship and the RS Clubsport Championship. Each Driver listed as a classified finisher in the final results of each Round, with the Drivers classifications being determined separately for the Clubsport Category and the RS Clubsport Category, will (in addition to their Category Points) be awarded points (the "**Championship Points**") for the following positions in the leader board of the Round as follows:

Championship Points - Clubsport Championship

| Position (taking into account cars which compete in the Clubsport Category only) | Championship Points | Position | Championship Points |
|--|---------------------|------------------|---------------------|
| 1 st | 20 | 9 th | 7 |
| 2 nd | 18 | 10 th | 6 |
| 3 rd | 16 | 11 th | 5 |
| 4 th | 14 | 12 th | 4 |
| 5 th | 12 | 13 th | 3 |
| 6 th | 10 | 14 th | 2 |
| 7 th | 9 | 15 th | 1 |
| 8 th | 8 | | |

Championship Points – RS Clubsport Championship

| Position (taking into account cars which compete in the RS Clubsport Category only) | Championship Points | Position | Championship Points |
|---|---------------------|------------------|---------------------|
| 1 st | 20 | 9 th | 7 |
| 2 nd | 18 | 10 th | 6 |
| 3 rd | 16 | 11 th | 5 |
| 4 th | 14 | 12 th | 4 |
| 5 th | 12 | 13 th | 3 |
| 6 th | 10 | 14 th | 2 |
| 7 th | 9 | 15 th | 1 |
| 8 th | 8 | | |

1.13.9 Prior to the first Round, each Entrant must nominate (in writing to the Championship Coordinator) up to two Cars from its team that compete in a Clubsport Category to score points for the Clubsport Championship and up to two Cars from its team that compete in a RS Clubsport Category to score points for the RS Clubsport Championship (the "**Entrant Points**"). The Entrant Points will be calculated by aggregating the Championship Points accrued by the Driver(s) of such nominated Car(s). An Entrant is not permitted to change its nominated four Cars during the course of the Championship unless a Driver of one of the Entrant's four nominated Cars either leaves the Championship or leaves the Entrant to race for another Entrant within the Championship, and in which case the first Entrant is permitted to nominate either the previously-nominated Car (driven by a new Driver to replace the Driver who has left) or another Car in the Entrant's team (if any).

Additional scoring provisions

1.13.10 Guest Drivers will not be eligible for Championship Points or Category Points and if a Guest Driver represents an Entrant, that Entrant will not be eligible for Entrant Points from the placing of that Guest Driver. For the avoidance of doubt, no Guest Driver is eligible to win prizes under Section 1.14.

1.13.11 If a Driver is disqualified from the Championship:

- (A) they will forfeit all Championship Points and/or Category Points they have accrued;
- (B) they will not be eligible for any prize money; and
- (C) their Entrant will forfeit all Entrant Points accrued due to their participation in the Championship.

For the avoidance of doubt, if a Driver is disqualified from the Championship under this Section 1.13.11, no other Driver's Points or Entrant's Entrant Points will be adjusted as a consequence.

1.13.12 If two or more Drivers in the same Category finish the Championship with the same number of Championship Points or Category Points (as appropriate), the higher place in that Category shall be awarded using the following process:

- (A) by considering the number of first places of the relevant Drivers; and
- (B) in the event there is still a tie, by considering the number of second places and so on until a winner emerges.

Guest Drivers will be removed from the relevant classification(s) prior to making the above consideration.

1.14 Prizes awarded at the end of the Championship

1.14.1 Following the final Meeting of the Season, the Championship Coordinator shall calculate the aggregate of:

- (A) each Driver's Category Points for the Season in accordance with Section 1.13; and

- (B) all points awarded to that Driver in accordance with Section 1.13.3, 1.13.4, 1.13.6 or 1.13.7 (as appropriate), and the three Drivers with the highest aggregate Points in each Category will be awarded the following prizes:

| Position | Professional -Clubsport Category | Amateur - Clubsport Category | Professional -RS Clubsport Category | Amateur – RS Clubsport Category |
|-----------------|--|------------------------------|--|---------------------------------|
| 1 st | Loan of a new Porsche 718 Cayman GTS road car for 1 year (subject to Section 1.14.2) | £5,000 | Loan of a new Porsche 718 Cayman GTS road car for 1 year (subject to Section 1.14.2) | £5,000 |
| 2 nd | £4,000 | £2,000 | £4,000 | £2,000 |
| 3 rd | £2,000 | £1,000 | £2,000 | £1,000 |

1.14.2 The winning Driver in each Professional Category will receive the loan of a new Porsche 718 Cayman GTS for one year from the date of the End of Season Awards, provided that:

- (A) such Driver is resident in the United Kingdom and the Porsche car will only be used by that Driver in the United Kingdom;
- (B) such Driver accepts Porsche's hire terms and conditions; and
- (C) such Driver takes out the insurance policies in relation to that Porsche car as requested by Porsche.

1.14.3 If Porsche appoints a Commercial Partner for the Season that is a watch manufacturer then, for each Category, the Driver that has the fastest lap in the highest number of Rounds for the Championship in that Category may be awarded a watch supplied by that Commercial Partner. For the avoidance of doubt, if Porsche does not appoint a Commercial Partner that is a watch manufacturer (or if Porsche does appoint a Commercial Partner that is a watch manufacturer but that Commercial Partner does not supply watches to Porsche) then no prizes shall be awarded under this Section 1.14.2.

1.14.4 All monetary awards and prizes under this Section 1.14 shall be paid by or on behalf of Porsche by bank transfer to the relevant Driver or Entrant no later than 28 days after the End of Season Awards, using the bank details for the recipient Driver or Entrant set out in the relevant Registration Form, provided that:

- (A) that Driver or Entrant (as relevant) has no outstanding payments due to Porsche;
- (B) that Driver or Entrant (as relevant) has complied with these Regulations;
- (C) in the case of a Driver (or any other Driver), that Driver has no proceedings (including proceedings under Section 2.1) pending that might influence the Championship Points and/or Category Points accrued by that Driver; and
- (D) in the case of an Entrant (or any other Entrant), that Entrant has no proceedings (including proceedings under Section 2.1) pending that might influence the Entrants Points accrued by that Entrant.

1.14.5 Following the final Meeting of the Season, the Championship Coordinator will aggregate the Entrant Points for each Entrant and the three Entrants with the highest number of aggregate Entrant Points may, in the sole discretion of Porsche, each be awarded a prize.

1.15 Presentations

1.15.1 Trophies and sparkling wine are to be provided for a presentation at the end of each Round, which will include:

- (A) a presentation for the three best-placed classified finishers in the Round overall (which, for the avoidance of doubt may include Drivers assigned to the Amateur Category as well as Drivers assigned to the Professional Category); and

- (B) a presentation for the three best-placed classified finishers in the Amateur Category.

1.15.2 In the event that the Championship Points, Category Points and/or Entrant Points for any Round or the Championship are revised by Porsche after the provisional presentations, any Driver and/or Entrant (as relevant) must return to Porsche any awards and prizes wrongly awarded to them within 14 days.

1.15.3 Each award winner under Section 1.14 is required to attend the End of Season Awards on a date and at a venue to be determined by Porsche. Any award winner that fails to attend the End of Season Awards will forfeit their award, unless the Championship Coordinator determines that exceptional circumstances apply.

1.15.4 Certain Drivers may be invited to attend the Porsche Night of Champions event which is held at a location to be confirmed by Porsche around the end of the Season. Each Driver invited to attend such event shall attend that event. Travel and accommodation shall be arranged by Porsche (at Porsche's cost), save that a Driver may arrange their own travel (economy class only) and, provided such cost is approved in advance by Porsche, Porsche shall reimburse the Driver for such cost. If a Driver wishes to bring a guest, the guest's travel and accommodation costs will not be arranged, or paid for, by Porsche.

1.16 **Withholding tax for foreign performers and income tax**

1.16.1 Porsche is obliged under applicable law to make certain withholdings for tax purposes from any payments made to Drivers and/or Entrants based outside of the United Kingdom in respect of their appearances in the United Kingdom (the United Kingdom does not include the Isle of Man, Channel Islands or Eire).

1.16.2 Under certain circumstances, it may be possible for Drivers and Entrants to make a reduced tax payment application to HM Revenue & Customs to reduce the amount of tax withheld by Porsche. For further information, please contact:

Charities, Savings and International 1
HM Revenue & Customs
BX9 1AU
United Kingdom
Tel: 0044 3000 547 395

1.16.3 Each Driver and each Entrant is responsible for any taxes payable on any awards or prizes received by that Driver or Entrant, including income tax.

1.17 **Championship livery**

1.17.1 Porsche will issue per Car:

- (A) one set of Race Numbers and Championship decals prior to the Championship Launch Day; and
- (B) upon request from an Entrant, additional Championship decals in any combination up to a value equal to two full sets of Championship decals (based on Porsche's standard pricing, available on request).

These cannot be modified under any circumstances and should fixing require cutting of the decals to accommodate vehicle shut lines it must be achieved without defacing the logo. If additional or replacement Championship decals are required, they must be ordered prior to the relevant Meeting directly from SDS Racegraphics, the Championship's preferred decal supplier, and fitted in the correct locations set out at Appendix 1 prior to the Qualifying Session of the Meeting.

1.17.2 Each Entrant must ensure that each Car involved in any Event displays the Championship decals in the manner set out in Appendix 1 and no Driver will be permitted to drive a Car that does not comply with the foregoing.

1.17.3 Any additional Championship decals ordered by an Entrant over and above the decals supplied by Porsche for each Car pursuant to Section 1.17.1 will be charged at cost (based on Porsche's standard pricing, available on request), including any delivery costs by Porsche's nominated decal supplier.

1.18 **Timetable regulations**

1.18.1 If fewer than 14 Drivers are expected to participate in a Round then that Round may be re-scheduled for the start or the end of the next scheduled Meeting (in addition to the Round(s) scheduled in that next scheduled Meeting).

EXECUTION VERSION

- 1.18.2 Porsche may amend the timetable for each Meeting at its discretion (including on the instruction of TOCA), subject to Motorsport UK Regulation D25.1.4.
- 1.18.3 Each Entrant and Driver should listen carefully to the Paddock public-address system announcements and the Championship Coordinator regarding the time the Driver is required to be at the assembly area at each Event. Each Entrant and Driver should note that the Driver may be prohibited from taking part in their Qualifying Session or a Round if they are not ready in the assembly area when the Cars are released.
- 1.19 **Postponement, abandonment or cancellation of a Meeting**
- 1.19.1 The Clerk of the Course and/or the Championship Coordinator may postpone or cancel any Meeting in accordance with Motorsport UK Regulation D29.
- 1.19.2 In the event that a Meeting is cancelled, Porsche shall reimburse to each Driver a pro rata proportion of that Driver's Registration Fee (ie, for each Meeting, an amount equal to one sixth of such Registration Fee).
- 1.19.3 In the event that a Round is postponed by more than 12 hours (including in accordance with Section 1.18.1), a Driver may elect not to participate in the re-arranged Round and, if so elected, Porsche shall reimburse that Driver a pro rata proportion of that Driver's Registration Fee (ie, for each Round, an amount equal to one twelfth of such Registration Fee).
- 1.20 **Shareholding**
- 1.20.1 Each Driver, Entrant and Funder represents, warrants and undertakes that, as of the date it submits an application to register for (or otherwise be involved in) the Championship, and on a repeating basis on each day until the end of the Season, it is not a shareholder of any of the following entities:
- (A) Porsche Automobil Holding SE, including its subsidiaries;
 - (B) Federal State of Lower Saxony & companies in which it has a majority holding;
 - (C) State of Qatar & companies in which it has a majority holding; or
 - (D) Companies and Foundations of the Porsche and Piëch families.
- 1.20.2 Each Driver, Entrant and Funder will notify Porsche immediately if it becomes a shareholder of any of the entities referenced in Section 1.20.1.
- 1.20.3 Porsche may terminate any Driver or Entrant's involvement in the Championship with immediate effect at any time by giving written notice to the relevant Driver or Entrant if that Driver or Entrant breaches any of Sections 1.20.1 and/or 1.20.2 above. Porsche may terminate any Driver's involvement in the Championship with immediate effect at any time by giving written notice to the relevant Driver if a relevant Funder breaches any of Sections 1.20.1 and/or 1.20.2 above. If:
- (A) Porsche terminates a Driver's involvement in the Championship then Porsche shall reimburse that Driver (or, as appropriate, the relevant Funder) a pro rata proportion of that Driver's Registration Fee (ie, for each Meeting that has not taken place on the date of such termination, an amount equal to one sixth of such Registration Fee); and
 - (B) Porsche terminates an Entrant's involvement in the Championship then any Drivers registered to that Entrant may apply to change their registration to another Entrant in accordance with Section 1.4.15.
- 1.21 **Racing with Respect**
- 1.21.1 By registering for the Championship, the Driver shall, and shall procure that any member of the Driver's family, the Driver's Entrant and/or any other invitee of the Entrant and/or Driver shall, promote the Championship positively and demonstrate the Motorsport UK's Racing with Respect Code which is appended to these Regulations at Appendix 10.
- 1.21.2 Where any reports of disrespectful conduct are judged to be well founded, the Organising Club and/or Porsche may issue warnings or require remedial actions and/or report the matter to the Championship Stewards who may impose appropriate penalties which can include loss of Points and/or race bans through to expulsion from the Championship and referral to Motorsport UK.

EXECUTION VERSION

1.21.3 It is imperative that Motorsport UK promotes the safety and wellbeing of young people and adults at risk. In addition to this all participants must be aware of their behaviour and conduct at all times and abusive language and harmful behaviour will not be tolerated. Any such incidents must be reported to the Championship Coordinator who will also relay the report to Motorsport UK. Details of the Motorsport UK Policies and Guidelines are available at www.motorsportuk.org/resource-centre by selecting Policies and Guidelines.

1.22 **Code of Conduct for Business Partners**

1.22.1 By registering for the Championship, the Driver shall, and shall procure that any member of the Driver's family, the Driver's Entrant and/or any other invitee of the Entrant and/or Driver shall, (to the extent applicable) comply with Porsche's Code of Conduct for Business Partners which can be found here: <https://www.porsche.com/uk/aboutporsche/overview/compliance/overview/>.

| | |
|----------|----------------------------|
| 2 | JUDICIAL PROCEDURES |
|----------|----------------------------|

2.1 Protests, appeals and investigatory powers

2.1.1 Any protest or appeal against the decision of the Clerk of the Course and/or the Stewards shall be dealt with under Motorsport UK Regulation C. In particular, note:

- (A) the right to protest against another Driver or Entrant, and the process of any such protest, shall be governed by Motorsport UK Regulation C5;
- (B) the rights of appeal against a decision of the Clerk of the Course, and the process of any appeal, shall be governed by Motorsport UK Regulations C6 and C7; and
- (C) Motorsport UK's investigatory powers under Motorsport UK Regulation C9; and
- (D) the right of review set out at Motorsport UK Regulation C14.

2.2 Governing law and jurisdiction

2.2.1 These Regulations shall be governed by and construed in accordance with English law.

2.2.2 Except for matters arising under Section 2.1.1 above and/or Sections 4 and 6 below, any dispute between the parties to these Regulations shall be referred to arbitration before the Motorsport UK National Court (the "**Court**") as a mandatory reference by way of exception under Motorsport UK Regulation A2.4 to the provisions of Motorsport UK Regulation C10 and whereby the process to be adopted shall be determined by the Court taking into account representations of the parties.

2.2.3 The parties to these Regulations agree:

- (A) that any dispute (contractual or non-contractual) arising out of or in connection with Section 6 below shall be submitted to the exclusive jurisdiction of the English courts; and
- (B) in the event that the Court elects not to hear a dispute referred to it pursuant to Section 2.2.2, that dispute (contractual or non-contractual) shall be submitted to the exclusive jurisdiction of the English courts, save that: (a) if a Driver lives in Scotland then they can bring that dispute (contractual or non-contractual) in either the Scottish or English courts; and (b) if a Driver lives in Northern Ireland they can bring that dispute (contractual or non-contractual) in either the Northern Irish or the English courts.

| | |
|----------|------------------------|
| 3 | RACE PROCEDURES |
|----------|------------------------|

3.1 Entries into a Round

3.1.1 There will be a maximum number of Drivers allowed to race in relation to each Round and Friday Free Practice, as determined by the Track Licence for that Track (the "**Track Licence Limit**"). In the event that the number of Drivers wishing to compete in the relevant Meeting or Friday Free Practice exceeds the relevant Track Licence Limit, Porsche or the Organising Club shall notify each Entrant via a Bulletin and the Drivers to be admitted to that Meeting or Friday Free Practice (as applicable) shall be determined as follows:

(A) Porsche and the Organising Club (as applicable) may permit up to 20% more Drivers than the relevant Track Licence Limit to participate in the Qualifying Session or Friday Free Practice (if applicable) prior to the first Round for that Meeting (and if there are more Drivers than the relevant Track Licence Limit plus 20%, Porsche will select and notify via a Bulletin the Drivers who will be permitted to participate in the Qualifying Session or Friday Free Practice based 'first-come-first-served' on the dates that the Drivers submitted their Registration Form); and

(B) the fastest Drivers in that Qualifying Session (irrespective of Category) will qualify for that Meeting.

By way of example only, if the Track Licence Limit is 20 Drivers, Porsche and the Organising Club may permit up to 24 Drivers to participate in the Qualifying Session and the top 20 fastest Drivers in such Qualifying Session shall qualify to compete in that Meeting.

3.1.2 Any Car to be raced by a Driver in a Meeting may only be used to the extent that it passes all Scrutineering (or, if remedied to the satisfaction of the Scrutineers any issues that arise in such Scrutineering prior to use of that Car).

3.2 Signing-on and briefings

3.2.1 Drivers must sign-on at the times advised to them in the Bulletin prior to each Round. Any Driver that fails to sign-on at the correct time may incur a fine of up to £250 for each offence.

3.2.2 Drivers will be informed via a Bulletin of the time and location of the Drivers' Briefing for each Meeting. Drivers' Briefings may be called during a Meeting and, in this case, the Championship Coordinator or their appointed representative will make known the time of that Drivers' Briefing. Attendance at each Drivers' Briefing is mandatory for every Driver participating in that Meeting and any Driver that fails to attend or arrives late may incur a fine of up to £205 for each offence.

3.3 Testing

3.3.1 Porsche shall arrange for Friday Free Practices to take place on the Friday (or any such other date as notified in a Bulletin) prior to each Meeting to give each Driver an opportunity to test their Car in accordance with the terms of this Section 3.3.

3.3.2 Each Driver may participate in each Friday Free Practice, provided that they are eligible to participate in the Round(s) for the relevant Meeting.

3.3.3 Porsche may (but, for the avoidance of doubt, is not obliged to), from time to time, also arrange for Porsche Test Days to take place during the Season to give each Driver an opportunity to test their Car in accordance with the terms of this Section 3.3.

3.3.4 If a Driver causes two stoppages during the course of a Test Session then their continued participation in that Test Session will be at the discretion of the Championship Coordinator.

3.3.5 Should any Test Session be shortened or cancelled at the discretion of the Championship Coordinator (or representative of any other relevant entity) then there will be no refund of any of the Registration Fee paid by (or on behalf of) a Driver.

3.3.6 Only Drivers and Guest Drivers may take part in Friday Free Practices and Porsche Test Days. For Porsche Test Days, subject to the prior approval of Porsche (in its sole discretion), a Driver may be accompanied by their driving coach (who must complete and submit to the Championship Coordinator an Indemnity Form).

3.3.7 Drivers must sign-on at the times advised to them in the Bulletin prior to each Friday Free Practice and Porsche Test Day. Any Driver that fails to sign-on at the correct time may incur a fine of up to £250 for each offence.

EXECUTION VERSION

3.3.8 Save as set out in Sections 3.3.9 and 3.3.10, Drivers may not test (or otherwise race on a track) a Car. For the avoidance of doubt, such restriction includes testing (or otherwise racing on a track) a Car that has been modified such that it no longer qualifies as a "Car" under these Regulations and/or any car that has an identical or substantially similar technical specification to a Car.

3.3.9 Drivers may participate in each Friday Free Practice. In addition, Drivers may test their Cars on Porsche Test Days and Other Test Days, subject to the following conditions:

- (A) each Driver and each Entrant acknowledges that Porsche does not organise, arrange or promote such Other Test Days and accordingly shall have no liability in relation to any injury or damage suffered by any Driver or Entrant in relation to such Other Test Days;
- (B) testing by Drivers after the last round of the 2023 Porsche Sprint Challenge GB Championship is unrestricted until two days prior to the first Meeting of the Championship;
- (C) subject to Sections 3.3.9(D), and 3.3.9(E) below, from the period starting on and from two days prior to the first Meeting of the Championship to the end of the Season, Drivers may participate in the following number of Porsche Test Days and Other Test Days (in addition to Friday Free Practices):

| Category | Maximum number of Porsche Test Days and Other Test Days (in aggregate) |
|-----------------------|--|
| Professional Category | Four days (unless competing in the Championship for the first time, in which case five days) |
| Amateur Category | Unlimited |

- (D) any Driver who has not competed in any Round in the Championship or previous Porsche Sprint Challenge Championships may participate in one additional Porsche Test Day or Other Test Day; and
- (E) for testing on any track not based in the United Kingdom, an unlimited number of Other Test Days are permitted.

3.3.10 Each Driver may participate in:

- (A) the Goodwood Festival of Speed; and
- (B) any other event in which Porsche requires the Driver to perform promotional duties in a Car,

and such participation shall not constitute Other Test Days or Porsche Test Days.

3.3.11 A Driver or Entrant Manager (on the Driver's behalf) must submit to the Event Planner a completed copy of the Testing Form at least 48 hours in advance of each Porsche Test Day and Other Test Day for which that Driver wishes to participate. The Event Planner will confirm receipt of such forms to the relevant Drivers or Entrant Managers (as applicable).

3.3.12 Any Driver that fails to submit (and whose Entrant Manager also fails to submit) a completed Testing Form prior to that Driver participating in a Porsche Test Day or an Other Test Day shall be subject to the following penalties:

- (A) deduction of 44 Championship Points; and/or
- (B) a fine of up to £25,000 (applying Motorsport UK Regulation A.2.4).

3.3.13 Porsche may send representatives to attend any Test Day.

3.4 Qualifying

3.4.1 Each Driver participating in a Meeting shall have the opportunity to participate in a qualifying session on that Track in advance of the first Round of that Meeting (each, a "Qualifying Session").

EXECUTION VERSION

- 3.4.2 The minimum scheduled time for each Qualifying Session will be 20 minutes. Drivers are referred to Motorsport UK Regulation Q12.4 for further rules in relation to the duration of, and participation in, Qualifying Sessions.
- 3.4.3 During any Qualifying Session, Drivers must ensure that their Cars remain in the Pit Lane when not driving on the Track. Cars stationary in the Pit Lane at the end of a Qualifying Session come under Parc Fermé conditions at the showing of the chequered flag in accordance with Section 3.15. At no time will any Car be allowed in the Pit Lane garages or Paddock areas until such time as that Qualifying Session has ended and the Car has cleared any Post-qualification Scrutineering checks by the Scrutineers and been released from Parc Fermé Conditions, except with the express permission of the Clerk of the Course and/or the Eligibility Scrutineer.
- 3.4.4 Subject to Section 3.4.6 and unless otherwise permitted by the Clerk of the Course at their absolute discretion, each Driver must complete a minimum of three laps during each Qualifying Session in the Car to be raced by that Driver at that Track in order to qualify for participation in the Round(s) for that Meeting.
- 3.4.5 The Clerk of the Course may enforce Motorsport UK Regulation Q12.4.3 in the event that a Driver's best lap time in the Qualifying Session exceeds by more than 10% that of the third fastest car within that Driver's Category (where similar weather conditions prevailed).
- 3.4.6 If a Qualifying Session cannot be organised prior to a particular Round due to events outside of Porsche's or the Organising Club's reasonable control, the grid for that Round will be formed according to the then current Championship Points positions. Where there is a tie on Championship Points, the Driver with the best result in the previous Round will take priority.
- 3.4.7 In the event of a driving infringement during the Qualifying Session, the Clerk of the Course may drop a Driver such a number of grid positions for the relevant Round as the Clerk of the Course considers appropriate. Any such incident will normally be investigated after the relevant Qualifying Session.
- 3.4.8 Any Driver taking part in any Qualifying Session who in the opinion of the Clerk of the Course, stops unnecessarily on the Track or unnecessarily impedes another Driver shall be subject to the penalties detailed at Section 4.

3.5 Rounds

- 3.5.1 Each Meeting will be comprised of three Rounds (in addition to a Qualifying Session) Each Round will be run to a maximum timed duration of 20 minutes (or lap equivalent), unless otherwise notified to Entrants via a Bulletin in advance of the relevant Meeting.
- 3.5.2 The Clerk of the Course and/or the Stewards of the Meeting may, at their discretion, reduce the length of any Round and such reduced Round will count as a full Point scoring round.
- 3.5.3 When either the starter or the Clerk of the Course decides a delayed start is necessary, the standard procedure will be as follows:
- (A) 'Start Delayed' board will be displayed by the starter;
 - (B) the Drivers must not stop their engines unless instructed to do so by the Clerk of the Course;
 - (C) the issue that caused the delayed start will be resolved by the Clerk of the Course; and
 - (D) the normal start procedure will apply (including the commencement of a Green Flag Lap(s)).

When the Clerk of the Course notifies the Entrants of a "Start Delayed" situation, the above procedure will automatically apply unless otherwise notified.

3.6 Starting grid

- 3.6.1 The starting grid for the first Round of a Meeting will be formed (subject to the Track Licence Limit regarding the number of starters for that Track) in order of: (i) each Driver who is competing in a RS Clubsport Category's fastest lap during the Qualification Session for that Meeting in accordance with Section 3.4; and thereafter followed by (ii) each Driver who is competing in a Clubsport Category's fastest lap during the Qualification Session for that Meeting in accordance with Section 3.4. The starting grid for such Round will be published as soon as reasonably practicable after the completion of that Qualification Session.

EXECUTION VERSION

- 3.6.2 The starting grid for the second Round of the Meeting will be formed (subject to the Track Licence Limit regarding the number of starters for that Track) from the order determined by: (i) each Driver who is competing in a RS Clubsport Category's second fastest times during the Qualifying Session for the applicable Meeting in accordance with Section 3.4; and thereafter followed by (ii) each Driver who is competing in a Clubsport Category's second fastest lap during the Qualification Session for that Meeting in accordance with Section 3.4. The starting grid for such Round will be published as soon as reasonably practicable after the completion of that Qualification Session.
- 3.6.3 The starting grid for the third Round of the Meeting will be formed (subject to the Track Licence Limit regarding the number of starters for that Track) from: (i) the finishing order of Cars competing in the RS Clubsport Category in the second Round of the applicable Meeting (with any penalties imposed during the second Round of that Meeting applied before the starting grid is formed), subject to Section 3.6.4; and thereafter followed by: (ii) the finishing order of Cars competing in the Clubsport Category in the second Round of the applicable Meeting (with any penalties imposed during the second Round of that Meeting applied before the starting grid is formed), subject to Section 3.6.4.
- 3.6.4 In relation to the RS Clubsport Category and the Clubsport Category respectively, Section 3.6.3 is subject to the following:
- (A) any Driver in the Professional Category who did not finish the second Round of a Meeting, shall start the final Round of that Meeting immediately behind the last Driver starting the final Round (as applicable) (not including any Driver falling under Section 3.6.4(C) or Section 3.6.4(D) below) in the Professional Category (and if more than one Driver in the Professional Category does not finish the second Round then they shall be ordered between them to reflect how long each such Driver remained in the first or second Round (as applicable));
 - (B) any Driver in the Amateur Category who did not finish the second Round of a Meeting, shall start the final Round of that Meeting immediately behind the last Driver starting the final Round (as applicable) (not including any Driver falling under Section 3.6.4(C) or Section 3.6.4(D) below) and if more than one Driver in the Amateur Category does not finish the second Round then they shall be ordered between them to reflect how long each such Driver remained in the first or second Round (as applicable);
 - (C) any Driver that took part in the Qualifying Session for a Meeting (and successfully qualified) but did not start the second Round of a Meeting, will start immediately behind the last Driver starting the final Round of the Meeting in their Category (not including any Driver falling under Section 3.6.4(D) below) if the Driver is to compete in that final Round and if more than one Driver in the Category took part in the Qualifying Session for a Meeting (and successfully qualified) but did not start the second Round of a Meeting, then they shall be ordered between them to reflect the order from the Qualifying Session for that Meeting; and
 - (D) any Driver disqualified from the second Round of a Meeting, may start the final Round of that Meeting, but shall do so immediately behind the last Driver starting the final Round of the Meeting in their Category and if more than one Driver in the Category was disqualified from the first Round of a Meeting, then they shall be ordered between them to reflect the order in which the action causing each Driver's disqualification in the second Round of a Meeting occurred. For the avoidance of doubt, if one Driver was disqualified from the second Round of a Meeting, due to an action on lap 7, whilst another Driver was disqualified due to an action on lap 10, the Driver who was disqualified due to an action on lap 10 would start the final Round ahead of the Driver who was disqualified due to an action on lap 7.

The starting grid for such Round will be published as soon as reasonably practicable after the first Round of the Meeting.

3.7 **Formation Lap**

- 3.7.1 Each Round will be a standing start unless notified via a Bulletin in advance of the relevant Meeting, in which case it will be a rolling start.
- 3.7.2 The grid formation for each Round will be in a 1 x 1 formation.
- 3.7.3 When the signal is given, the Cars will be released onto the Track behind the Safety Car for the Drivers to execute a Formation Lap.
- 3.7.4 During the Formation Lap, Drivers must keep their Cars in formation with no overtaking and the Safety Car will set the pace. Drivers must keep their Cars at (or as close as possible to) the speed of the Safety Car. No practice starts may be executed during the course of the Formation Lap. The Safety Car will stop at the front of the grid and the Drivers will place their Cars in their grid positions behind it. Any Driver unable to join the train of Cars following the Safety Car shall

be held in the Pit Lane and may only start the Round after the last Car to take the start has passed the Pit Lane exit on the first Round lap, but shall only do so under the instructions of the Marshals of the Pit Lane.

3.8 Standing start procedure

3.8.1 This Section 3.8 applies to any Round that has a standing start. For each Round, the standing start will be preceded by a Green Flag Lap unless notified otherwise via a Bulletin in advance of the Round, in which case there will be two Green Flag Laps.

3.8.2 The countdown procedures/audible warnings sequence for each Round shall be as follows:

- (A) there shall be an audible warning two minutes prior to the start of the Green Flag Lap(s). Each Driver must start their Car's engine. Clearing of the grid of persons other than Drivers and Officials shall commence;
- (B) there shall be an audible warning one minute prior to the start of Green Flag Lap(s) and the grid shall be clear save for Officials;
- (C) there shall be an audible warning and a visual warning 30 seconds prior to the start of the Green Flag Lap(s); and
- (D) each Driver will start the Green Flag Lap(s) behind the Safety Car.

3.8.3 There shall be no alterations made to a Car that is being raced in that Round after the audible warning pursuant to Section 3.8.2(B) for that Round and a time penalty of 60 seconds shall be imposed on the Driver of that Car for any breach of this Section 3.8.3.

3.8.4 During the Green Flag Lap(s), the Drivers will keep in formation with no overtaking and the Safety Car will set the pace. Drivers must ensure that their Cars keep to the speed of (or as close as possible to the speed of) the Safety Car.

3.8.5 A five-second board will be shown to indicate that the grid is complete after the Green Flag Lap(s) and the start light sequence is imminent. Approximately five seconds after this board is withdrawn, the red lights will be switched on and, after a further two to seven seconds, the red lights will be switched off to signal the start of the Round.

3.8.6 In the event of any starting lights failure, the starter will revert to use the national flag, after showing a "Start Delayed" board and recommencing the countdown from the one-minute board.

3.8.7 Any Cars pushed from the grid after the two-minute signal or driven into the Pits on the Green Flag Lap(s) shall be held in the Pit Lane and the Drivers of those Cars may only start the Round after the last Car to take the start from the grid has passed the Pit Lane exit on the first Round lap, but shall only do so under the instruction of the Marshals of the Pit Lane.

3.8.8 Any Driver unable to start the Green Flag Lap(s) or start the Round is required to indicate their situation by switching on their hazard warning lights and to comply with Motorsport UK Regulation Q12.11.2.

3.8.9 Any Driver unable to maintain their grid position on the Green Flag Lap(s) to the extent that all other Cars are ahead of him, may complete the Green Flag Lap(s) but must remain at the rear of the last row of the grid but ahead of any Cars to be started with a time delay.

3.8.10 Any Driver deemed to have caused an aborted start must take the restart from the back of the grid. Depending on the layout of the Track for that Round, that Car will either be moved to the back of the grid before the Green Flag Lap(s) commences or the Driver will be instructed to commence the Green Flag Lap(s) from their original grid position. That Driver must, however, during the course of the Green Flag Lap(s), allow Cars starting behind him to overtake, thus ensuring that such Driver takes the restart from the back of the grid. If more than one Driver is penalised in this way then their order at the back of the grid will reflect their relative original grid positions.

3.8.11 Drivers must not during any Green Flag Lap:

- (A) undertake excessive weaving to warm up tyres (excessive is using more than 50% of the Track width);
- (B) fall back in order to accelerate; and/or
- (C) undertake practice starts,

and the Clerk of the Course may apply a 'Drive Through' or time penalty for any breach of the foregoing.

3.9 Rolling start procedure

3.9.1 This Section 3.9 applies to any Round that it has been determined in accordance with Section 3.7.1 will have a rolling start. For each Round, the rolling start will be preceded by a Green Flag Lap unless notified otherwise via a Bulletin in advance of the Round, in which case there will be two Green Flag Laps.

3.9.2 Any Driver unable to start the Green Flag Lap(s) or start the Round is required to indicate their situation by switching on their hazard warning lights and to comply with Motorsport UK Regulation Q12.11.2. Any Driver unable to maintain their grid position on the Green Flag Lap(s), to the extent that all the other Cars are ahead of him, may complete the lap but must remain at the rear without any overtaking. Gaps on the grid will not be filled and Drivers must maintain their allocated position.

3.9.3 The Green Flag Lap(s) will be controlled by the Safety Car.

3.9.4 During the Green Flag Lap(s), Drivers must respect the position of other Drivers around them, remain in their assigned row and not encroach on other Drivers' positions. At the end of the Green Flag Lap(s), the Safety Car will pull into the Pit Lane and the Driver leading the field is responsible for maintaining the speed established by the Safety Car until seeing the red lights go out at the start line.

3.9.5 Drivers must ensure that all Cars are back in perfect grid formation as soon as is reasonably practicable and must be in position at the completion of 50% of the Green Flag Lap(s). The Driver occupying pole position is responsible for setting the distance behind the Safety Car at the completion of 50% of the Green Flag Lap(s) of approximately 30 metres. The Safety Car observer will indicate if the distance is incorrect. The Driver in the outside front row will draw level with the Driver in pole position. All following Drivers will line their Cars up neatly two-by-two, line astern, and approximately five metres behind the Car in front of them. Drivers must maintain their grid positions at the speed determined by the lead Car. Once the Safety Car has pulled into the Pit Lane, each Driver must ensure that their Car passes over their grid slot and continues to maintain the pace of the Safety Car until the red lights are extinguished.

3.9.6 Drivers must not during any Green Flag Lap:

- (A) undertake excessive weaving to warm up tyres (excessive is using more than 50% of the Track width);
- (B) undertake any weaving in the second half of the Green Flag Lap(s);
- (C) fall back in order to accelerate; and/or
- (D) undertake practice starts during a Green Flag Lap(s),

and the Clerk of the Course may apply a 'Drive Through' or time penalty for any breach of the foregoing.

3.9.7 Upon successful completion of the Green Flag Lap(s) the Safety Car will retire to its designated pull-off point and the Drivers will proceed, maintaining constant speed and formation until the signal is given by the starter that the Round shall begin. Should the starter decide that, for whatever reason, the start of the Round should be delayed then the start signal will not be given and one of the following courses of action will be taken:

- (A) if it is deemed safe to do so, the Safety Car will be instructed to remain at the front of the assembled grid for one or more further laps after which the Round may be started;
- (B) if, after the Safety Car has retired and it is deemed safe to do so, the Safety Car will be instructed to re-emerge at the front of the assembled grid and will proceed as in Section 3.9.7(A) above; or
- (C) if after the Safety Car has retired it is not possible to proceed as in Section 3.9.7(B) above, the assembled grid will continue to circulate maintaining constant speed and formation for a further lap with the Driver of the pole position Car setting the pace. The Clerk of the Course will communicate with the start line officials, in order that the start may be given at the end of the lap or the Cars will be brought to a halt on the grid for the Round to be restarted.

3.10 Safety Car

3.10.1 The Safety Car will be operated in accordance with Appendices 3 and 5 to Motorsport UK Regulation Q.

3.11 Stopping a Qualifying Session

3.11.1 Should the need arise to stop a Qualifying Session, red lights will be switched on at the start line and red lights/flags will be waved at all Marshal signalling posts. In this case, Drivers must immediately cease driving at racing speed and proceed slowly without overtaking and with maximum caution to the Pit Lane and be prepared to stop.

3.12 Stopping a Round

3.12.1 If the Clerk of the Course determines that a Round needs to be stopped, red lights will be switched on at the start line and red lights/ flags will be waved at all signalling posts by Marshals. In this case:

- (A) Drivers must immediately cease driving at racing speed and proceed slowly without overtaking and with maximum caution to the starting grid and be prepared to stop;
- (B) the starting grid will automatically become a Parc Fermé;
- (C) Drivers should not drive their Cars into the Pits unless directed to do so by Officials or unless repairs are necessary;
- (D) work on Cars already in the Pits must cease and may only continue when permission to do so has been given by a Scrutineer;
- (E) Drivers may only restart their Cars in the Pit Lane after all other Cars have re-started; and
- (F) non-runners at the time of the stoppage can re-start from the Pit Lane behind those referred to above.

3.12.2 If a Round is stopped with less than two laps having been completed by the leader of that Round:

- (A) that Round will be null and void;
- (B) that Round will restart from the original grid positions;
- (C) gaps on the grid should not be closed up;
- (D) the length of the restarted Round will be determined by the Clerk of the Course whose decision shall be final; and
- (E) in exceptional circumstances the Clerk of the Course may determine not to restart the Round.

3.12.3 If a Round is stopped after more than two laps having been completed by the leader of that Round but with less than 75% of the total distance for the Round having been completed by that leader:

- (A) the grid for the Round restart shall be the order of the Drivers in accordance with Motorsport UK Regulation Q12.15.2;
- (B) the result of the Round will be the finishing order at the end of the restart. The result will not be aggregated. The result will list all Drivers who started in the Round even if they did not take part in the restarted Round and will also use the first part of the Round for purposes of establishing fastest lap point scoring;
- (C) the length of the restarted Round will be determined by the Clerk of the Course. However, in exceptional circumstances the Clerk of the Course may determine not to restart the Round;
- (D) if not restarted, the results will be based on the order of crossing the finish line at one lap less than at the time of the first showing of the red flag and Championship Points and Category Points will be awarded as if the Round had completed with Drivers finishing in that order;
- (E) only Drivers whose Cars are proceeding under their own power, in accordance with Motorsport UK Regulation Q12.24.3(j), at the showing of the red flag will be eligible for Championship Points and/or Category Points;

EXECUTION VERSION

- (F) only Drivers that took part in the original start will be eligible for Championship Points and/or Category Points and then only if they returned to the grid under their own power by an authorised route and were still in the Round at the showing of the red flag; and
- (G) those Drivers not running at the time of the showing of the red flag must go to the Pit Lane if they wish to take the restart after further inspection by Scrutineers.

3.12.4 If a Round is stopped after 75% or more of the total distance for the Round having been completed by the leader of the Round, it shall not be restarted unless determined otherwise in accordance with Motorsport UK Regulation Q12.15.4. If not restarted, the results will be based on the order of crossing the finish line at one lap less than the number of laps completed by the leader at the time of the first showing of the Red light/Flag. Only Drivers whose Cars are proceeding under their own power, in accordance with Motorsport UK Regulation Q12.24.3(j), at the showing of the Red light/Flag will be eligible for Championship Points and/or Category Points. If restarted, the process at Section 3.12.3 will apply.

3.12.5 Drivers are advised that two red light/flag stoppages during a Round may result in that Round being placed at the end of that day's racing, time permitted.

3.12.6 Drivers are advised that should the timetable for the Meeting be running late, the relevant Round may be postponed until later in that day to allow for the feature race to start at its scheduled start time. In addition, the scheduled Round distance may be reduced by the Clerk of the Course in consultation with the Championship Coordinator and with the approval of the Stewards.

3.12.7 If time precludes the running of the second part of a two-part Round (see Section 3.12.3 above) at the end of the day, then the terms of Section 3.5.2 will be used for the purpose of determining the allocation of Points for that Round.

3.13 Re-scrutiny and Driver availability

3.13.1 If a Car is involved in an accident or is modified in any way prior to a Round, the Entrant must submit that Car to the Scrutineers for further examination prior to a Driver using that Car in any Round.

3.13.2 At any time during a Meeting, the Clerk of the Course may order that a Car is subject to further Scrutineering, even if this involves stopping that Car whilst it is being used by a Driver in a Qualification Session or a Round.

3.13.3 If a Driver is involved in a collision or incident during a Round or Qualifying Session, they must not leave the Track (except where medically evacuated) without the consent of the Clerk of the Course, failing which any judicial action against or relating to that Driver may be heard in their absence.

3.13.4 A Driver must remain available at a Meeting until any protest period relating to their Round has elapsed, failing which any judicial action against or relating to that Driver may be heard in their absence.

3.13.5 Cars may not be removed from the Paddock by a Driver during a Meeting after Scrutineering except for the purpose of competing in the Round(s) comprised in the Meeting or with the prior written permission of the relevant Scrutineers and the Clerk of the Course.

3.14 Paddock, Pits and Pit Lane safety

3.14.1 Drivers are referred to Motorsport UK Regulation Q12.25, which must be complied with at all times when in the Pits, Pit Lanes and Paddocks during Meetings.

3.14.2 In relation to all uses of Pit Lanes by Drivers during Meetings (and for the purposes of (A), (C), (D), (F) and (H) in relation to all uses of Pit Lanes by Drivers during Meetings and Test Sessions):

- (A) the outer lane or lanes are to be kept unobstructed to allow safe passage of Cars at all times. Drivers must take due care and drive no faster than the Pit Lane speed limit at any time. Entrants must ensure that all equipment is moved back towards garage entrances as soon as that Driver's Car leaves the Pits during all Qualification Sessions and Rounds;
- (B) admission to the Pit Lane will be by the means of Pit Lane passes valid for that Round only;
- (C) Entrants must ensure that no-one under 16 years of age enters the Pit Lane;

EXECUTION VERSION

- (D) the speed limit is 30 miles per hour (48.2 kilometres per hour) unless notified to Entrants via a Bulletin in advance of the relevant Meeting (or Test Session);
- (E) the Pit Lane will be marked by "pit entry" and "pit exit" boards and the published speed limit will apply between these two marked points;
- (F) the use of radar/speed guns of any type in the Pit Lane is prohibited except for the official radar gun, which will be operated (during a Meeting) by a Judge of Fact;
- (G) failure to comply with the Pit Lane speed limits set out in Section 3.14.2(D) above may result in the imposition of the following penalties on Drivers:
 - (i) Qualifying Session – the Clerk of the Course may impose a fine of £25 for each mile per hour above the Pit Lane speed limit; and
 - (ii) Round – the Clerk of the Course may impose a 'Drive Through' penalty. If the 'Drive Through' penalty cannot be served, the Clerk of the Course may levy a fine of £25 for each mile per hour above the speed limit or impose a retrospective time penalty; and
- (H) Drivers joining a round from the Pit Lane must leave the Pit Lane safely. Whenever reasonably possible, a Marshal with a blue flag will warn of Cars approaching. It is the responsibility of the Entrant to release their Car after a pit stop only when it is safe to do so. Cars in the fast lane have priority over those leaving the working area;
- (I) it is recommended that all personnel wear a high visibility jacket/vest approved by the organisers. During any period of darkness a high visibility jacket/vest is mandatory;
- (J) there must be no more than 3 people on the pit wall, per Car;
- (K) there must be no more than 4 people working on the Car at any one time;
- (L) all equipment and personnel must be in the pit garage when the relevant Car is not making a pit stop, with the exception of pit signallers. Where there are no garages, the Organising Club will notify of Entrants of any changes to pit lane procedures or arrangements which are approved by Motorsport UK; and
- (M) no work may take place on the Car during refuelling and the engine must be switched off.

3.14.3 Each Entrant must ensure that a fire extinguisher (minimum 5 kg or its equivalent) is available within the Car's transporter/awning at each Event.

3.15 Finishes to Qualifying Sessions and Rounds

3.15.1 The provisions in this Section 3.15 apply to each Qualifying Session and Round.

3.15.2 After taking the chequered flag or if the Qualifying Session or Round is declared finished due to a Red Flag, each Driver must progressively and safely slow down, remain behind any Drivers ahead of him, enter the Pit Lane, and proceed directly to the Parc Fermé without stopping unless directed to do so by an Official (and unless notified otherwise in advance by Porsche in a Bulletin: for example, where Porsche agrees there is a danger that Cars might sustain punctures driving back to the Paddock, Porsche may permit Entrants to change the tyres on its Cars in the Pit Lane prior to driving back to the Paddock).

3.15.3 Each Driver must keep their helmet on and their harnesses fastened until they arrive in the Parc Fermé.

3.15.4 The Parc Fermé Conditions will apply in the area between the finish line and the Parc Fermé entrance.

3.15.5 Once in the Parc Fermé after a Round, Drivers finishing first, second and third in each Category must attend the podium presentations and must proceed immediately to the podium.

3.15.6 Only Officials may enter Parc Fermé and no intervention of any kind is allowed unless authorised by such Officials.

3.15.7 Each Driver must ensure that their Car is held in the Parc Fermé or under Parc Fermé Conditions following each Qualifying Session and Round.

EXECUTION VERSION

- 3.15.8 Parc Fermé Conditions will be controlled by a red/green flag system displayed at that Meeting.
- 3.15.9 In the event that a red flag is shown to indicate Parc Fermé Conditions:
- (A) each Driver must ensure that their Car is returned to its awning and left on the ground unless instructed otherwise by an Official;
 - (B) each Driver must then await further instructions from the Scrutineers;
 - (C) no Entrant may work on the Cars of its Driver(s), clean any Car or download any data from any Data System;
 - (D) the personnel of each Entrant are only allowed into the Parc Fermé at the invitation of a Scrutineer. If unauthorised personnel of any Entrant are present in Parc Fermé, they render that Entrant's Driver liable to a fine or exclusion from the Meeting; and
 - (E) Drivers must replace their steering wheels in the Parc Fermé. Any breach of this Section 3.15.9(E) by a Driver shall result in £100 fine,
- (the "**Parc Fermé Conditions**").
- 3.15.10 In the event that a green flag is shown then Cars are no longer under Parc Fermé Conditions.
- 3.16 **Results**
- 3.16.1 Timesheets, grids and Round results are provisional until all Cars involved in the relevant Round have been released by the Scrutineers from the Technical Scrutineering and after the completion of any judicial or technical procedures.
- 3.16.2 The provisional results will be:
- (A) on the website of the Timekeeper within two hours of the end of the relevant Round, unless the circumstances make it impractical to produce the provisional results; and
 - (B) sent by email to each Driver and Entrant Manager within seven days of the end of the relevant Round.
- 3.16.3 Round results will remain provisional until final in accordance with Motorsport UK Regulation D26.3.
- 3.16.4 Final Round results will be communicated via a Bulletin.
- 3.17 **General regulations**
- 3.17.1 If any Driver experiences a serious mechanical problem with their Car at any stage of a Round or Qualifying Session:
- (A) they must leave the Track as soon as it is safe to do so and park their Car in the safest position available, unless doing so causes a hazard to other Drivers;
 - (B) they must, unless in exceptional circumstances or immediate danger, leave their Car in neutral and re-attach the steering wheel before they leave the Car; and
 - (C) they must, unless in exceptional circumstances or immediate danger, stay near the Car to assist recovery crews.
- 3.17.2 In the event of a wet Round or when a Car is running on wet tyres during a Friday Free Practice, the Porsche Test Day, a Qualifying Session or a Round, the Driver must ensure that their Car's headlights and rear lights are illuminated at all times. It is at the discretion of the Clerk of the Course to decide if a Driver should be stopped if their Car's headlights and/or rear lights cease to work. Should a Driver be stopped in these circumstances then the Driver may re-join the Round when the fault is rectified.
- 3.17.3 A Driver may not continue with any Qualifying Session or Round if mechanical assistance is provided in order to move their Car.

EXECUTION VERSION

3.17.4 If a Car sustains radiator damage that affects the conditions of the Track during any Friday Free Practice, Porsche Test Day, Qualifying Session or Round, the relevant Driver must ensure that their Car leaves the Track in a safe position at the earliest opportunity. Failure to do so will result in a fine or grid slot penalty in the next Round.

3.17.5 Porsche may arrange for a tyre raffle at a Meeting. Drivers in all Categories shall be eligible for that tyre raffle.

3.18 Timing modules

3.18.1 Drivers are referred to Motorsport UK Regulation Q12.8.1 in relation to the use of electronic self-identification modules (transponders) (each, a "**Module**") for the purposes of accurate timing. A Module must be obtained by each Driver at their own cost and fitted by each Driver's Entrant to that Driver's Car prior to the Championship Launch Day, wired into a power source in the position and manner to be specified by the Scrutineers. Porsche recommends the specification of the Module to be the MyLaps Direct Powered X2 Racing Transponder, which is available from Timing Solutions Limited, Unit 2, Ninian Park, Ninian Way, Tamworth, Staffordshire, B77 5ES (telephone: 01827 285666).

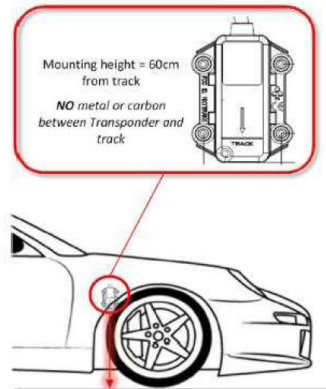

3.18.2 The Modules must be in place and functioning correctly during all Meetings and must also be used by Drivers at Friday Free Practices, Porsche Test Days and the Championship Launch Day. In the event that the Module is not installed and/or functioning at an Event or at the Championship Launch Day, Porsche shall fine the Driver's Entrant (or Driver, if the Driver of the Car does not represent an Entrant) £500 for each instance of non-compliance.

3.18.3 The setting and servicing of the Modules must be only carried out by properly authorised Motorsport UK-licensed timekeepers.

3.18.4 Each Entrant (or Driver, if a Driver does not represent an Entrant) must submit to the Championship Coordinator the number of the Module fitted to its Car(s) no later than seven days before the Championship Launch Day. If for any reason the Module fitted to a Car is changed, the relevant Entrant (or Driver, if the Driver of the Car does not represent an Entrant) must submit to the Championship Coordinator the number of the new Module fitted to its Car no later than one day before the next Event. Failure to notify Porsche in accordance with the requirements of this Section 3.18.4 shall result in a £500 fine for the Driver's Entrant (or Driver, if the Driver of the Car does not represent an Entrant).

3.18.5 Drivers will be responsible for repair or replacement of the Modules due to accidental damage, misuse or loss at any time during the Season.

3.19 Adverse weather conditions

3.19.1 If there is a change in weather conditions after leaving the assembly area and before a Round starts, the start of such Round will be delayed. In these circumstances, each Driver will be allowed to change their Car's tyres from dry to wet and will be permitted one reconnaissance lap prior to the Round. After a maximum of five minutes, the countdown will resume from a five minute signal.

3.20 Alcohol breathalyser test

3.20.1 As a condition of participation in each Meeting and Friday Free Practice, all Drivers shall submit themselves to an alcohol breathalyser test in accordance with this Section 3.20.

3.20.2 Up to five Drivers each day of a Meeting and Friday Free Practice shall be randomly selected to be tested at a time to be selected by the Championship Coordinator.

EXECUTION VERSION

- 3.20.3 The breathalysers used for testing by the Championship Coordinator will be 'AlcoSense Ultra' breathalysers within valid calibration periods of their current calibration certificates. Calibration and maintenance of such devices will be undertaken by AlcoSense Breathalysers.
- 3.20.4 All Drivers are required to maintain a Zero Alcohol Level at all times throughout the Meeting and each Friday Free Practice. To avoid the possibility of a 'false-positive' reading, a "**Zero Alcohol Level**" is defined as a reading of less than 0.02%BAC, meaning that a reading of less than 0.02%BAC is a "**Satisfy**" and a reading greater than or equal to 0.02%BAC is a "**Fail**".
- 3.20.5 Drivers must declare and show proof in writing of any medical condition and/or medications that could compromise any test (or result in a false-positive reading) under this Section 3.20 to the Championship Coordinator at least 48 hours before the start of the relevant Meeting.
- 3.20.6 Any Driver who Fails the mandatory test is not permitted to participate in any on-track sessions that day until they Satisfy the Zero Alcohol Level. Such Driver may request a re-test 30 minutes after the failure (or sooner if the next on-track session is within 60 minutes). If that Driver fails that second test they remain ineligible to compete but may request an additional alcohol test no later than 30 minutes before each on-track session of that day. Such Driver will only be allowed to compete in an on-track session if they Satisfy the final test prior to such on-track session.
- 3.20.7 Should a Driver not participate in either a Qualifying Session or a Round due to failure of any breathalyser test set out above, any further participation in that day's on-track sessions shall be at the sole discretion of the Clerk of the Course.
- 3.20.8 In addition to the mandatory test times to be determined under Section 3.20.2, the Clerk of the Course and/or the Championship Coordinator may, at their sole discretion, direct that a re-test be carried out on any Driver at any time during any Meeting or Friday Free Practice should they consider that there are grounds for doing so.
- 3.20.9 A Driver may also confidentially request a test to be carried out on a particular Driver at any time during the Meeting or Friday Free Practice should they have reasonable belief that such Driver may be over the Zero Alcohol Level. This request must be made in writing to the Clerk of the Course and/or Championship Coordinator, who will not unreasonably refuse such first request.
- 3.20.10 If a Driver Satisfies the mandatory test but Fails a subsequent breathalyser re-test on the same day, that Driver will be immediately disqualified from that day's on-track sessions.
- 3.20.11 The results of all breathalyser tests remain confidential between the Championship Coordinator, the Clerk of the Course and the relevant Driver, save that future Bulletins may include references to any Driver that is disqualified from any on-track session(s) and information may be shared with third parties as required by the Regulations, Motorsport UK Regulations or applicable law.
- 3.20.12 If a Driver fails a breathalyser test under this Section 3.20 then they may require one prompt re-test to be taken using another approved device (such request only to be made once per day).
- 3.20.13 If a Driver refuses to participate in any breathalyser test under this Section 3.20, they will be treated as having Failed and the Driver shall be disqualified from participation in that day's on-track sessions.
- 3.20.14 Each Entrant acknowledges and agrees that the Clerk of the Course and/or the Championship Coordinator may also require that Entrant's Senior Entrant Personnel to submit at any time during a Friday Test Day and/or Meeting to a breathalyser test. The terms of Sections 3.20.3 to 3.20.13 (inclusive) shall apply to any Senior Entrant Personnel (save only for necessary changes for such Sections to apply in this context).
- 3.20.15 Each Driver acknowledges and agrees that if they are prohibited from participating in any part (or all) of the Championship in accordance with this Section 3.20, they shall not be entitled to any refund of the Registration Fee.
- 3.21 **Tail lifts**
- 3.21.1 No Entrant may lower the tail lift on any trucks within its control at a Track until and except as advised by Porsche via a Bulletin prior to the Meeting. Any Entrant that fails to comply with the foregoing will incur a fine of £500.

| | |
|----------|------------------|
| 4 | PENALTIES |
|----------|------------------|

4.1 Infringement of Technical Regulations

4.1.1 Any Driver whose Car is deemed to be ineligible under the Technical Regulations will be subject to the penalties laid down by the Motorsport UK Regulations except where amended by these Regulations. In addition the Championship Stewards may, at their discretion, apply an increased penalty which could include exclusion from part or all of the Championship.

4.1.2 At any time during a Meeting and if applicable any Friday Free Practice, each Car will be subject to Eligibility Scrutineering and Technical Scrutineering in accordance with the Motorsport UK Regulations (including Motorsport UK Regulations D33, D11.2 and J3.1). In particular:

(A) Cars are subject to Technical Scrutineering during each Friday Free Practice; and

(B) Cars are subject to Eligibility Scrutineering after each Qualification Session (the "**Post-qualification Scrutineering**") and each Round (the "**Post-Round Scrutineering**").

4.1.3 No Car shall compete in four consecutive Meetings without undergoing Scrutineering.

4.1.4 The timing of Scrutineering during each Event will be notified via a Bulletin issued prior to that Event. No Car which has been requested for Scrutineering may be driven by a Driver in a Qualifying Session or a Round (as applicable) until it has been approved by the applicable Motorsport UK Scrutineer. Any Car which is selected for Post-Round Scrutineering after the end of the final Round of a Meeting must not be taken away from the applicable Circuit until the Car has completed the Scrutineering checks and has been released from Parc Fermé.

4.1.5 Each Entrant must ensure that any of its Cars that fail any Technical Scrutineering must comply with the requirements of the Motorsport UK Scrutineers before that Car can be driven by a Driver in a Qualifying Session or a Round.

4.1.6 If any Car fails the Post-qualification Scrutineering and/or Post-Round Scrutineering then that Driver's performance in the relevant Qualification Session or Round (as applicable) will be invalid and the relevant Entrant shall be penalised by the deduction of six Entrant Points, even if this results in a negative Entrant Points total. That Car will only be permitted to be raced in (in the case of a Post-qualification Scrutineering failure) the first Round of that Meeting and/or in (in the case of a Post-Round Scrutineering failure after the first Round or second Round of a Meeting) the next following Round of that Meeting, if the Entrant submits that Car and a copy of the technical non-compliance report for re-Scrutineering by the Eligibility Scrutineers no later than 40 minutes before the start of the applicable Round. If that Car passes such re-Scrutineering, the relevant Driver may start the applicable Round with that Car from the back of the grid 10 seconds after the official starting signal has been given. If that Car does not pass such re-Scrutineering, that Car may not be raced for the remainder of that Meeting.

4.1.7 If:

(A) a Car fails the Post-qualification Scrutineering and the relevant Driver does not submit that Car for re-Scrutineering prior to the relevant Round;

(B) a Car fails the Post-qualification Scrutineering and subsequently fails the re-Scrutineering prior to the relevant Round; or

(C) a Car fails the Post-Round Scrutineering,

then (in addition to any penalties set out at Section 4.1.6 (where applicable)) the penalties set out in Motorsport UK Regulation C3.5.1(a) and (b) shall apply and, if the Clerk of the Course deems the infringement to be of a serious nature, Motorsport UK Regulation C3.5.1(c) shall also apply.

4.1.8 Scrutineers may require a Car to be dismantled by the Driver or the relevant Entrant in order to check its eligibility or suitability as and when directed by the Scrutineers. A Car (or a component of that Car) may be sealed for subsequent technical examination and, if so, the Scrutineers will state to that Car's Driver the date and time that such Car or component must be made available for inspection. If such Car or component is not made available at that date and time, the penalties set out in Motorsport UK Regulation C3.5.1 shall apply.

4.2 **Infringements of non-Technical Regulations**

4.2.1 Any Driver that commits a driving offence during a Qualification Session and/or a Round is subject to the penalties set out in the Motorsport UK Regulations, including:

- (A) the penalties set out in Motorsport UK Regulation C2;
- (B) the time penalty set out in Motorsport UK Regulation Q12.14; and
- (C) the 'Stop-Go' penalty and/or the 'Drive Through' penalty set out in Motorsport UK Regulation Q12.26.

4.2.2 In addition to Section 4.2.1, the Clerk of the Course may impose additional sanctions for driving offences in accordance with the terms of these Regulations. In particular, if a Driver commits a false start as set out in Motorsport UK Regulation Q12.13 then the Clerk of the Course will impose a time penalty of 10 seconds in accordance with Motorsport UK Regulation Q12.14.

4.2.3 Any Driver found guilty of a driving offence by Motorsport UK that generates penalty points under Motorsport UK Regulations C2, at the discretion of the Clerk of the Course, will also have Championship Points and Category Points deducted in line with the severity of any penalty imposed by Motorsport UK, such that if Motorsport UK imposes:

- (A) a formal written reprimand, that Driver will be deducted two Championship Points and two Category Points;
- (B) a fine, time, grid place or position/lap penalty (unless imposed for gaining an unfair advantage in accordance with Motorsport UK Regulation C2.3), that Driver will be deducted three Championship Points and three Category Points;
- (C) a disqualification from any Event, that Driver will be deducted four Championship Points and four Category Points; and
- (D) a disqualification from a Meeting, that Driver will be deducted six Championship Points and six Category Points,

and if a Driver is punished for a reasonably similar offence by Motorsport UK for a second time, the Championship Points and Category Points deductions will be double, if a Driver is punished for a reasonably similar offence by Motorsport UK for a third time, the Championship Points and Category Points deductions will be triple, and so on.

4.2.4 In addition to any sanction imposed under the Motorsport UK Regulations, at the discretion of the Clerk of the Course, a Driver will be deducted Championship Points and Category Points for the following offences:

- (A) failing to attend a Drivers' Briefing: one Championship Point and one Category Point;
- (B) failing to comply with the responsibilities set out at Motorsport UK Regulations H32.1.1 to 32.1.7 (inclusive): six Championship Points and six Category Points; and
- (C) any Driver and/or any member of the Driver's family, the Driver's Entrant and/or any other invitee of the Entrant and/or Driver using abusive language or behaviour, physical assault or threats of physical assault towards anyone present at the relevant Event in accordance with Motorsport UK Regulation C1.1.9: nine Championship Points and nine Category Points,

and if a Driver (and/or, in the case of (C) above, any member of the Driver's family, the Driver's Entrant and/or any other invitee of the Entrant and/or Driver) commits any of the offences above for a second time, the Championship Points and Category Points deductions will be double, if a Driver (and/or, in the case of (C) above, any member of the Driver's family, the Driver's Entrant and/or any other invitee of the Entrant and/or Driver) commits any of the offences above for a third time, the Championship Points and Category Points deductions will be triple, and so on.

4.2.5 In addition to the above:

- (A) any other breaches of these Regulations and/or the Motorsport UK Regulations by a Driver; and
- (B) any conduct by a Driver that a Steward, the Clerk of the Course or the Championship Coordinator deems to be unacceptable,

EXECUTION VERSION

may result in a deduction of Championship Points and Category Points by the Clerk of the Course.

- 4.2.6 The Clerk of the Course may impose a 'Stop-Go' penalty or a 'Drive Through' penalty where indicated in these Regulations and, in addition, whenever a Driver is deemed to have gained an unfair advantage or who repeatedly exceeds the Track limits. Any Driver subject to a 'Stop-Go' penalty or 'Drive Through' penalty imposed by the Clerk of the Course will comply with Motorsport UK Regulation Q12.26.
- 4.2.7 Any Driver alleged to have committed a driving offence may be called to a meeting with the Stewards who may take further action. The Clerk of the Course may use video evidence and/or data logging evidence at their discretion.
- 4.2.8 As long as the results of a Meeting are still provisional in accordance with Section 3.16.3, the Championship Coordinator may, within 14 days of that Meeting, ask the Championship Stewards to investigate any incident even if the Clerk of the Course and/or the Stewards of that Meeting have already investigated the incident. The Championship Stewards will be empowered to take further action. In addition, Motorsport UK may call an inquiry into the matter under Motorsport UK Regulation A3.1(ii).
- 4.2.9 The Clerk of the Course or the Championship Co-ordinator (as applicable) may impose the following penalties on any Driver who is reported to be involved cases of avoidable contact between Cars:
- (A) if the contact occurs during a Friday Free Practice or Porsche Test Day, the Driver concerned shall be black flagged and subsequently may be prevented from taking any further part in that Friday Free Practice or Porsche Test Day, unless the Championship Coordinator decides that there are exceptional circumstances not to do so;
 - (B) if the contact occurs during a Qualifying Session or Round, the Driver concerned may be penalised by the way of a 'Drive Through' penalty unless the Clerk of the Course determines that exceptional circumstances apply.
- 4.2.10 Any Driver who exceeds the limit of the Track should only re-join when safe to do so and without gaining an advantage.
- 4.2.11 In addition to a 'Drive Through' penalty or 'Stop-Go' penalty, a Driver may also be subject to penalties in accordance with Motorsport UK Regulations Q12.17 to Q12.23 (inclusive).

5 TECHNICAL REGULATIONS

PART A OF THE TECHNICAL REGULATIONS SHALL APPLY IF A DRIVER IS COMPETING IN THE CHAMPIONSHIP IN A CLUBSPORT CATEGORY IN A PORSCHE 718 CAYMAN GT4 CLUBSPORT CAR (TYPE 982) MANUFACTURED IN 2019, 2020 OR 2021. REFERENCES TO "CAR" IN PART A SHALL BE TO THE 718 CAYMAN GT4 CLUBSPORT CAR (TYPE 982).

PART B OF THE TECHNICAL REGULATIONS SHALL APPLY IF A DRIVER IS COMPETING IN THE CHAMPIONSHIP IN A RS CLUBSPORT CATEGORY IN A 718 CAYMAN GT4 RS CLUBSPORT CARS (TYPE 982) MANUFACTURED IN 2021, 2022 OR 2023. ALL REFERENCES TO "CAR" IN PART B SHALL BE TO THE 718 CAYMAN GT4 RS CLUBSPORT CAR (TYPE 982).

PART A – PORSCHE 718 CAYMAN GT4 CLUBSPORT**5.1 Introduction**

- 5.1.1 The Technical Regulations are set out in accordance with Motorsport UK's specified format. The Technical Regulations apply in addition to Motorsport UK Regulations J, K (as applicable to the Championship) and Q with which shall each Driver and Entrant shall comply.
- 5.1.2 Save for Sections that are expressly stated to apply in a narrower or wider context, each Entrant must procure that its Drivers, and each Driver shall, only drive Cars in Meetings that comply with Section 1.10 and this Part A of Section 5. No Entrant may make any modifications to a Car save as expressly set out in this Part A of Section 5 or otherwise expressly agreed in advance by the Championship Coordinator.
- 5.1.3 Each Car must comply with the description set out in Appendix 5.
- 5.1.4 All part numbers set out in this Part A of Section 5 are subject to change at Porsche's sole discretion from time to time.
- 5.1.5 The chassis of each Car must be registered on the Porsche Motorsport Racecar Service Information (PMRSI) prior to the Championship Launch Day. As a result of registering on the PMRSI, Porsche may send bulletins from time to time which require confirmation of an action relating to a Car. All steps required to be taken by the PMRSI must be carried out prior to each Event. The Scrutineer may, at its sole discretion, issue a technical non-compliance and prevent a Car from being used at an Event in the event that the action required via the PMRSI has not been taken prior to the Event.

5.2 Safety requirements

- 5.2.1 The design and fixation of the roll cage of a Car must remain unmodified from the original version of that Car. The Entrant must provide a copy of the roll cage certificate to the Scrutineers prior to the first Meeting.
- 5.2.2 The service interval of the fuel cell (FT3 safety fuel cell) of a Car must be maintained. The Entrant must provide a copy of the documents supplied to the Scrutineers prior to the first Meeting.
- 5.2.3 Fire extinguisher – a standard fire extinguisher system, which meets the provisions set out in Motorsport UK Regulation K3.1, plumbed-in for discharge into both cockpit and engine compartment, must be fitted to each Car. The fire extinguisher fitted must be of the type and specification as originally supplied with the Car.
- 5.2.4 Towing eyes – the towing eyes supplied when a Car was originally built by Porsche (or the Porsche Group) must be properly mounted and clearly marked in that Car in accordance with Motorsport UK Regulations Q13.1.3.
- 5.2.5 Drivers must wear the following items:
- (A) clean flame-resistant overalls in accordance with FIA Standard 8856 – 2000 or FIA Standard 8856 – 2018;
 - (B) clean flame-resistant underwear (with long arms and legs) in accordance with FIA Standard 8856 – 2000 or FIA Standard 8856 – 2018;
 - (C) clean flame-resistant balaclava in accordance with FIA Standard 8856 – 2000 or FIA Standard 8856 – 2018;
 - (D) clean flame-resistant socks and shoes in accordance with FIA Standard 8856 – 2000 or FIA Standard 8856 – 2018;
 - (E) clean flame-resistant gloves in accordance with FIA Standard 8856 – 2000 or FIA Standard 8856 – 2018; and
 - (F) a helmet including HANS clips in accordance with FIA Regulations (Appendix L to the International Sporting Code).
- 5.2.6 Drivers must fasten and secure a six-point SCHROTH seat belt with FIA homologation in accordance with FIA-standard 8853 – 2016 and Motorsport UK Regulation K2.1.7.
- 5.2.7 Frontal head restraint system ("FHR"): the use of an FIA approved FHR (HANS or other comparable device) in accordance with FIA list no. 29 is compulsory in each Car. The certificate of the manufacturer of the FHR must be presented during Eligibility Scrutineering.

EXECUTION VERSION

5.2.8 Each Car must be fitted with Safety Nets and fitted in accordance with Porsche (or Porsche Group) instructions. The following parts are to be fitted:

- (A) AS Safety Net Side 9917225217A;
- (B) Threaded Pin Net 9F0857973;
- (C) AS Safety Net Center 9917225237A;
- (D) Bent Attachment Safety Cage 9917225137C;
- (E) Pan-Head Screw M6X20 N10653601;

5.2.9 The seat in each Car must be a standard Recaro seat with FIA homologation in accordance with FIA standard 8862-2009. Adjustments of any such seat by removing or adding padding material are only permitted by utilising the following systems:

- (A) Corbeau Pro-Seat BN 3795 covered in black nylon with accompanying certificate of conformance (or padding sourced from an alternative supplier as long it conforms to the flammability standards of FIA standard 8862-2009, and is the same colour and made of the same material as the original equipment);
- (B) the removal of the entire padding system in the seat is not permitted. A minimum padding thickness of 10mm must be maintained as must the original upholstery and the requirements of the below diagram must be complied with. The seat structure and seat rails must remain unmodified. Padding must not obscure any branding on the seat. Padding must not be fitted higher than the shoulder wings on the standard fit seat; and

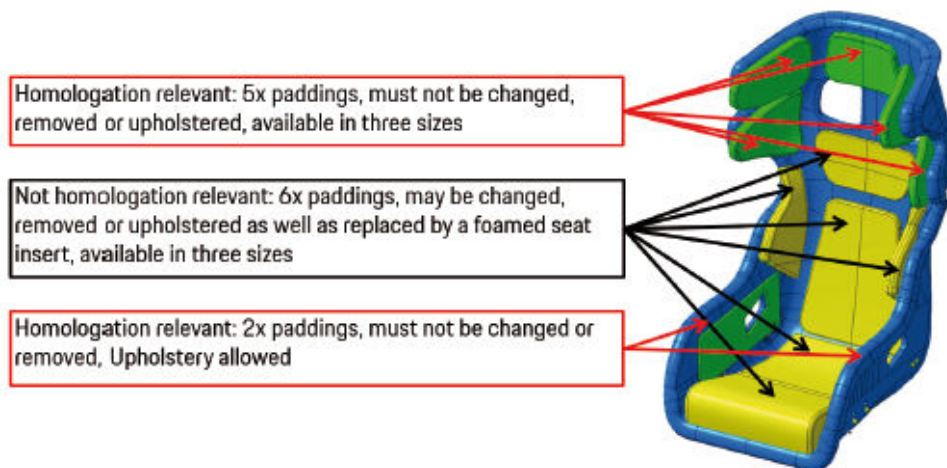

- (C) a drinking system without an electric pump may be used. Prior to use it must be approved by Eligibility Scrutineers.

5.2.10 A cool suit may be used by each Driver provided that it is approved in advance of use by the Eligibility Scrutineers.

5.2.11 Any biometric or physiological monitoring device worn by a Driver must comply with the safety regulations set out in these Regulations, the Motorsport UK Regulations and the FIA Regulations and be declared to the Eligibility Scrutineers, who in conjunction with the Medical Adviser will make the final decision about its use. Any data recorded must be shared in full with Porsche and the Medical Adviser.

5.2.12 Championship fireproof badges must be attached to the Driver's Race Suits (as specified in Appendix 4). The Championship Coordinator will provide such fireproof badges to each Entrant. As an alternative, such badges may be embroidered into the Driver's Race Suit by the Race Suit manufacturer provided they are embroidered using fireproof material.

5.3 Permitted modifications and built-in components

5.3.1 Subject to Section 5.3.2 of this Part A, modification to a Car that is part of the regular maintenance of that Car or that serves for the replacement of parts that have become defective as a result of wear or an accident is permitted.

5.3.2 Any modifications under Section 5.3.1 of this Part A are only permitted within the scope defined below:

EXECUTION VERSION

- (A) parts damaged as a result of wear or accidents may only be replaced by genuine Porsche parts, which are dedicated to the Porsche 718 Cayman GT4 Clubsport;
- (B) the use of any component manufactured by Porsche (or the Porsche Group) that is not a component that forms part of the Porsche 718 Cayman GT4 Clubsport as delivered by Porsche is prohibited;
- (C) standard fasteners such as screws, nuts bolts, washers, circlips spring washers, split pins may only be replaced with genuine Porsche parts; and
- (D) in case of threads, the thread type, size and pitch (e.g. M8 x 1.25) are to be retained.

5.3.3 The fitment of a mesh guard set for the air intakes on the Left and Right Hand Side of the Porsche 718 Cayman GT4 Clubsport is mandatory. Only Mesh Air Intake guards as supplied by Manthey Racing or Porsche Motorsport with the Part Numbers MTH541561 (LH) & MTH541562 (RH) are to be fitted. (figure 2) All other mesh and grille material is prohibited.

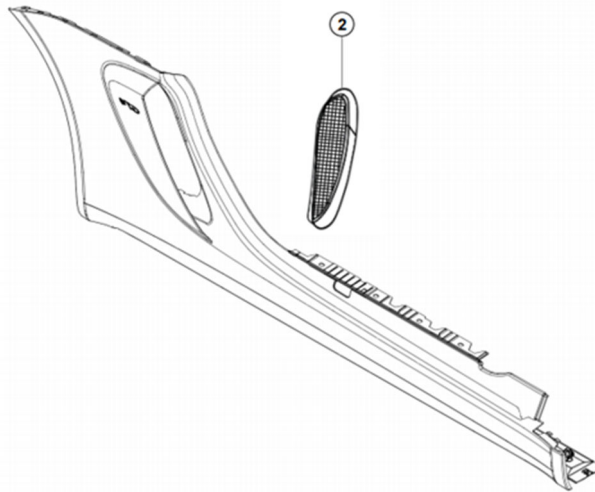

- 5.3.4 Every type of machining, additional fitting of seals, welding, strengthening, polishing, sanding, coating and every type of other possible change to an original part of a Car is forbidden.
- 5.3.5 Any technical information and safety guideline included in Bulletins must be strictly observed and obeyed.
- 5.3.6 No Car may have coloured headlight covers. Headlights can be protected with a suitable clear material which must: (i) be fitted on an unused headlight; and (ii) have no impact on the functionality of the headlights.
- 5.4 **Weight**
- 5.4.1 The combined weight of a Car and its Driver (including their personal equipment as it is worn in the Car whilst driven on track) must not be less than 1,400kg. For these purposes, liquids and oils are to be set within their operational levels and the Car is to be fitted with declared tyres.
- 5.4.2 The only method for removing fuel from the Car for scrutineering is as set out at Section 5.17 of this Part A.
- 5.4.3 The following are to be included when checking the combined weight of a Car:
- (A) the Video Data Logger; and
 - (B) the Broadcaster's Camera (if designated to the Driver).
- 5.4.4 When requested by any Championship official or Scrutineer, each Driver must present themselves and their car to the official scale of the Championship (in a location to be notified by Porsche). If the weight of the Car and Driver (including their personal equipment as it is worn in the Car) is less than 1,400kg, then equalisation weight in the form of Porsche ballast plates must be fitted. Part numbers as per the latest parts manual on PMRSI.

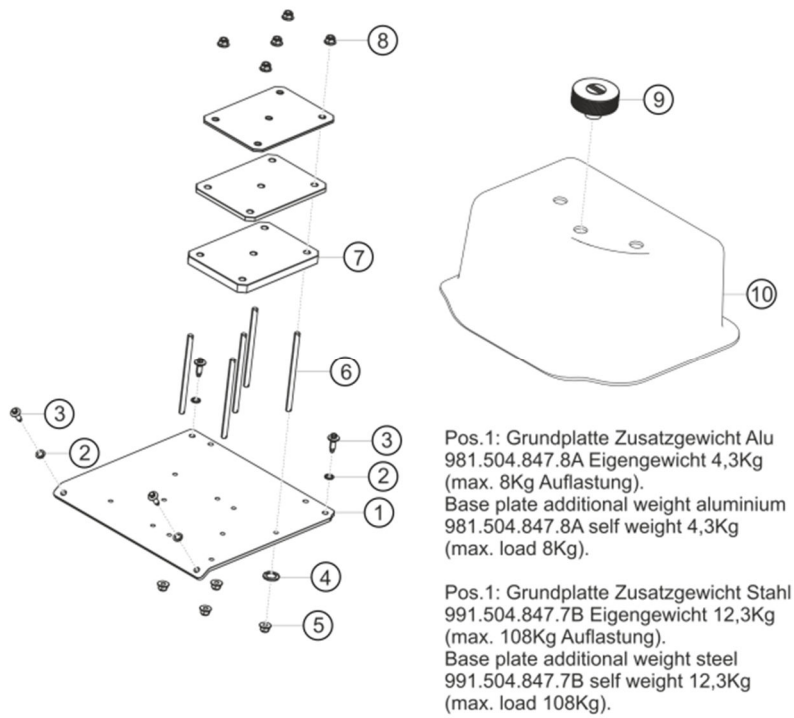

5.4.5 The official scales of the Championship will be in a location to be notified by Porsche. Alternative certified scales will be nominated by the Technical Team in the event of the official scales of the Championship not being available.

5.5 **Ground clearance**

5.5.1 Each Car must have a minimum ride height of 83mm front and 100mm rear. This is to be checked with the Driver including their or her personal equipment as it is worn in the Car whilst driven on a Track. Declared tyres are to be fitted and set to 2.0 bar (+/-0.1 bar). The points of measurement are as illustrated below for both the front and rear axle.

Front axle

Rear axle

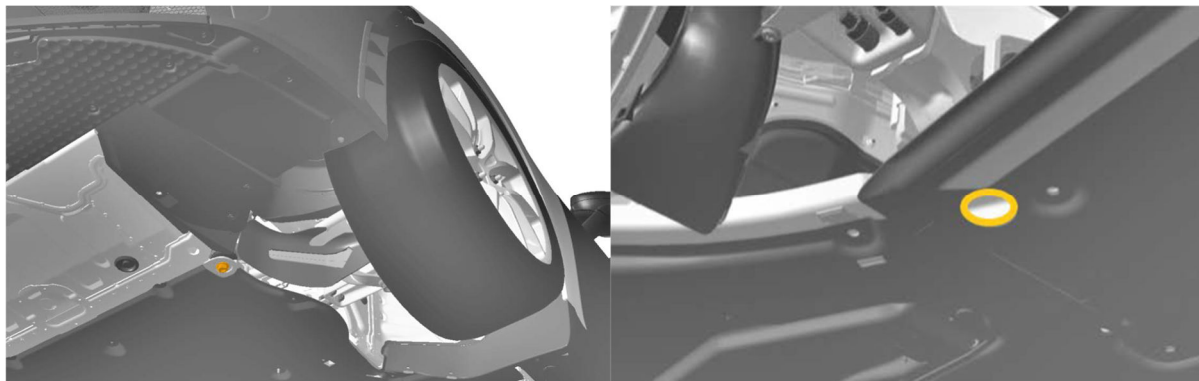

5.5.2 Changing the ride height of a Car by altering the adjustment nuts on the suspension struts is not permitted during Qualifying Sessions and/or Rounds.

5.5.3 The official flat patch of Porsche will be located in an area to be nominated by Porsche.

5.6 **Brakes**

5.6.1 Only the following brake callipers are permitted to be used on a Car:

LF: 9F2615123

RF: 9F2615124

LR: 9F2615423

EXECUTION VERSION

RR: 9F2615424

5.6.2 The following knock-back springs are to be fitted under each piston of all brake callipers on each Car. Modification of these springs is prohibited.

Front: 991.351.963.8A

Rear: 991.352.963.8A

5.6.3 Only the following front brake discs and pads are permitted on each Car:

LF: 9F2615283

RF: 9F2615284

Racing brake pads: 991.351.942.8A or 991.351942.8B

5.6.4 Only the following rear brake discs and pads are permitted on each Car:

LR: 9F2615583

RR: 9F2615584

Racing brake pads: 9F2615117 or 9F2615117A

5.6.5 Only the following brake master cylinders are permitted on each Car:

Front: 17.8 mm diameter 991.355.170.8E

Rear: 17.8 mm diameter 991.355.170.8E

5.6.6 Only performance friction racing brake fluid -325 (DOT 4) is to be used in the brake and clutch hydraulic systems in each Car.

5.7 **Steering and suspension**

5.7.1 Suspension adjustments to a Car may only be made within the limits of the existing adjustment ranges of the Car. All genuine Porsche 718 Cayman GT4 Clubsport Car parts must be retained.

5.7.2 Unless otherwise notified via a Bulletin or in this Section 5.7.2 of this Part A, the maximum thickness of the spacer washers within the front and rear axle control arms in each Car are:

Front axle: 18mm

Rear axle: 18mm

5.7.3 The trailing arm axle bearing points in each Car must be left in the original position in which they were originally designed by Porsche (or the Porsche Group) for that Car. Additionally, the screw positions of the trailing arms at the wishbone bearing points in each Car may not be modified.

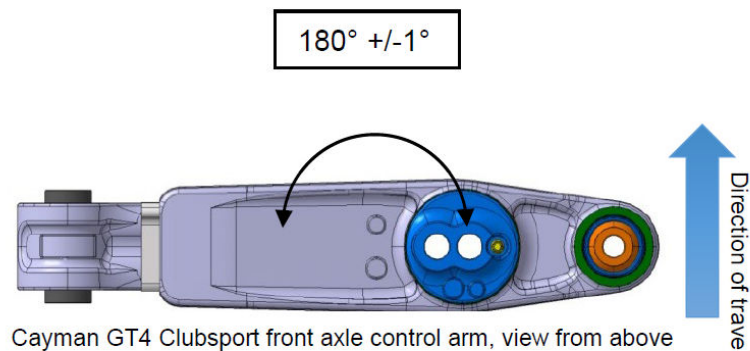

EXECUTION VERSION

- 5.7.4 No hub extensions are allowed in any Car.
- 5.7.5 The adjustment facility in length and height that is available as standard may be used in each Car.
- 5.7.6 The wheel base on the left and right side of each Car must be 2476mm +/- 10mm.
- 5.7.7 The anti-roll bars in each Car may be disconnected on the condition that no parts are removed.
- 5.7.8 The anti-roll bars on each Car can only be adjusted using the given range.
- 5.8 **Shock absorbers**
- 5.8.1 Only the factory installed shock absorbers and springs fitted in an unmodified condition in a Car can be used as follows:
- | | |
|-------------------------------|-------------|
| Front shock absorber: | 9F2412019 |
| Front main spring: | 9F2411105 |
| Front helper spring 75/60/43: | 9813435378A |
| Rear shock absorber: | 9F2512019 |
| Rear main spring: | 9F2511121 |
| Rear helper spring: | 9813435378A |
- 5.9 **Engine**
- 5.9.1 The seals on the engine on a Car must be as originally designed by Porsche (or the Porsche Group). Only Porsche (or the Porsche Group) sealed engines are allowed.
- 5.9.2 Only Porsche (or the Porsche Group) may carry out any rebuild or service work on an engine in a Car that requires a seal to be broken.
- 5.10 **Gearbox**
- 5.10.1 The differential housings provided by Porsche when each Car was originally built must be fitted to that Car and remain in the standard configuration as it was built by Porsche (or the Porsche Group) (shown below). The number of friction plates and assembly order must be as shown in Section 5.10.2 of this Part A below. The preload may be adjusted using pressure plates 991.332.983.8 Range A to M.
- 5.10.2 The ramp angle of the differential lock in each Car must be 50° drive and 35° coast. The ramp angles are determined from the axis of rotation.
- 5.10.3 Any modifications to the gearbox casings and to the internal casing surfaces, gears or gear surfaces and materials or any of the internal parts are strictly forbidden in any Car. The gearbox of each Car must remain as it was originally designed by Porsche (or the Porsche Group).
- 5.10.4 The only gear ratios allowed in a Car are as follows (and any changes to the following are not permitted):

| Gear | i_{gear} | $i_{tot.}$ |
|----------------------------|------------|------------|
| 1 | 43/11 | 3.909 |
| 2 | 55/24 | 2.292 |
| 3 | 43/26 | 1.654 |
| 4 | 43/33 | 1.303 |
| 5 | 40/37 | 1.081 |
| 6 | 37/42 | 0.881 |
| R | 39/11 | 3.545 |
| Constant | 47/41 | 1.146 |
| Ring gear and pinion shaft | 39/12 | 3.250 |

5.11 Lubricant and coolant

- 5.11.1 The only engine oil to be used in a Car is Mobil 1 0W-40 engine oil and no additives are permitted.
- 5.11.2 The only engine coolant to be used in a Car is Porsche Motorsport Coolant Glysantin G40-91 EF and no additives are permitted.
- 5.11.3 The only gearbox clutch oil to be used in a Car is Pentosin FFI 3 (Part No: 00004330513) and no additives are permitted.

5.12 Wheels

- 5.12.1 The wheels must remain as supplied with the Car by Porsche (or the Porsche Group). They may be painted or powder-coated however this must not affect the fitting of the wheel or tyre.
- 5.12.2 Any modification to the tyre bead friction strips is not permitted.
- 5.12.3 Wheels must be fitted with operational tyre pressure and temperature sensors as supplied by Porsche (or the Porsche Group).
- 5.12.4 Only metal valve caps supplied by Michelin, Protyre or Porsche may be fitted. Metal valve caps will be supplied by Michelin, Protyre or Porsche and must be fitted at all times during the Season.

5.13 Tyres

- 5.13.1 Only tyres manufactured by Michelin and distributed by Protyre may be used on a Car. Michelin's Technical Information for all F/R tyres can be found in their "preconisation" documents, set out below, and must be followed at all Events (with the only exception being Events at Thruxton, where the camber settings set out at Section 5.7.2 of this Part A shall apply and take precedent over the camber settings in the "preconisation" documents below). These documents include reference to start pressure and camber. For the avoidance of doubt, 'mini cold pressure' as stated in the documents is the start pressure. Start pressure is defined as the pressure in the tyre when the temperature in the tyre is at ambient temperature. The Tyre Pressure Management System values in the Car's data files will be used to determine the ambient temperature at all times, including while the Car is located in the team's awning, the paddock, and the assembly area. For the avoidance of doubt, it is not permitted to raise the temperature of the tyres and/or wheels above the natural ambient temperature by any means (see Section 5.13.5 of this Part A, below).

| 25/64 - 18 Slick Porsche cup N1 - N2 | |
|---|--|
| Usage | Circuit sans banking / Track without banking |
| Charge max / Max Load (static + dynamic) | 400 DaN |
| Vitesse max / Max speed | 280 Km/h |
| Jante nominale / Nominal Rim | 9.5 (+/-0,5) J 18 |
| Pression minimum à froid / Mini cold pressure | 1.5 Bar |
| Relais / Stints | 180 Km |

| Nb de relais / Nb stints | Pression minimum à chaud / Mini hot pressure | | | | | |
|--------------------------|--|---------|---------|---------|---------|---------|
| | 1.6 Bar | 1.7 Bar | 1.8 Bar | 1.9 Bar | 2.0 Bar | 2.1 Bar |
| Carrossage / Camber | | | | | | |
| -4.5 ° | 0 | 0 | 1 | 1 | 1 | 1 |
| -4.25 ° | 0 | 0 | 1 | 1 | 1 | 1 |
| -4.0 ° | 0 | 1 | 1 | 1 | 1 | 1 |
| From -2.0° to -3.75 ° | 0 | 1 | 1 | 1 | 1 | 1 |

| 27/68-18 | | | | | | |
|---------------------------------|-----------------------------|---------------------|---------------------|---------------------|---------------------|---------------------|
| NEW | | | | | | |
| MICHELIN Porsche Cup N2R | | | | | | |
| Usage | Track without banking | | | | | |
| Max speed | 320 km/h | | | | | |
| Nominal rim | 11 (-1 / +0.5) J 18 | | | | | |
| Minimum cold pressure | 16.0 Psi / 1.1 bar | | | | | |
| Stint length | 200 km | | | | | |
| Number of stints | Minimum hot pressure | | | | | |
| Camber | 26.1 Psi 1.8 bar | 27.6 Psi 1.9 bar | 29.0 Psi 2.0 bar | 30.5 Psi 2.1 bar | 31.9 Psi 2.2 bar | 33.4 Psi 2.3 bar |
| More negative than -4.0° | 0 | 0 | 0 | 0 | 0 | 0 |
| -3.51° to -4.0° | 0 | 2 | 2 | 2 | 2 | 2 |
| -3.01° to -3.5° | 0 | 2 | 2 | 2 | 2 | 2 |
| From -2° to -3.0° | 0 | 2 | 2 | 2 | 2 | 2 |

| 25/64 - 18 Rain P2L | |
|--|---|
| Usage | Circuit sans banking / Track without banking |
| Charge max / Max Load (static + dynamic) | 450 DaN |
| Vitesse max / Max speed | 320 Km/h |
| Jante nominale / Nominal Rim | 10 (+0,5/- 1) J 18 |
| Pression minimum à froid / Mini cold pressure | 1.3 Bar |
| Relais / Stints | 150 Km |

| Nb de relais / Nb stints | Pression minimum à chaud / Mini hot pressure | | | | | |
|---------------------------------|---|----------------|----------------|----------------|----------------|----------------|
| Carrossage / Camber | 1.7 Bar | 1.8 Bar | 1.9 Bar | 2.0 Bar | 2.1 Bar | 2.2 Bar |
| -4.25 ° | 0 | 0 | 0 | 1 | 2 | 2 |
| -4.0 ° | 0 | 0 | 1 | 2 | 2 | 2 |
| -3.75 ° | 0 | 0 | 1 | 2 | 2 | 2 |
| From -2.0° to -3.5 ° | 0 | 1 | 1 | 2 | 2 | 2 |

| 27/68 - 18 Rain P2G – P2L | |
|--|---|
| Usage | Circuit sans banking / Track without banking |
| Charge max / Max Load (static + dynamic) | 500 DaN |
| Vitesse max / Max speed | 280 Km/h |
| Jante nominale / Nominal Rim | 11 (+/- 0,5) J 18 |
| Pression minimum à froid / Mini cold pressure | 1.3 Bar |
| Relais / Stints | 250 Km |

| Nb de relais / Nb stints | Pression minimum à chaud / Mini hot pressure | | | | | |
|---------------------------------|---|----------------|----------------|----------------|----------------|----------------|
| Carrossage / Camber | 1.7 Bar | 1.8 Bar | 1.9 Bar | 2.0 Bar | 2.1 Bar | 2.2 Bar |
| -3.5 ° | 0 | 0 | 0 | 0 | 1 | 1 |
| -3.25 ° | 0 | 0 | 0 | 1 | 1 | 1 |
| -3.0 ° | 0 | 0 | 1 | 1 | 1 | 1 |
| From -2.0° to -2.75 ° | 0 | 1 | 1 | 1 | 1 | 1 |

- 5.13.2 Only atmospheric air is to be used as a filling medium for the tyres on a Car.
- 5.13.3 The removal of rubber pickup and stones is permitted for the tyres.
- 5.13.4 Any chemical or mechanical treatment of the tyres on a Car is not permitted.
- 5.13.5 The use of heated covers, tyre tents, exhaust gases or any other means to change the temperature of tyres prior to, during or after Events, is prohibited.
- 5.14 **Tyre allocation**
- 5.14.1 The maximum amount of new slick tyres that a Driver can declare and use throughout the Season at Friday Free Practices and Meetings is 74.

EXECUTION VERSION

5.14.2 If a Driver changes Entrants during the Season then they will transfer their tyre allocation to the new Entrant.

5.14.3 The quantity of wet tyres is unlimited.

5.14.4 There is no restriction on the quantity of tyres that a Driver may use on Porsche Test Days and Other Test Days.

5.15 **Declaration of tyres**

5.15.1 For all Meetings a maximum of eight new slick tyres can be declared for each Car per Meeting. In addition, two Previously Declared Tyres may be declared for each car per Meeting, save for the first Meeting taking place at Snetterton (Rounds 1 and 2 and 3) where two additional new slick tyres may be declared.

5.15.2 For all Friday Free Practices a maximum of eight slick tyres can be declared, of which a maximum of four can be new slick tyres for each Friday Free Practice.

5.15.3 The quantity and serial numbers of tyres must be declared by each Entrant to the Technical Team and Scrutineers using the Tyre Declaration letterbox located at the Porsche technical area. Tyres for: (i) Qualifying Sessions and Rounds must be declared no later than two hours prior to the start of that Qualifying Session; and (ii) Friday Free Practices must be declared no later than two hours prior to the start of that Friday Free Practice. Once submitted the quantity and serial numbers of the declared tyres are final and new tyres will be deducted from that Driver's allocation.

5.15.4 All tyres must be clearly marked with the relevant Car's competition number on the side wall and be visible when stored on a tyre trolley.

5.15.5 Only declared tyres can be in the Pit Lane during any Meeting or Friday Free Practice.

5.16 **Replacement of damaged tyres**

5.16.1 If a Driver damages a tyre during a Meeting and/or a Friday Free Practice, then that Driver may, without penalty, replace such damaged tyre with a Previously Declared Tyre from their allocation providing it was declared prior to that Meeting or Friday Free Practice (as applicable).

5.16.2 If a Driver damages a tyre during that Meeting or Friday Free Practice (as applicable) and wishes to replace such damaged tyre with a tyre that has not been declared prior to that Meeting or Friday Free Practice (as applicable):

(A) that Driver must obtain the prior approval of the Technical Team;

(B) that Driver must declare such replacement tyre(s) to the Technical Team no later than two hours after the end of the relevant Qualifying Session, Round or Friday Free Practice; and

(C) that Driver will start from the back of the grid for the next Round.

5.17 **Control of Fuel**

5.17.1 The only fuel to be used in a Car is Carless Hiperflo R20 as supplied by Vital Equipment in accordance with the Motorsport UK Regulations and no additives are permitted.

5.17.2 Refuelling of a Car during each Event is forbidden. Where refuelling or defueling a Car during a Meeting is permitted, the Entrant must ensure that, in addition to the individual that is refuelling or defueling the Car, there must be a second individual present with a fire extinguisher during the refuelling or defueling process who is adequately trained in the use of the fire extinguisher.

5.17.3 Should a team wish to refuel the Car using a closed loop refuelling system, the Car must be fitted with the refuelling plate with Part Number MT001235A as supplied by Manthey Racing or Porsche Motorsport. All other refuelling plates are prohibited.

5.17.4 The Scrutineers are authorised to take fuel samples from a Car at any time during an Event. The only method for removing fuel from the Car for scrutineering is via the de-fuelling coupling in the luggage compartment, shown below at item 2. Any removal of fuel may only be completed using the cars on-board fuel pumps. For the avoidance of doubt, no external pumps are to be used and no part of the fuel system is to be disassembled.

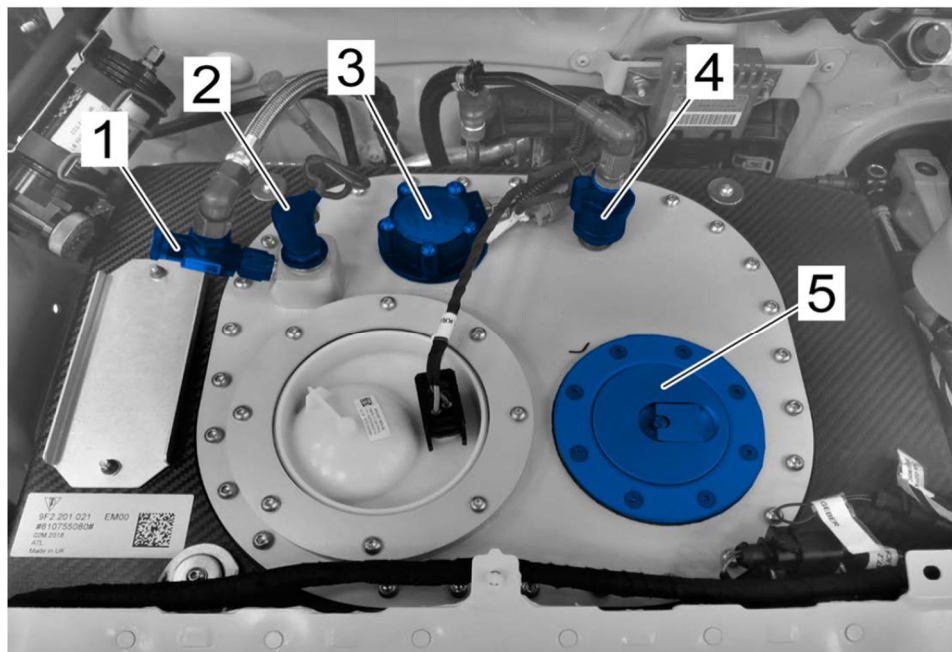

- 5.17.5 A Car must have a minimum of three litres of fuel in the tank for sampling before, during and after each Event.
- 5.17.6 The temperature of the fuel in a Car will be taken at the fuel tank. At no time is the temperature of the fuel to be lower than the lowest recorded outdoor air temperature in the last 24 hours (this will be available from the Technical Team).
- 5.18 **Noise test**
- 5.18.1 Noise limits will be measured in accordance with Motorsport UK Regulation J5.18.
- 5.18.2 The maximum permitted level for this method of measurement will be 93dB(A) at 2.0m / 105dB(A) at 0.5m with the engine at 75% maximum rpm.
- 5.19 **Radio**
- 5.19.1 The use of any kind of radio-based information transmission in a Car is prohibited.
- 5.20 **ECU**
- 5.20.1 The engine electronic control unit must be sealed by Porsche (or Porsche Group) for each Meeting and Friday Free Practice for that Meeting. The Technical Team reserves the right to re-program the electronic control unit at any time during those Events.
- 5.20.2 The Technical Team and the Scrutineers may check or exchange the electronic control unit or record engine data at any time during each Meeting and Friday Free Practice for that Meeting.
- 5.21 **Data**
- 5.21.1 Use of the Data System in each Car is mandatory. The Data System is assigned to the chassis number of each Car and must not be exchanged.
- 5.21.2 All recorded data from the Data System relating to Events must be made available to the Technical Team and the Scrutineers. No such data may be deleted by an Entrant or Driver prior to such data being provided to Porsche.
- 5.21.3 Any additional electrical connection to a Car's wiring harness is forbidden and the use of any other electronic device (including any mobile phone or tablet device) within a Car is forbidden.
- 5.21.4 No Entrant or Driver may use any computer and/or test equipment in the Pit Lane during any Qualifying Session or Round, other than an Entrant may use computers and/or test equipment for the sole purposes of recording lap times,

EXECUTION VERSION

setting up each Car and to ascertain climatic conditions. For the avoidance of doubt, no Entrant or Driver shall connect a computer and/or test equipment to a Car at any time whilst in the Pit Lane.

5.21.5 The Technical Team reserves the right to re-program the electronic control units and to reseal the plug-in connector at any time during each Event.

5.21.6 Porsche may share Driver and/or Entrant data with the Porsche Group to help diagnose faults and improve the reliability of its race cars.

5.22 Cameras

5.22.1 Each Driver must have their Car fitted with the following cameras (the “**Cameras**” and each a “**Camera**”):

- (A) if requested by the Broadcaster, the camera of the Broadcaster (the “**Broadcaster Camera**”); and
- (B) a Video Data Logger.

5.22.2 Save for the Cameras or otherwise with the prior written consent of the Championship Coordinator, no camera may be fitted in a Car.

5.22.3 Once fitted into a Car, the Cameras must not be tampered with. The Video Data Logger remains the property of RaceLogic and the Broadcaster Camera remains the property of the Broadcaster. On receipt of the Video Data Logger, each Entrant must follow the process specified by Porsche to verify its condition. Each Driver shall promptly return any Video Data Logger in their possession when requested by Porsche. Without prejudice to the generality of the foregoing, each Driver must return the Video Data Logger to Porsche by no later than fourteen days after the last Round of the Championship and any Driver that fails to return the Video Data Logger by such date will pay to Porsche a sum equal to £100 for each day that the Video Data Logger is not returned. Each Driver agrees to indemnify Porsche and keep Porsche indemnified at all times against all or any costs, claims, damages or expenses incurred by Porsche with respect to any loss of, damage to, or destruction of, any Video Data Logger that is in that Driver’s possession. Without prejudice to the generality of the foregoing, if any Driver fails to return the Video Data Logger to Porsche when required in accordance with this Section 5.22.3 of this Part A, or such Video Data Logger is returned not in working order, then such Driver shall be liable to, and promptly on demand pay, Porsche for the full replacement value of that Video Data Logger.

5.22.4 Each Driver is liable to pay Porsche or the Broadcaster (as appropriate) for any costs incurred in relation to any repair required as a result of any damage to a Camera caused whilst that Camera is installed in that Driver’s Car (including, if the Camera cannot be replaced, the cost to replace such Camera).

5.22.5 The Driver must ensure that each Camera is switched on prior to the time of the two-minute Round start signal. Any Driver that fails to comply with the foregoing is liable to a fine of £1,000 per Camera for each offence.

5.22.6 The copyright in any visual, audio or audio-visual footage produced via the Broadcaster Camera is owned by the Broadcaster. No Driver or Entrant may use any such footage save as set out in Section 6.11.

5.22.7 Porsche shall provide to each Driver, and each Driver shall use, an SD memory card for use in the Video Data Logger during each Qualification Session and Round. Porsche may provide training on how to use the Video Data Logger.

5.22.8 The copyright in any data, visual, audio or audio-visual footage produced via the Video Data Logger (the “**VDL Materials**”) is owned by Porsche. No Driver or Entrant may use any such footage save as set out in Sections 6.10 and 5.22.9 of this Part A.

5.22.9 Porsche licences Drivers and Entrants to download, retain and use the VDL Materials on a revocable, limited basis as follows:

- (A) Subject to Section 5.22.9(B) of this Part A, each Driver and Entrant is permitted to download the VDL Materials in relation to a Meeting only after the end of the Qualifying Session on the Saturday of that Meeting and following the conclusion of any judicial procedure, and within a set time period to be notified by Porsche.
- (B) At any Meeting, Porsche may (in its sole discretion) permit Drivers and Entrants to download the VDL Material earlier than the time set out at Section 5.22.9(A) of this Part A. If Porsche so determines, the relevant time and any other conditions will be notified in a Bulletin.
- (C) The Driver or Entrant is responsible for downloading the VDL Materials onto their own device.

EXECUTION VERSION

- (D) When downloading the VDL Materials onto their own device, the Driver or Entrant must not delete the VDL Materials from the Video Data Logger.
- (E) The VDL Materials must not be published or shared with anyone other than the Driver or Entrant until 9.00 am (UK time) on the second Monday after the end of the Meeting.
- (F) After 9.00 am (UK time) on the second Monday after the end of the Meeting, the Driver or Entrant may use and/or publish the footage but only for promotional purposes.
- (G) Drivers and Entrants must use the VDL Materials at all times in the best interests of the Championship. Any improper behaviour relating to the VDL Materials, such as (without limitation) corrupting, tampering with or deleting the information stored on the SD card, or using the VDL Materials in relation to any discussion of a racing incident in a public forum, will be grounds for Porsche to revoke the licence set out in this Section 5.22.9 of this Part A, and, in addition, any Driver or Entrant that deletes, corrupts or tampers with the VDL Materials stored on the Video Data Logger will incur a fine of £1,000 for each offence.
- (H) At the end of the Season, or if the trial is ended prematurely, any Driver who or Entrant that has already downloaded any VDL Materials may retain those VDL Materials, subject to compliance with this Section 5.22.9 of this Part A.

The licence granted by Porsche in this Section 5.22.9 of this Part A may be revoked by Porsche at any time in its discretion with immediate effect, either for particular Drivers and/or Entrants or for all Drivers and/or Entrants.

5.23 **Bodywork**

- 5.23.1 The bodywork of each Car must remain in the condition it was in when the Car was originally built by Porsche (or the Porsche Group).
- 5.23.2 Adding tape to any join or edge on the bodywork or the underside of a Car is prohibited. Taping the original fuel filler flap on the wing of a Car is permitted.
- 5.23.3 The roof shall be fitted with a KED system to assist with removal of the Driver in the event of an accident. The hatch measures 565mm x 475mm and is retained by seven livelock fixings. The livelocks must be accessible at all times and must not be painted or covered.

5.24 **Windscreen, windows and ventilation**

- 5.24.1 To protect a Car's windscreen, tear-off screens may be fitted to that Car's windscreen. The fitting must be controlled and approved by the Scrutineers and must be removed on the request of the Scrutineers. Only windscreens with the following part number may be used:

982845011AJ

- 5.24.2 Only the genuine side and rear windows (in accordance with Appendix J to the International Sporting Code) of a Car are to be used as supplied by Porsche.

5.25 **Rear wing**

- 5.25.1 The position of the wing of each Car may only be changed within the specified range of the rear wing pylons. All parts must be unmodified and as supplied with the Porsche 718 Cayman GT4 Clubsport.

5.26 **Additional requirements**

- 5.26.1 The seals or markings applied to a Car must not be damaged, altered or copied. All modifications to a Car that are authorised by the Technical Regulations must serve the intended purpose only.
- 5.26.2 Porsche reserves the right to impound and seal any Car or any of its associated parts at the end of any Event and send such Car or parts (as appropriate) to the Porsche Motorsport Technical workshop for further Scrutineering and the relevant Driver has the right to be present during such Scrutineering (but failure to attend will be deemed to mean that the Driver agrees with the findings should the Scrutineering find any non-compliance with the Technical Regulations). The collection of the Car or parts (as appropriate) after such Scrutineering will be the responsibility of, and at the cost of, the relevant Driver.

EXECUTION VERSION

5.26.3 Any Entrant running two or more Cars in the Championship must own and have available at each Event a Deutronic DBL Charging Computer and cable (Deutronic DBL Charging Computer part no.: ASE4470390000. Cable part no.: ASE62200700020).

5.27 **Virtual Flag System**

5.27.1 All Entrants, prior to the Championship Launch Day, must:

- (A) purchase a loom and antenna kit from Porsche; and
- (B) install the racelink receiver (the “**Racelink Receiver**”) that the Entrant has received from Porsche, (together, the “**Virtual Flag Equipment**”).

5.27.2 All Entrants must install the Virtual Flag Equipment, in accordance with the instructions provided, in the Cars by the Championship Launch Day (or, for any Driver that registers for the Championship after the Championship Launch Day, prior to the first Meeting in which that Driver participates) and the Virtual Flag Equipment must remain installed for the Season.

5.27.3 The Virtual Flag Equipment will allow each Driver to use the virtual flag system (the “**Virtual Flag System**”) during Meetings. The Virtual Flag System will notify Drivers of any flags at the Track through sending digital messages to the Car dashboard. Notwithstanding the foregoing, the Virtual Flag System is a supplementary aid to Drivers only which in no way overrides or replaces the on-Track flags. In the event of any discrepancy between the flags displayed on-Track and the flags displayed under the Virtual Flag System, the on-Track flags shall prevail. Drivers are not permitted to rely on the Virtual Flag System at any time and Porsche, the Organising Club, TOCA and/or Timing Solutions Limited (as the entity from which Porsche hires the Racelink Receiver) shall be in no way liable for any malfunction of the Virtual Flag Equipment.

5.27.4 The Racelink Receiver, as between Porsche and the Entrants/Drivers, remains the property of Porsche and each Entrant will be required to return it (including all components of the Racelink Receiver) to Porsche on or before the date so determined by Porsche at Porsche’s sole discretion. In the event that an Entrant fails to return the Virtual Flag Equipment or any component in accordance with this Section 5.27.4 of this Part A, or the Virtual Flag Equipment or any component is returned not in working order, that Entrant will be liable to, and promptly on demand pay, Porsche for the cost of that Virtual Flag Equipment or component (as applicable).

5.28 **Safety Self-Declaration Form**

5.28.1 Each Entrant is required to complete the Safety Self-Declaration Form set out in Appendix 11 and return it to the Scrutineers by the date so notified to the Entrants by the Championship Coordinator. The Safety Self-Declaration Form must be completed by an individual who is suitably qualified to inspect the Car.

5.29 **Seal**

5.29.1 The following seals must be affixed to the Car:

Engine:

- Valve cover, left (1x)
- Valve cover, right (1x)
- Oilsump (1x)

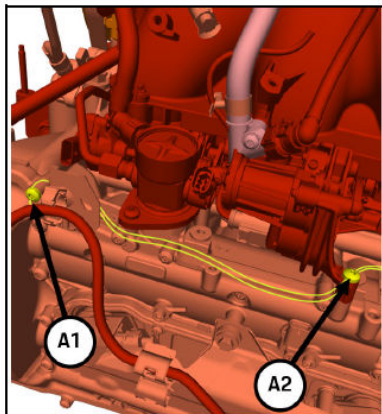
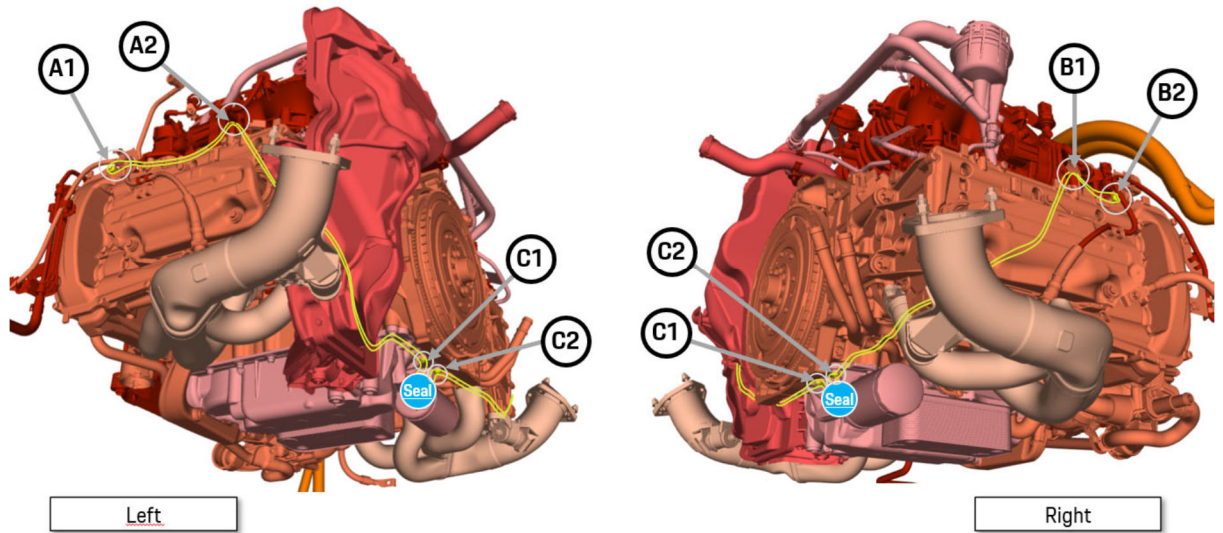

LOCKWIRE BOLT POS A1 & A2

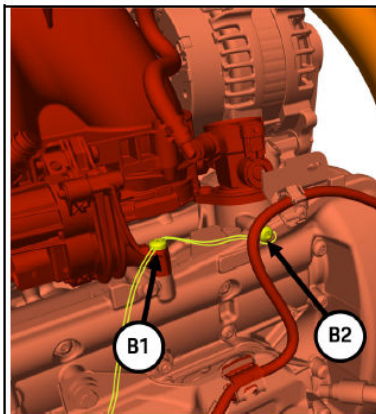

LOCKWIRE BOLT POS B1 & B2

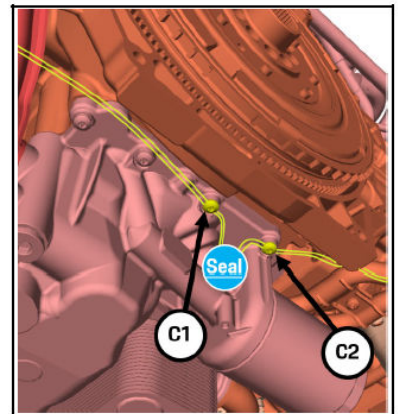

LOCKWIRE BOLT POS C1 & C2

5.29.2 If seals and marks are applied to the Car by the Technical Scrutineers or Dr. Ing. H.c. F. Porsche AG, these must not be damaged, changed or reproduced. If one or more damaged or missing seals or markings are discovered, the Car can be excluded from all Events until they are replaced.

PART B – PORSCHE 718 CAYMAN GT4 RS CLUBSPORT**5.1 Introduction**

- 5.1.1 The Technical Regulations are set out in accordance with Motorsport UK's specified format. The Technical Regulations apply in addition to Motorsport UK Regulations J, K (as applicable to the Championship) and Q with which shall each Driver and Entrant shall comply.
- 5.1.2 Save for Sections that are expressly stated to apply in a narrower or wider context, each Entrant must procure that its Drivers, and each Driver shall, only drive Cars in Meetings that comply with Section 1.9 and this Part B of Section 5. No Entrant may make any modifications to a Car save as expressly set out in this Part B of Section 5 or otherwise expressly agreed in advance by the Championship Coordinator.
- 5.1.3 Each Car must comply with the description set out in Appendix 5.
- 5.1.4 All part numbers set out in this Part B of Section 5 are subject to change at Porsche's sole discretion from time to time.
- 5.1.5 The chassis of each Car must be registered on the Porsche Motorsport Racecar Service Information (PMRSI) prior to the Championship Launch Day. As a result of registering on the PMRSI, Porsche may send bulletins from time to time which require confirmation of an action relating to a Car. All steps required to be taken by the PMRSI must be carried out prior to each Event. The Scrutineer may, at its sole discretion, issue a technical non-compliance and prevent a Car from being used at an Event in the event that the action required via the PMRSI has not been taken prior to the Event.

5.2 Safety requirements

- 5.2.1 The design and fixation of the roll cage of a Car must remain unmodified from the original version of that Car. The Entrant must provide a copy of the roll cage certificate to the Scrutineers prior to the first Meeting.
- 5.2.2 The service interval of the fuel cell (FT3 safety fuel cell) of a Car must be maintained. The Entrant must provide a copy of the documents supplied to the Scrutineers prior to the first Meeting.
- 5.2.3 Fire extinguisher – a standard fire extinguisher system, which meets the provisions set out in Motorsport UK Regulation K3.1, plumbed-in for discharge into both cockpit and engine compartment, must be fitted to each Car. The fire extinguisher fitted must be of the type and specification as originally supplied with the Car.
- 5.2.4 Towing eyes – the towing eyes supplied when a Car was originally built by Porsche (or the Porsche Group) must be properly mounted and clearly marked in that Car in accordance with Motorsport UK Regulations Q13.1.3.
- 5.2.5 Drivers must wear the following items:
- (A) clean flame-resistant overalls in accordance with FIA Standard 8856 – 2000 or FIA Standard 8856 – 2018;
 - (B) clean flame-resistant underwear (with long arms and legs) in accordance with FIA Standard 8856 – 2000 or FIA Standard 8856 – 2018;
 - (C) clean flame-resistant balaclava in accordance with FIA Standard 8856 – 2000 or FIA Standard 8856 – 2018;
 - (D) clean flame-resistant socks and shoes in accordance with FIA Standard 8856 – 2000 or FIA Standard 8856 – 2018;
 - (E) clean flame-resistant gloves in accordance with FIA Standard 8856 – 2000 or FIA Standard 8856 – 2018; and
 - (F) a helmet including HANS clips in accordance with FIA Regulations (Appendix L to the International Sporting Code).
- 5.2.6 Drivers must fasten and secure a six-point SCHROTH seat belt with FIA homologation in accordance with FIA-standard 8853 – 2016 and Motorsport UK Regulation K2.1.7.
- 5.2.7 Frontal head restraint system ("FHR"): the use of an FIA approved FHR (HANS or other comparable device) in accordance with FIA list no. 29 is compulsory in each Car. The certificate of the manufacturer of the FHR must be presented during Eligibility Scrutineering.

EXECUTION VERSION

5.2.8 Each Car must be fitted with Safety Nets and fitted in accordance with Porsche (or Porsche Group) instructions. The following parts are to be fitted:

- (A) AS Safety Net Side 9917225217A;
- (B) Threaded Pin GT3R 19 Net 9F0857973;
- (C) AS Safety Net Center 9917225237A;
- (D) Bent Attachment Safety Cage 9917225137C;
- (E) Pan-Head Screw M6X20 N10653601;

5.2.9 The seat in each Car must be a standard Recaro seat with FIA homologation in accordance with FIA standard 8862-2009. Adjustments of any such seat by removing or adding padding material are only permitted by utilising the following systems:

- (A) Corbeau Pro-Seat BN 3795 covered in black nylon with accompanying certificate of conformance (or padding sourced from an alternative supplier as long it conforms to the flammability standards of FIA standard 8862-2009, and is the same colour and made of the same material as the original equipment);
- (B) the removal of the entire padding system in the seat is not permitted. A minimum padding thickness of 10mm must be maintained as must the original upholstery and the requirements of the below diagram must be complied with. The seat structure and seat rails must remain unmodified. Padding must not obscure any branding on the seat. Padding must not be fitted higher than the shoulder wings on the standard fit seat; and

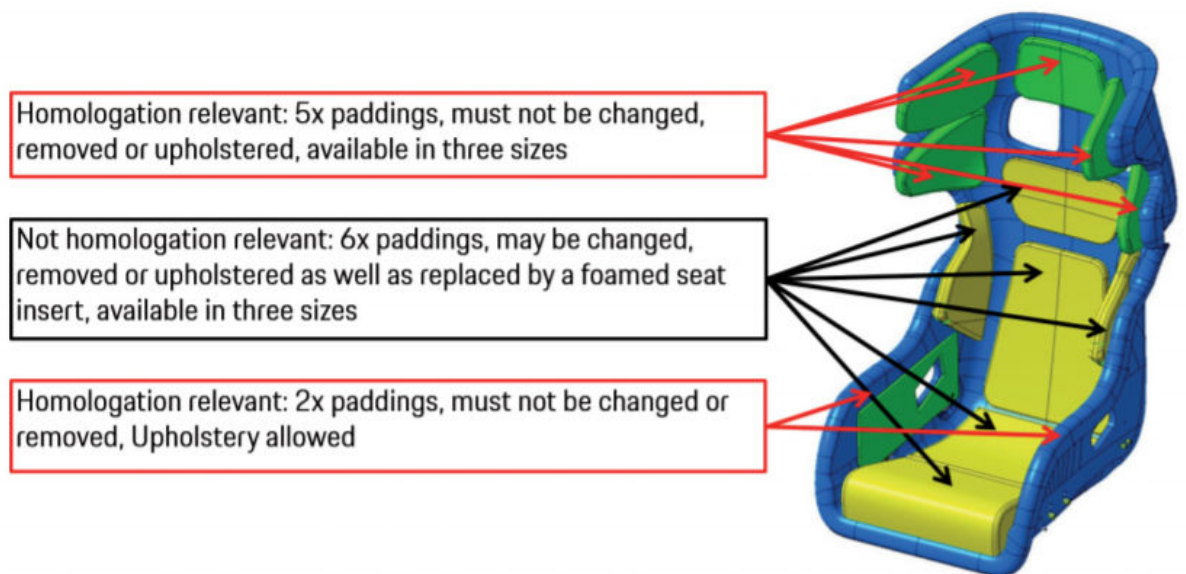

- (C) a drinking system without an electric pump may be used. Prior to use it must be approved by Eligibility Scrutineers.

5.2.10 A cool suit may be used by each Driver provided that it is approved in advance of use by the Eligibility Scrutineers.

5.2.11 Any biometric or physiological monitoring device worn by a Driver must comply with the safety regulations set out in these Regulations, the Motorsport UK Regulations and the FIA Regulations and be declared to the Eligibility Scrutineers, who in conjunction with the Medical Advisor, will make the final decision about its use. Any data recorded must be shared in full with Porsche and the Medical Advisor.

5.2.12 Championship fireproof badges must be attached to the Driver's Race Suits (as specified in Appendix 4). The Championship Coordinator will provide such fireproof badges to each Entrant. As an alternative, such badges may be embroidered into the Driver's Race Suit by the Race Suit manufacturer provided they are embroidered using fireproof material.

5.3 Permitted modifications and built-in components

EXECUTION VERSION

- 5.3.1 Subject to Section 5.3.2 of this Part B, modification to a Car that is part of the regular maintenance of that Car or that serves for the replacement of parts that have become defective as a result of wear or an accident is permitted.
- 5.3.2 Any modifications under Section 5.3.1 of this Part B are only permitted within the scope defined below:
- (A) parts damaged as a result of wear or accidents may only be replaced by genuine Porsche parts, which are dedicated to the Porsche 718 Cayman GT4 RS Clubsport;
 - (B) the use of any component manufactured by Porsche (or the Porsche Group) that is not a component that forms part of the Porsche 718 Cayman GT4 RS Clubsport as delivered by Porsche is prohibited;
 - (C) standard fasteners such as screws, nuts bolts, washers, circlips spring washers, split pins may only be replaced with genuine Porsche parts; and
 - (D) in case of threads, the thread type, size and pitch (e.g. M8 x 1.25) are to be retained.
- 5.3.3 The fitment of a mesh guard set for the air intakes on the Left and Right Hand Side of the Porsche 718 Cayman GT4 RS Clubsport is mandatory. Only Mesh Air Intake guards as supplied by Manthey Racing or Porsche Motorsport with the Part Numbers MTH541561 (LH) & MTH541562 (RH) are to be fitted. (figure 2) All other mesh and grille material is prohibited.

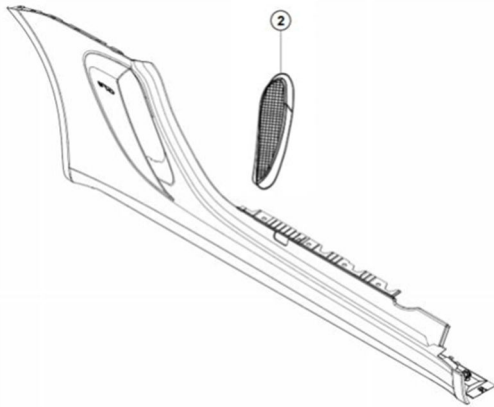

- 5.3.4 Every type of machining, additional fitting of seals, welding, strengthening, polishing, sanding, coating and every type of other possible change to an original part of a Car is forbidden.
- 5.3.5 Any technical information and safety guideline included in Bulletins must be strictly observed and obeyed.
- 5.3.6 No Car may have coloured headlight covers. Headlights can be protected with a suitable clear material which must: (i) be fitted on an unused headlight; and (ii) have no impact on the functionality of the headlights.

5.4 Weight

- 5.4.1 The combined weight of a Car and its Driver (including their personal equipment as it is worn in the Car whilst driven on track) must not be less than 1400 kg. For these purposes, liquids and oils are to be set within their operational levels and the Car is to be fitted with declared tyres.
- 5.4.2 The only method for removing fuel from the Car for scrutineering is as set out at Section 5.17 of this Part B.
- 5.4.3 The following are to be included when checking the combined weight of a Car:
- (A) the Video Data Logger; and
 - (B) the Broadcaster's Camera (if designated to the Driver).
- 5.4.4 When requested by any Championship official or Scrutineer, each Driver must present themselves and their Car to the official scale of the Championship (in a location to be notified by Porsche). If the weight of the Car and Driver (including their personal equipment as it is worn in the Car) is less than 1,400kg, then equalisation weight in the form of Porsche ballast plates must be fitted. Part numbers as per the latest parts manual on PMRSI.

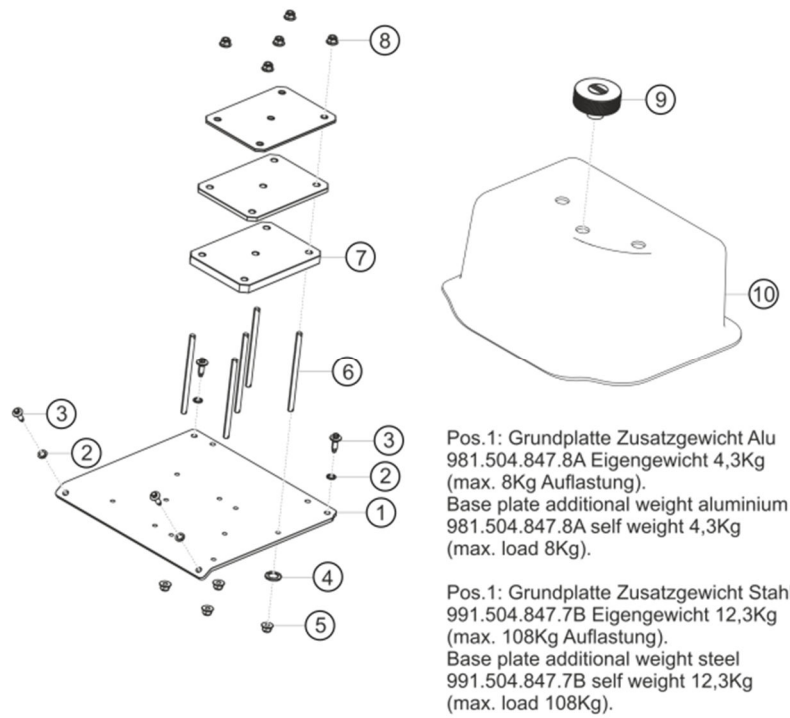

5.4.5 The official scales of the Championship will be in a location to be notified by Porsche. Alternative certified scales will be nominated by the Technical Team in the event of the official scales of the Championship not being available.

5.5 Ground clearance

5.5.1 Each Car must have a minimum ride height of 83 mm front and 100 mm rear. This is to be checked with the Driver including their or her personal equipment as it is worn in the Car whilst driven on a Track. Declared tyres are to be fitted and set to 2.0 bar (+/-0.1 bar). The points of measurement are as illustrated below for both the front and rear axle.

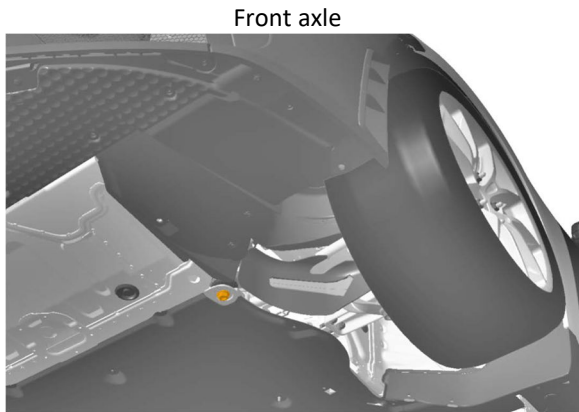

Height measurement (base), front axle

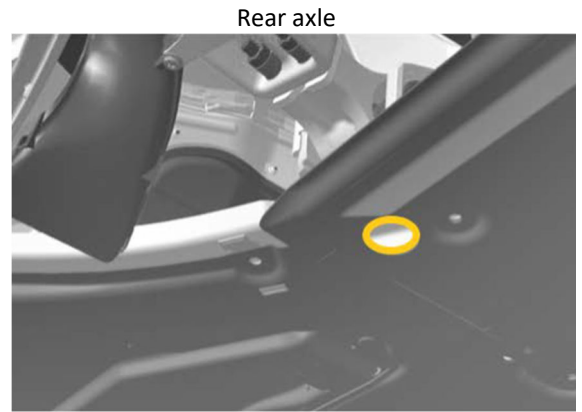

Height measurement (base), rear axle

5.5.2 Changing the ride height of a Car by altering the adjustment nuts on the suspension struts is not permitted during Qualifying Sessions and/or Rounds.

5.5.3 The official flat patch of Porsche will be located in an area to be nominated by Porsche.

5.6 Brakes

5.6.1 5B.6.1 Only the following brake callipers are permitted to be used on a Car:

LF: 9F2615123

RF: 9F2615124

LR: 9F2615423

EXECUTION VERSION

RR: 9F2615424

- 5.6.2 The following knock-back springs are to be fitted under each piston of all brake callipers on each Car. Modification of these springs is prohibited.

FRONT: 9913519638A

REAR: 9913529638A

- 5.6.3 Only the following front brake discs and pads are permitted on each Car:

LF: 9F2615283

RF: 9F2615284

RACING BRAKE PADS: 9913519428B

- 5.6.4 Only the following rear brake discs and pads are permitted on each Car:

LR: 9F2615583

RR: 9F2615584

RACING BRAKE PADS: 9F2615117A

- 5.6.5 Only the following brake master cylinders are permitted on each Car:

FRONT: 17.8 MM DIAMETER 9F1611011D

REAR: 17.8 MM DIAMETER 9F1611011D

- 5.6.6 Only performance friction racing brake fluid PFC Brake Fluid-325 ° (DOT4) is to be used in the brake and clutch hydraulic systems in each Car.

5.7 Steering

- 5.7.1 Suspension adjustments to a Car may only be made within the limits of the existing adjustment ranges of the Car. All genuine Porsche 718 Cayman GT4 RS Clubsport Car parts must be retained.

- 5.7.2 Unless otherwise notified via a Bulletin or in this Section 5.7.2 of this Part B, the maximum thickness of the spacer washers within the front and rear axle control arms in each Car are:

FRONT AXLE: 18MM

REAR AXLE: 18MM

- 5.7.3 The trailing arm axle bearing points in each Car must be left in the original position in which they were originally designed by Porsche (or the Porsche Group) for that Car. Additionally, the screw positions of the trailing arms at the wishbone bearing points in each Car may not be modified.

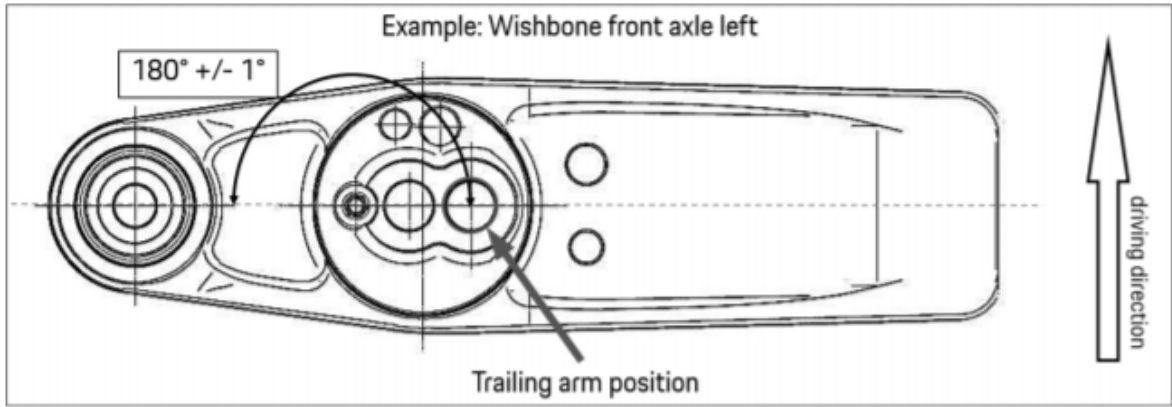

5.7.4 No hub extensions are allowed in any Car.

5.7.5 The adjustment facility in length and height that is available as standard may be used in each Car.

5.7.6 The wheel base on the left and right side of each Car must be 2476mm +/- 10mm.

5.7.7 The anti-roll bars in each Car may be disconnected on the condition that no parts are removed.

5.7.8 The anti-roll bars on each Car can only be adjusted using the given range.

5.8 Suspension

5.8.1 Only the factory -installed type KW shock absorbers and KW chassis springs in their original condition (as set out below) are permitted to be used on the Car. The original delivery condition of the bump stops must not be modified in any way.

SHOCK ABSORBERS

LF: 9F2412023B

RF: 9F2412024B

LR: 9F2512020B

RR: 9F2512020B

DAMPING IS FIXED. THE DAMPERS MUST BE SET AT THE FOLLOWING SETTINGS:

FRONT – BUMP/REBOUND: 5/5

REAR – BUMP/REBOUND: 10/5

SPRINGS

FRONT: 9F2411105B

REAR: 9F2511121B

HELPER

FRONT: 9813435378A

REAR: 9813435378A

5.8.2 The above settings must be adhered to at every Event. Any Car found to have different setting to those stated will be subject to a technical non-compliance and will be disqualified from that day's on-track sessions..

EXECUTION VERSION

5.8.3 For the avoidance of doubt, the measurements will be taken by adjusting the dampers to ‘full hard’, then winding back to the applicable number stated above.

5.9 Engine

5.9.1 The seals on the engine on a Car must be as originally designed by Porsche (or the Porsche Group). Only Porsche (or the Porsche Group) sealed engines are allowed.

5.9.2 Only Porsche (or the Porsche Group) may carry out any rebuild or service work on an engine in a Car that requires a seal to be broken.

5.10 Gearbox

5.10.1 The differential housings provided by Porsche when each Car was originally built must be fitted to that Car and remain in the standard configuration as it was built by Porsche (or the Porsche Group) (shown below). The number of friction plates and assembly order must be as shown in Section 5.10.2 of this Part B below. The preload may be adjusted using pressure plates 991.332.983.8 Range A to M.

5.10.2 The ramp angle of the differential lock in each Car must be 50° drive and 35° coast. The ramp angles are determined from the axis of rotation.

5.10.3 Any modifications to the gearbox casings and to the internal casing surfaces, gears or gear surfaces and materials or any of the internal parts are strictly forbidden in any Car. The gearbox of each Car must remain as it was originally designed by Porsche (or the Porsche Group).

5.10.4 The only gear ratios allowed in a Car are as follows (and any changes to the following are not permitted):

| Gear | i_{gear} | $i_{\text{tot.}}$ |
|----------------------------|-------------------|-------------------|
| 1 | 45/12 | 3.750 |
| 2 | 50/21 | 2.381 |
| 3 | 43/25 | 1.720 |
| 4 | 43/32 | 1.344 |
| 5 | 39/35 | 1.114 |
| 6 | 44/46 | 0.957 |
| 7 | 38/45 | 0.844 |
| R | 41/12 | 3.417 |
| Constant | 50/39 | 1.282 |
| Ring gear and pinion shaft | 39/12 | 3.250 |

Overall ratio = gear ratio x constant x ring gear and pinion shaft

5.11 Lubricant and coolant

5.11.1 The only engine oil to be used in a Car is Mobil 1 ESP X3 0W-40 engine oil and no additives are permitted.

5.11.2 The only engine coolant to be used in a Car is Porsche Motorsport Coolant Glysantin G40-91 EF and no additives are permitted.

5.11.3 The only gearbox clutch oil to be used in a Car is Pentosin FFI 3 (Part No: 00004330513/ 00004330514) and no additives are permitted.

5.12 Wheels

5.12.1 The wheels must remain as supplied with the Car by Porsche (or the Porsche Group). They may be painted or powder-coated however this must not affect the fitting of the wheel or tyre.

EXECUTION VERSION

- 5.12.2 Any modification to the tyre bead friction strips is not permitted.
- 5.12.3 Wheels must be fitted with operational tyre pressure and temperature sensors as supplied by Porsche (or the Porsche Group).
- 5.12.4 Only metal valve caps supplied by Michelin, Protyre or Porsche may be fitted. Valve Metal valve caps will be supplied by Michelin, Protyre or Porsche and must be fitted at all times during the Season.

5.13 Tyres

5.13.1 Only tyres manufactured by Michelin and distributed by Protyre may be used on a Car. Michelin’s Technical Information for all F/R tyres can be found in their “preconisation” documents, set out below, and must be followed at all Events (with the only exception being Events at Thuxton, where the camber settings set out at Section 5.7.2 of this Part B shall apply and take precedent over the camber settings in the “preconisation” documents below). These documents include reference to start pressure and camber. For the avoidance of doubt, ‘mini cold pressure’ as stated in the documents is the start pressure. Start pressure is defined as the pressure in the tyre when the temperature in the tyre is at ambient temperature. The Tyre Pressure Management System values in the Car’s data files will be used to determine the ambient temperature at all times, including while the Car is located in the team's awning, the paddock, and the assembly area. For the avoidance of doubt, it is not permitted to raise the temperature of the tyres and/or wheels above the natural ambient temperature by any means (see Section 5.13.5 of this Part B, below).

25/64-18

| MICHELIN Porsche Cup N2 | |
|---|--|
| Usage | Porsche Cayman GT4 RS CS (full power engine) Circuit sans banking / Track without banking |
| Charge maxi / Max load (static + dynamic) | 490 daN |
| Vitesse maxi / Max speed | 310 km/h / 193 mph |
| Jante nominale / Nominal rim | 9.5 (±0.5) J 18 |
| Pression mini à froid / Minimum cold pressure | 1.4 bar / 20.3 psi |
| Longueur du relais / Stint length | 200 km / 124 mi |

| Nombre de relais / Number of stints | Pression mini à chaud / Minimum hot pressure (bar / psi) | | | | | |
|-------------------------------------|--|------------|------------|------------|------------|------------|
| Carrossage / Camber | 1.6 / 23.2 | 1.7 / 24.7 | 1.8 / 26.1 | 1.9 / 27.6 | 2.0 / 29.0 | 2.1 / 30.5 |
| -4.51° | 0 | 0 | 0 | 0 | 0 | 0 |
| -4.01° to -4.5° | 0 | 0 | 0 | 1 | 2 | 2 |
| -3.51° to -4.0° | 0 | 0 | 0 | 1 | 2 | 2 |
| From -2.0° to -3.5° | 0 | 0 | 0 | 1 | 2 | 2 |

27/68-18

| MICHELIN Porsche Cup N2R | |
|---|--|
| Usage | Porsche Cayman GT4 RS CS (full power engine) Circuit sans banking / Track without banking |
| Charge maxi / Max load (static + dynamic) | 600 daN |
| Vitesse maxi / Max speed | 310 km/h / 193 mph |
| Jante nominale / Nominal rim | 11 (-1/+0.5) J 18 |
| Pression mini à froid / Minimum cold pressure | 1.2 bar / 17.4 psi |
| Longueur du relais / Stint length | 200 km / 124 mi |

| Nombre de relais / Number of stints | Pression mini à chaud / Minimum hot pressure (bar / psi) | | | | | |
|-------------------------------------|--|------------|------------|------------|------------|------------|
| Carrossage / Camber | 1.8 / 26.1 | 1.9 / 27.6 | 2.0 / 29.0 | 2.1 / 30.5 | 2.2 / 31.9 | 2.3 / 33.4 |
| -4.01° | 0 | 0 | 0 | 0 | 0 | 0 |
| -3.51° to -4.0° | 0 | 0 | 1 | 2 | 2 | 2 |
| -3.01° to -3.5° | 0 | 0 | 1 | 2 | 2 | 2 |
| From -2.0° to -3.0° | 0 | 0 | 1 | 2 | 2 | 2 |

| 25/64 - 18 Rain P2L | |
|---|--|
| Usage | Circuit sans banking / Track without banking |
| Charge max / Max Load (static + dynamic) | 450 DaN |
| Vitesse max / Max speed | 320 Km/h |
| Jante nominale / Nominal Rim | 10 (+0,5/- 1) J 18 |
| Pression minimum à froid / Mini cold pressure | 1.3 Bar |
| Relais / Stints | 150 Km |

| Nb de relais / Nb stints | Pression minimum à chaud / Mini hot pressure | | | | | |
|---------------------------------|---|---------|---------|---------|---------|---------|
| Carrossage / Camber | 1.7 Bar | 1.8 Bar | 1.9 Bar | 2.0 Bar | 2.1 Bar | 2.2 Bar |
| -4.25 ° | 0 | 0 | 0 | 1 | 2 | 2 |
| -4.0 ° | 0 | 0 | 1 | 2 | 2 | 2 |
| -3.75 ° | 0 | 0 | 1 | 2 | 2 | 2 |
| From -2.0° to -3.5 ° | 0 | 1 | 1 | 2 | 2 | 2 |

| 27/68 - 18 Rain P2G – P2L | |
|---|--|
| Usage | Circuit sans banking / Track without banking |
| Charge max / Max Load (static + dynamic) | 500 DaN |
| Vitesse max / Max speed | 280 Km/h |
| Jante nominale / Nominal Rim | 11 (+/- 0,5) J 18 |
| Pression minimum à froid / Mini cold pressure | 1.3 Bar |
| Relais / Stints | 250 Km |

| Nb de relais / Nb stints | Pression minimum à chaud / Mini hot pressure | | | | | |
|---------------------------------|---|---------|---------|---------|---------|---------|
| Carrossage / Camber | 1.7 Bar | 1.8 Bar | 1.9 Bar | 2.0 Bar | 2.1 Bar | 2.2 Bar |
| -3.5 ° | 0 | 0 | 0 | 0 | 1 | 1 |
| -3.25 ° | 0 | 0 | 0 | 1 | 1 | 1 |
| -3.0 ° | 0 | 0 | 1 | 1 | 1 | 1 |
| From -2.0° to -2.75 ° | 0 | 1 | 1 | 1 | 1 | 1 |

- 5.13.2 Only atmospheric air is to be used as a filling medium for the tyres on a Car.
- 5.13.3 The removal of rubber pickup and stones is permitted for the tyres.
- 5.13.4 Any chemical or mechanical treatment of the tyres on a Car is not permitted.
- 5.13.5 The use of heated covers, tyre tents, exhaust gases or any other means to change the temperature of tyres prior to, during or after Events, is prohibited.

5.14 Tyre allocation

- 5.14.1 The maximum amount of new slick tyres that a Driver can declare and use throughout the Season at Friday Free Practices and Meetings is 74.
- 5.14.2 If a Driver changes Entrants during the Season then they will transfer their tyre allocation to the new Entrant.
- 5.14.3 The quantity of wet tyres is unlimited.
- 5.14.4 There is no restriction on the quantity of tyres that a Driver may use on Porsche Test Days and Other Test Days.

5.15 Declaration of tyres

- 5.15.1 For all Meetings a maximum of eight new slick tyres can be declared for each Car per Meeting. In addition, two Previously Declared Tyres may be declared for each car per Meeting, save for the first Meeting taking place at Snetterton (Rounds 1 and 2 and 3) where two additional new slick tyres may be declared.
- 5.15.2 For all Friday Free Practices a maximum of eight slick tyres can be declared, of which a maximum of four can be new slick tyres for each Friday Free Practice
- 5.15.3 The quantity and serial numbers of tyres must be declared by each Entrant to the Technical Team and Scrutineers using the Tyre Declaration letterbox located at the Porsche technical area. Tyres for: (i) Qualifying Sessions and Rounds must be declared no later than two hours prior to the start of that Qualifying Session; and (ii) Friday Free Practices must be

EXECUTION VERSION

declared no later than two hours prior to the start of that Friday Free Practice. Once submitted the quantity and serial numbers of the declared tyres are final and new tyres will be deducted from that Driver's allocation.

5.15.4 All tyres must be clearly marked with the relevant Car's competition number on the side wall and be visible when stored on a tyre trolley.

5.15.5 Only declared tyres can be in the Pit Lane during any Meeting or Friday Free Practice.

5.16 Replacement of damaged tyres

5.16.1 If a Driver damages a tyre during a Meeting and/or a Friday Free Practice, then that Driver may, without penalty, replace such damaged tyre with a Previously Declared Tyre from their allocation providing it was declared prior to that Meeting or Friday Free Practice (as applicable).

5.16.2 If a Driver damages a tyre during that Meeting or Friday Free Practice (as applicable) and wishes to replace such damaged tyre with a tyre that has not been declared prior to that Meeting or Friday Free Practice (as applicable):

(A) that Driver must obtain the prior approval of the Technical Team;

(B) that Driver must declare such replacement tyre(s) to the Technical Team no later than two hours after the end of the relevant Qualifying Session, Round or Friday Free Practice; and

(C) that Driver will start from the back of the grid for the next Round.

5.17 Control of Fuel

5.17.1 The only fuel to be used in a Car is Carless Hiperflo R20 as supplied by Vital Equipment in accordance with the Motorsport UK Regulations and no additives are permitted.

5.17.2 Refuelling of a Car during each Event is forbidden. Where refuelling or defueling a Car during a Meeting is permitted, the Entrant must ensure that, in addition to the individual that is refuelling or defueling the Car, there must be a second individual present with a fire extinguisher during the refuelling or defueling process who is adequately trained in the use of the fire extinguisher.

5.17.3 Should a team wish to refuel the car using a closed loop refuelling system, the Car must be fitted with the refuelling plate with Part Number MT001235A as supplied by Manthey Racing or Porsche Motorsport. All other refuelling plates are prohibited.

5.17.4 The Scrutineers are authorised to take fuel samples from a Car at any time during an Event. The only method for removing fuel from the Car for scrutineering is via the de-fuelling coupling in the luggage compartment, shown below at item 2. Any removal of fuel may only be completed using the cars on-board fuel pumps. For the avoidance of doubt, no external pumps are to be used and no part of the fuel system is to be disassembled.

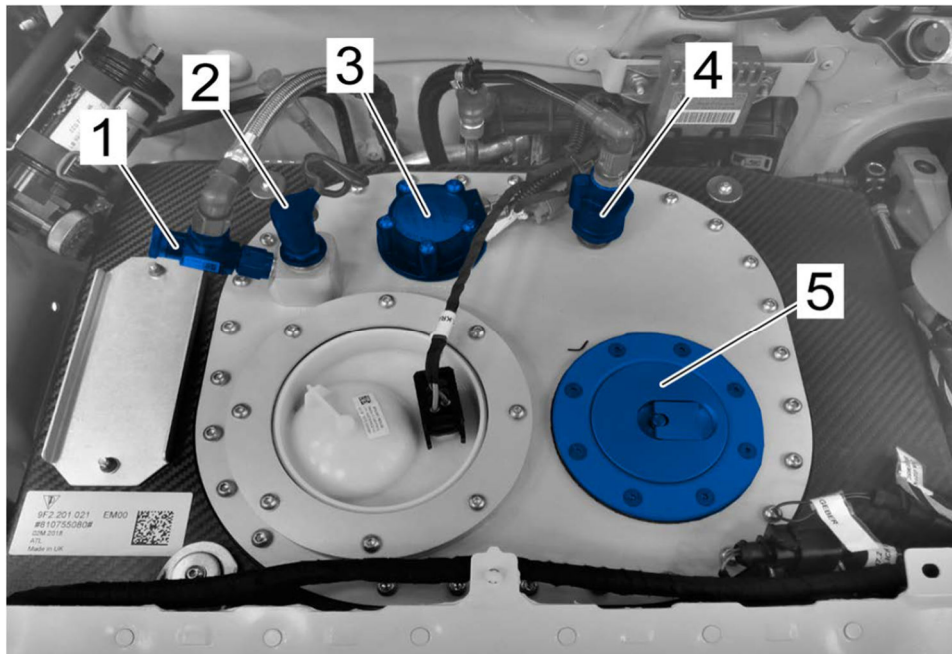

5.17.5 A Car must have a minimum of three litres of fuel in the tank for sampling before, during and after each Event.

5.17.6 The temperature of the fuel in a Car will be taken at the fuel tank. At no time is the temperature of the fuel to be lower than the lowest recorded outdoor air temperature in the last 24 hours (this will be available from the Technical Team).

5.18 Noise test

5.18.1 Noise limits will be measured in accordance with Motorsport UK Regulation J5.18.

5.18.2 The maximum permitted level for this method of measurement will be 96dB(A) at 2.0m / 108dB(A) at 0.5m with the engine at 75% maximum rpm.

5.19 Radio

5.19.1 The use of any kind of radio-based information transmission in a Car is prohibited.

5.20 ECU

5.20.1 The engine electronic control unit must be sealed by Porsche (or Porsche Group) for each Meeting and Friday Free Practice for that Meeting. The Technical Team reserves the right to re-program the electronic control unit at any time during those Events.

5.20.2 The Technical Team and the Scrutineers may check or exchange the electronic control unit or record engine data at any time during each Meeting and Friday Free Practice for that Meeting.

5.21 Data

5.21.1 Use of the Data System in each Car is mandatory. The Data System is assigned to the chassis number of each Car and must not be exchanged.

5.21.2 All recorded data from the Data System relating to Events must be made available to the Technical Team and the Scrutineers. No such data may be deleted by an Entrant or Driver prior to such data being provided to Porsche.

5.21.3 Any additional electrical connection to a Car's wiring harness is forbidden and the use of any other electronic device (including any mobile phone or tablet device) within a Car is forbidden.

5.21.4 No Entrant or Driver may use any computer and/or test equipment in the Pit Lane during any Qualifying Session or Round, other than an Entrant may use computers and/or test equipment for the sole purposes of recording lap times, setting up each Car and to ascertain climatic conditions. For the avoidance of doubt, no Entrant or Driver shall connect a computer and/or test equipment to a Car at any time whilst in the Pit Lane.

EXECUTION VERSION

5.21.5 The Technical Team reserves the right to re-program the electronic control units and to reseal the plug-in connector at any time during each Event.

5.21.6 Porsche may share Driver and/or Entrant data with the Porsche Group to help diagnose faults and improve the reliability of its race cars.

5.22 Cameras

5.22.1 Each Driver must have their Car fitted with the following cameras (the "Cameras" and each a "Camera"):

(A) if requested by the Broadcaster, the camera of the Broadcaster (the "Broadcaster Camera"); and

(B) a Video Data Logger.

5.22.2 Save for the Cameras or otherwise with the prior written consent of the Championship Coordinator, no camera may be fitted in a Car.

5.22.3 Once fitted into a Car, the Cameras must not be tampered with. The Video Data Logger remains the property of RaceLogic and the Broadcaster Camera remains the property of the Broadcaster. On receipt of the Video Data Logger, each Entrant must follow the process specified by Porsche to verify its condition. Each Driver shall promptly return any Video Data Logger in their possession when requested by Porsche. Without prejudice to the generality of the foregoing, each Driver must return the Video Data Logger to Porsche by no later than fourteen days after the last Round of the Championship and any Driver that fails to return the Video Data Logger by such date will pay to Porsche a sum equal to £100 for each day that the Video Data Logger is not returned. Each Driver agrees to indemnify Porsche and keep Porsche indemnified at all times against all or any costs, claims, damages or expenses incurred by Porsche with respect to any loss of, damage to, or destruction of, any Video Data Logger that is in that Driver's possession. Without prejudice to the generality of the foregoing, if any Driver fails to return the Video Data Logger to Porsche when required in accordance with this Section 5.22.3 of this Part B, or such Video Data Logger is returned not in working order, then such Driver shall be liable to, and promptly on demand pay, Porsche for the full replacement value of that Video Data Logger.

5.22.4 Each Driver is liable to pay Porsche or the Broadcaster (as appropriate) for any costs incurred in relation to any repair required as a result of any damage to a Camera caused whilst that Camera is installed in that Driver's Car (including, if the Camera cannot be replaced, the cost to replace such Camera).

5.22.5 The Driver must ensure that each Camera is switched on prior to the time of the two-minute Round start signal. Any Driver that fails to comply with the foregoing is liable to a fine of £1,000 per Camera for each offence.

5.22.6 The copyright in any visual, audio or audio-visual footage produced via the Broadcaster Camera is owned by the Broadcaster. No Driver or Entrant may use any such footage save as set out in Section 6.11.

5.22.7 Porsche shall provide to each Driver, and each Driver shall use, an SD memory card for use in the Video Data Logger during each Qualification Session and Round. Porsche may provide training on how to use the Video Data Logger.

5.22.8 The copyright in any data, visual, audio or audio-visual footage produced via the Video Data Logger (the "VDL Materials") is owned by Porsche. No Driver or Entrant may use any such footage save as set out in Sections 6.10 and 5B.22.9.

5.22.9 Porsche licences Drivers and Entrants to download, retain and use the VDL Materials on a revocable, limited basis as follows:

(A) Subject to Section 5.22.9(B) of this Part B, each Driver and Entrant is permitted to download the VDL Materials in relation to a Meeting only after the end of the Qualifying Session on the Saturday of that Meeting and following the conclusion of any judicial procedure, and within a set time period to be notified by Porsche.

(B) At any Meeting, Porsche may (in its sole discretion) permit Drivers and Entrants to download the VDL Material earlier than the time set out at Section 5.22.9(A) of this Part B. If Porsche so determines, the relevant time and any other conditions will be notified in a Bulletin.

(C) The Driver or Entrant is responsible for downloading the VDL Materials onto their own device.

(D) When downloading the VDL Materials onto their own device, the Driver or Entrant must not delete the VDL Materials from the Video Data Logger.

EXECUTION VERSION

- (E) The VDL Materials must not be published or shared with anyone other than the Driver or Entrant until 9.00 am (UK time) on the second Monday after the end of the Meeting.
- (F) After 9.00 am (UK time) on the second Monday after the end of the Meeting, the Driver or Entrant may use and/or publish the footage but only for promotional purposes.
- (G) Drivers and Entrants must use the VDL Materials at all times in the best interests of the Championship. Any improper behaviour relating to the VDL Materials, such as (without limitation) corrupting, tampering with or deleting the information stored on the SD card, or using the VDL Materials in relation to any discussion of a racing incident in a public forum, will be grounds for Porsche to revoke the licence set out in this Section 5.22.9 of this Part B, and, in addition, any Driver or Entrant that deletes, corrupts or tampers with the VDL Materials stored on the Video Data Logger will incur a fine of £1,000 for each offence.
- (H) At the end of the Season, or if the trial is ended prematurely, any Driver who or Entrant that has already downloaded any VDL Materials may retain those VDL Materials, subject to compliance with this Section 5.22.9 of this Part B.

The licence granted by Porsche in this Section 5.22.9 of this Part B may be revoked by Porsche at any time in its discretion with immediate effect, either for particular Drivers and/or Entrants or for all Drivers and/or Entrants.

5.23 Bodywork

- 5.23.1 The bodywork of each Car must remain in the condition it was in when the Car was originally built by Porsche (or the Porsche Group).
- 5.23.2 Adding tape to any join or edge on the bodywork or the underside of a Car is prohibited. Taping the original fuel filler flap on the wing of a Car is permitted.
- 5.23.3 The roof shall be fitted with a KED system to assist with removal of the Driver in the event of an accident. The hatch measures 565mm x 475mm and is retained by seven livelock fixings. The livelocks must be accessible at all times and must not be painted or covered.

5.24 Windscreen, windows and ventilation

- 5.24.1 To protect a Car's windscreen, tear-off screens may be fitted to that Car's windscreen. The fitting must be controlled and approved by the Scrutineers and must be removed on the request of the Scrutineers. Only windscreens with the following part number may be used:

9F2845011

- 5.24.2 Only the genuine side and rear windows (in accordance with Appendix J to the International Sporting Code) of a Car are to be used as supplied by Porsche.

5.25 Rear wing

- 5.25.1 The position of the wing of each Car may only be changed within the specified range of the rear wing pylons. All parts must be unmodified and as supplied with the Porsche 718 Cayman GT4 RS Clubsport.

5.26 Additional requirements

- 5.26.1 The seals or markings applied to a Car must not be damaged, altered or copied. All modifications to a Car that are authorised by the Technical Regulations must serve the intended purpose only.
- 5.26.2 Porsche reserves the right to impound and seal any Car or any of its associated parts at the end of any Event and send such Car or parts (as appropriate) to the Porsche Motorsport Technical workshop for further Scrutineering and the relevant Driver has the right to be present during such Scrutineering (but failure to attend will be deemed to mean that the Driver agrees with the findings should the Scrutineering find any non-compliance with the Technical Regulations). The collection of the Car or parts (as appropriate) after such Scrutineering will be the responsibility of, and at the cost of, the relevant Driver.

EXECUTION VERSION

- 5.26.3 Any Entrant running two or more Cars in the Championship must own and have available at each Event a Deutronic DBL Charging Computer and cable (Deutronic DBL Charging Computer part no.: ASE44703900000. Cable part no.: ASE62200700020).

5.27 Virtual Flag System

- 5.27.1 All Entrants, prior to the Championship Launch Day, must:
- (A) purchase a loom and antenna kit from Porsche; and
 - (B) install the racelink receiver (the “Racelink Receiver”) that the Entrant has received from Porsche, (together, the “Virtual Flag Equipment”).
- 5.27.2 All Entrants must install the Virtual Flag Equipment, in accordance with the instructions provided, in the Cars by the Championship Launch Day (or, for any Driver that registers for the Championship after the Championship Launch Day, prior to the first Meeting in which that Driver participates) and the Virtual Flag Equipment must remain installed for the Season.
- 5.27.3 The Virtual Flag Equipment will allow each Driver to use the virtual flag system (the “Virtual Flag System”) during Meetings. The Virtual Flag System will notify Drivers of any flags at the Track through sending digital messages to the Car dashboard. Notwithstanding the foregoing, the Virtual Flag System is a supplementary aid to Drivers only which in no way overrides or replaces the on-Track flags. In the event of any discrepancy between the flags displayed on-Track and the flags displayed under the Virtual Flag System, the on-Track flags shall prevail. Drivers are not permitted to rely on the Virtual Flag System at any time and Porsche, the Organising Club, TOCA and/or Timing Solutions Limited (as the entity from which Porsche hires the Racelink Receiver) shall be in no way liable for any malfunction of the Virtual Flag Equipment.
- 5.27.4 The Racelink Receiver, as between Porsche and the Entrants/Drivers, remains the property of Porsche and each Entrant will be required to return it (including all components of the Racelink Receiver) to Porsche on or before the date so determined by Porsche at Porsche’s sole discretion. In the event that an Entrant fails to return the Virtual Flag Equipment or any component in accordance with this Section 5.27.4 of this Part B, or the Virtual Flag Equipment or any component is returned not in working order, that Entrant will be liable to, and promptly on demand pay, Porsche for the cost of that Virtual Flag Equipment or component (as applicable).

5.28 Safety Self-Declaration Form

- 5.28.1 Each Entrant is required to complete the Safety Self-Declaration Form set out in Appendix 11 and return it to the Scrutineers by the date so notified to the Entrants by the Championship Coordinator. The Safety Self-Declaration Form must be completed by an individual who is suitably qualified to inspect the Car.

5.29 Seals

- 5.29.1 The following seals must be affixed to the Car:

Engine:

- Valve cover, left (1x)
- Valve cover, right (1x)
- Oilsump (1x)

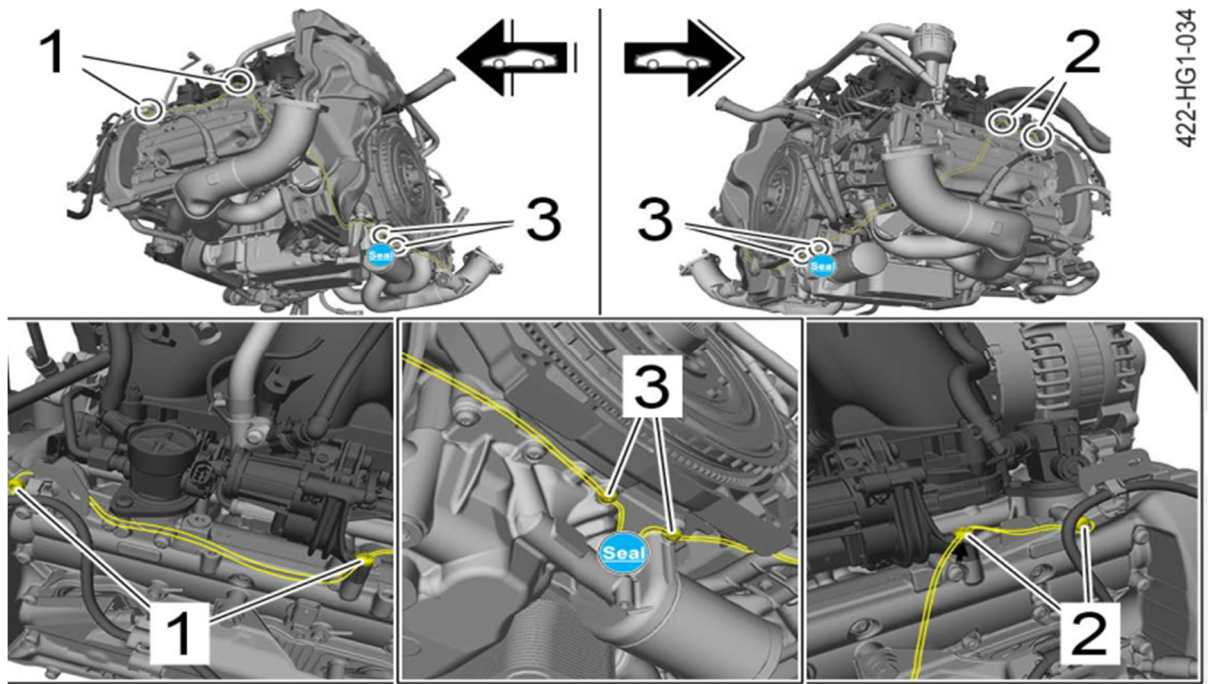

5.29.2 If seals and marks are applied to the Car by the Technical Scrutineers or Dr. Ing. h.c. F. Porsche AG, these must not be damaged, changed or reproduced. If one or more damaged or missing seals or markings are discovered, the Car can be excluded from all Events until they are replaced.

| | |
|----------|-------------------------------|
| 6 | COMMERCIAL REGULATIONS |
|----------|-------------------------------|

6.1 Introduction

- 6.1.1 The Commercial Regulations form part of the terms and conditions of participation in the Championship applying to each Driver and each Entrant. No Driver or Entrant may participate in the Championship unless they have/it has accepted the Commercial Regulations and agreed (in the case of an Entrant, on its own behalf and on behalf of each of its Drivers and other persons connected to it) to be bound and to abide by them. Participation in the Championship will be deemed to signify acceptance and agreement of the Commercial Regulations.
- 6.1.2 The Commercial Regulations identify the respective commercial rights of Porsche, the Drivers and the Entrants in connection with the Championship.
- 6.1.3 Porsche has the right to amend, vary or add to the Commercial Regulations from time to time. Such amendments, variations or additions shall be notified to each Driver and Entrant by way of a Bulletin. Continued participation in the Championship by a Driver and Entrant after receipt of a Bulletin shall be deemed to signify acceptance and agreement of the Commercial Regulations as amended, varied or added to.
- 6.1.4 Breach of the Commercial Regulations by a Driver or Entrant will incur the penalties set out in Section 6.13. In the case of an alleged breach of any of the Commercial Regulations, the decision of the Championship Coordinator is final as to the culpability and penalty and there is no appeal to the MSC National Court. Continued future participation in the Championship may not be permitted until any fine imposed pursuant to the Commercial Regulations is paid in full.

6.2 Commercial Rights

- 6.2.1 Save as set out in Section 6.2.2, as between Porsche, each Driver and each Entrant:
- (A) Porsche shall own and control, and may exploit in its absolute discretion, all of the Commercial Rights;
 - (B) Porsche may exploit the Commercial Rights itself, authorise others to exploit all of some of the Commercial Rights and/or it may decide not to exploit (and not to allow others to exploit) some of the Commercial Rights; and
 - (C) Porsche shall retain all revenues arising from the exploitation of the Commercial Rights.
- 6.2.2 Porsche grants to each Driver and each Entrant the right to exploit the Commercial Rights set out in Section 6.8 (the "**Reserved Rights**"). The Commercial Rights, less the Reserved Rights, shall be the "**Porsche Commercial Rights**".
- 6.2.3 Each Entrant and each Driver shall support the programme established by Porsche for the exploitation of the Porsche Commercial Rights. In particular, no Driver or Entrant shall, without the prior written consent of Porsche:
- (A) work with any other Driver or Entrant to market any or all of the Reserved Rights collectively; and/or
 - (B) exploit any Reserved Rights in a manner that conflicts with the terms of the Commercial Regulations or that, in the opinion of Porsche, detracts from the primacy of the programme established by Porsche for the exploitation of the Porsche Commercial Rights or is demeaning or damaging to the reputation of Porsche, the Championship, any Commercial Partner or any other Driver or Entrant,

and each Driver and each Entrant agrees that, where the manner of their or its exercise of the Reserved Rights interferes with Porsche's exploitation of the Porsche Commercial Rights, upon request by Porsche, such Driver or Entrant shall immediately cease and desist from exercising the Reserved Rights in that manner.

6.3 Commercial Partners

- 6.3.1 Porsche may, in its absolute discretion, appoint Commercial Partners from time to time during the Season. As at the date of these Regulations, the Commercial Partners are: RaceLogic, and Michelin Tyres. Any amendment to this list of Commercial Partners shall be notified to each Entrant via a Bulletin.
- 6.3.2 Each Driver must wear the cap branded with the marks of Michelin Tyres (or such alternative tyre manufacturer notified to Entrants by Porsche via a Bulletin) provided by Porsche whilst on the podium in accordance with Section 3.15.5.

EXECUTION VERSION

- 6.3.3 Drivers must purchase a race suit that complies with the Motorsport UK Regulations for use at all Events (the "**Race Suit**"). Around the start of the Season, the Championship Coordinator will provide each Driver with certain badges and patches of the Championship Marks that each Driver must attach to their Race Suit as specified by the Championship Coordinator (or, on request, provide copies of the relevant artwork of the Championship Marks to the Driver to enable him to have those marks embroidered onto their Race Suit).
- 6.3.4 Each Entrant shall permit Porsche to brand the Cars, including on the side of the Cars as set out in Motorsport UK Regulation H28 with the Championship Marks.
- 6.4 **Specific regulations relating to broadcasting**
- 6.4.1 Porsche may, in its absolute discretion, appoint the Broadcaster(s) from time to time during the Season. As at the date of these Regulations, the Broadcaster is ITV. Any amendment to the identity of the Broadcaster shall be notified to each Entrant by way of a Bulletin.
- 6.4.2 All Drivers and Entrants are obliged to assist the Broadcaster(s) in the filming of the Championship through the granting of interviews when requested and other reasonable requests of the Broadcaster or Porsche. Drivers must ensure they are wearing their Race Suit when giving interviews and must not remove, obscure or alter the Championship Marks on such Race Suits.
- 6.4.3 Each Driver must ensure that their Car carries the Cameras in accordance with Section 5.22 Part A or Part B (as applicable).
- 6.4.4 Each Driver selected to carry a Broadcaster Camera is required to display a Championship Logo in front of the Broadcaster Camera. No other advertising will be permitted in the cockpit or in view of the Broadcaster Camera.
- 6.4.5 Each Driver and Entrant is prohibited from trying to influence the editorial decision of the Broadcaster in connection with the Championship as it is shown on television.
- 6.4.6 All television rights (as between Entrants, Drivers and Porsche), including all footage recorded at Rounds, are the property of Porsche. Any broadcasts, rebroadcasts or reproduction without the express written permission of Porsche is strictly forbidden, subject to Section 5.22.9 Part A or Part B (as applicable).
- 6.5 **Use of Championship Marks**
- 6.5.1 Porsche hereby grants to each Driver and each Entrant, by virtue of their registration and participation in the Championship, a non-exclusive, non-transferrable, non-sub-licensable, royalty-free, revocable licence to use the Championship Marks in accordance with the terms of this Section 6.5.
- 6.5.2 Each Driver and each Entrant shall comply with the directions of Porsche with regard to the use of the Championship Marks. General directions shall be notified to each Driver and Entrant by way of a Bulletin, which may (if the circumstances so warrant) be supplemented by instructions to individual Entrants and Drivers.
- 6.5.3 Any and all uses of the Championship Marks shall be subject to the prior written approval of Porsche and/or one or more of its Commercial Partners, as applicable.
- 6.5.4 Ownership of the Championship Marks vests in Porsche and/or one or more of its Commercial Partners, as applicable. All goodwill generated by a Driver's or Entrant's uses of the Championship Marks is held by such Driver or Entrant on trust for the owner of the Championship Marks.
- 6.5.5 For the avoidance of doubt, save as set out in this Section 6.5 no Driver, Entrant or any other party participating in the Championship shall obtain any claim, right, title or interest in any Porsche Group patents, designs, trade marks and trade names (whether registered or unregistered), copyright and related rights, database rights or any other intellectual property and similar or equivalent rights anywhere in the world that currently exist or are recognised in the future (including all applications, extensions and renewals in relation to any such rights) by virtue of their registration, participation in the Championship or howsoever otherwise.
- 6.6 **Use of Entrant Logo and Driver imagery**
- 6.6.1 Each Entrant agrees that Porsche may use on a worldwide basis (and/or licence others - such as the Commercial Partners - to use) without charge (both during the Season and on a perpetual basis):

EXECUTION VERSION

- (A) the Entrant Logo, name, nickname(s), colours, regalia and results;
- (B) the logos, names, branding, images and representations of the Competitor Sponsors of that Entrant;
- (C) images and representations of the Cars (including any Competitor Sponsor branding on such Cars) of that Entrant; and
- (D) any audio, visual or audio-visual materials produced during the Season that feature the Entrant and/or any of the materials listed in Sections 6.6.1(A) to (C) (inclusive) above,

in each case whether or not in conjunction with the Championship Logo for the following purposes:

- (i) in connection with the transmission (via any medium) of coverage of the Championship;
- (ii) in advertising and promotional material for the Championship or future championships administered by Porsche (such as television promotions, posters and advertising);
- (iii) in advertising and promotional material produced by or on behalf of the Commercial Partners from time to time (such as print advertising, outdoor advertising, point of sale advertising, trade-on-trade promotions, programming and website material) to promote their association with the Championship or future championships administered by Porsche, in each case provided always that no such use shall suggest individual endorsement by that Entrant of the products or services of any of such Commercial Partners;
- (iv) on merchandising or other marketing material relating to the Championship or future championships administered by Porsche; and
- (v) in connection with (and including within) interactive computer games and/or video games (including for the purposes of e-sports, e-sports challenges and championships, and other e-sports-related advertising, promotions, merchandising, marketing or other activities, in each case whether in person or virtual, including on any social media platform, broadcasting platform, or other form of media).

6.6.2 Each Driver agrees that Porsche may use on a worldwide basis (and/or license others - such as the Commercial Partners - to use) (both during the Season and on a perpetual basis):

- (A) the names, images, voices, relevant racing statistics and other attributes of that Driver;
- (B) the logos, names, branding, images and representations of that Driver's Competitor Sponsors; and
- (C) any audio, visual or audio-visual materials produced during the Season that feature the Driver and/or any of the materials listed in Sections 6.6.2(A) and (B),

in each case whether or not in conjunction with the Championship Logo for the following purposes:

- (i) in connection with the transmission (via any medium) of coverage of the Championship;
- (ii) in advertising and promotional material for the Championship or future championships administered by Porsche (such as television promotions, posters and advertising);
- (iii) in advertising and promotional material produced by or on behalf of the Commercial Partners from time to time (such as print advertising, outdoor advertising, point of sale advertising, trade-on-trade promotions, programming and website material) to promote their association with the Championship or future championships administered by Porsche, in each case provided always that no such use shall suggest individual endorsement by that Driver of the products or services of any of such Commercial Partners;
- (iv) on merchandising or other marketing material relating to the Championship or future championships administered by Porsche; and
- (v) in connection with (and including within) interactive computer games and/or video games (including for the purposes of e-sports, e-sports challenges and championships, and other e-sports-related

advertising, promotions, merchandising, marketing or other activities, in each case whether in person or virtual, including on any social media platform, broadcasting platform, or other form of media).

6.6.3 For the avoidance of doubt, the agreements in Sections 6.6.1 and 6.6.2 shall survive the termination or expiry of the relevant Entrant or Driver's participation in the Championship.

6.6.4 Each Entrant and Driver hereby represents and warrants that:

- (A) the exercise of the rights under Sections 6.6.1 and 6.6.2 by Porsche (and any other third parties that Porsche licenses such rights to) shall not infringe the rights, including the intellectual property rights, of any third party; and
- (B) it has all rights, licences and permissions necessary from the relevant Competitor Sponsors in order to grant the rights in Sections 6.6.1 and 6.6.2.

6.6.5 Each Entrant shall indemnify and hold Porsche, its affiliates and third party licensees harmless against any losses, liabilities, costs, claims, damages or expenses suffered or incurred by such parties as a result of any claim by a third party that the possession and/or use of the materials set out in Section 6.6.1 infringe the rights (including the intellectual property rights) of a third party. Porsche may at its option satisfy such indemnity (in whole or in part) by way of deduction from any payments due to the Entrant.

6.6.6 Each Driver shall indemnify and hold Porsche, its affiliates and third party licensees harmless against any losses, liabilities, costs, claims, damages or expenses suffered or incurred by such parties as a result of any claim by a third party that the possession and/or use of the materials set out in Section 6.6.2 infringe the rights (including the intellectual property rights) of a third party. Porsche may at its option satisfy such indemnity (in whole or in part) by way of deduction from any payments due to the Driver or that Driver's Entrant.

6.7 **Stickers and flags**

6.7.1 Porsche will provide to each Driver stickers and livery of the Championship, its Cars and the Commercial Partners (the "**Stickers**") and each Driver must display the Stickers in their Car as directed by Porsche.

6.7.2 A Driver may (provided that these items are available at the Event) have their (or their Entrant's) transporter fitted with a minimum of two flagpoles, each six metres high (from the ground). Prior to the start of the Season, the Championship Coordinator will (on request) supply a flag of the Championship free of charge to each Entrant, which shall be flown on one flagpole on the transporter, and the Entrant may then use the second flagpole to fly a flag of the Entrant.

6.8 **Reserved Rights**

6.8.1 Subject to Section 6.8.2, each Driver and each Entrant may enter into agreements with third parties which grant such third parties the right to sponsor that Driver or Entrant (a "**Competitor Sponsor**").

6.8.2 An Entrant or Driver may only appoint a Competitor Sponsor if it complies with the following conditions:

- (A) the potential Competitor Sponsor does not operate in, and is not associated with, any Excluded Category without the prior written consent of the Championship Coordinator;
- (B) the potential Competitor Sponsor is not granted any rights for exercise in any Excluded Category;
- (C) the rights being granted to the potential Competitor Sponsor comply with applicable law and regulations (including the UK Code of Broadcast Advertising issued by the Committee of Advertising Practice); and
- (D) the Entrant or Driver must obtain the prior written consent of Porsche.

6.8.3 Each Driver may display stickers on their Car that bear the marks of Competitor Sponsor(s), provided that:

- (A) such stickers do not overlap, obscure or in any other way interfere with the display of the Stickers or the starting numbers;
- (B) such stickers are approved in advance by the Championship Coordinator and are in the position, size and colour as stipulated by the Championship Coordinator; and

EXECUTION VERSION

- (C) such stickers comply with Motorsport UK Regulations H27 and H28.
- 6.8.4 Each Driver and Entrant may post communications on Social Media Platforms in relation to the Championship, provided that they or it at all times complies with the Social Media Policy.
- 6.9 **"Behind the scenes" filming**
- 6.9.1 Each Entrant may arrange for "behind the scenes" footage to be produced at each Event subject to complying with the following conditions:
- (A) any Entrant wishing to arrange for "behind the scenes" filming must obtain the prior written consent of the Championship Coordinator (who in turn will require the consent of (i) David Frances (ITV Sport BTCC Director) and (ii) Alan Gow in assessing whether or not to grant consent) by submitting to the Championship Coordinator all details (including the proposed content and use for the content);
 - (B) media accreditation, via the team, must also be applied for from Simon Melliush (simon@smsportsmedia.com) stating the intention of the person or crew to film video footage, not stills photography;
 - (C) if approved, final accreditation for each Event must be applied for by the filming team, directly through each Track. This includes the requirement to sign on with the Track at each Event. They will issue the Entrant with a bib, which must be worn when filming or the camera operator will be ejected from the Track;
 - (D) even if an Entrant is permitted to arrange for "behind the scenes" filming at an Event, under no circumstances is any Driver or Entrant allowed to film, or to arrange filming of the Pit Lane, the grid, the Parc Fermé, assembly area, technical area, any part of any racing at any Event and/or any moving Cars;
 - (E) subject to Section 6.9.1(D) above, any "behind the scenes" filming that is permitted may only film: (i) in and around the garages (only within the garage, not from the Pit Lane looking into the garage), Paddock areas, spectator and trade areas, transporters, hospitality and motor homes; and (ii) the podium at Meetings but only from behind the crew of the Broadcaster and such filming crew shall not obscure or hinder the Broadcaster's filming of the podium;
 - (F) any film crew undertaking "behind the scenes" filming must remain cognisant of the crew of the Broadcaster, who have priority at all times;
 - (G) the results of any "behind the scenes" filming must portray a positive image of Porsche, the Commercial Partners, the Organising Club, BTCC, TOCA, Motorsport UK, each Track and Track Operator, each Driver, each Entrant, all sponsors of Drivers and Entrants and Officials;
 - (H) any consent granted to "behind the scenes" filming may be withdrawn at any time. If such consent is withdrawn prior to the filming, such "behind the scenes" filming will not take place and, if such consent is withdrawn after the filming, any material produced must not be used and must be immediately destroyed; and
 - (I) any breach of the foregoing terms by any Entrant or by that Entrant's film crew acting on its behalf will result in the immediate withdrawal of the consent to film "behind the scenes" and any material produced must be immediately destroyed.
- 6.10 **Video Data Logger footage**
- 6.10.1 Drivers and Entrants may make the following uses of footage obtained from the Video Data Logger, subject to complying with the following conditions:
- (A) the clips in total must be no more than two minutes in duration;
 - (B) each clip may not be more than 30 seconds of continuous footage;
 - (C) a complete lap may not be shown and must be interspersed with other angles or footage;

EXECUTION VERSION

- (D) any footage containing vision or sound of anything out of the ordinary, negative or untoward (including towards another Driver or Entrant) may not be used. By way of example only, the footage must not show another car spinning off the track, having an incident or a mechanical failure; and
- (E) any such proposed use must be approved in advance by the Championship Coordinator.

6.11 Use of Broadcast Footage

6.11.1 A Driver or Entrant may use Broadcast Footage on its official website or other social media channel (such as YouTube) dedicated to that Driver or Entrant or at an Entrant or Competitor Sponsor function, subject to complying with the following conditions:

- (A) the relevant Driver or Entrant must obtain the consent of the Broadcaster to use the Broadcast Footage by contacting the Championship Coordinator;
- (B) no more than three minutes of clips of Broadcast Footage of a Meeting may be used within the seven days following the relevant Meeting (the “**Restricted Period**”) to protect the exclusive rights of the Broadcaster;
- (C) the clips of any Event used by that Driver or Entrant outside of the Restricted Period must not exceed five minutes in total;
- (D) the Broadcast Footage will be provided free of charge by the Broadcaster, save for any technical fees payable in accordance with Section 6.12;
- (E) the clips may not be used on any generic websites or social media channels not dedicated to the relevant Driver or Entrant (such as a non-specific channel on YouTube);
- (F) the clips must include the Broadcaster's graphic 'bug' (in the top left or right as appropriate) and all other graphics supplied with the clips by the Broadcaster;
- (G) the clips must be acquired directly from the Broadcaster and not filmed or downloaded from a TV screen or illegal feed of the Broadcaster or any other programme;
- (H) the clips will not be digitally altered or enhanced (for example, not alterations may be made to mask or pixilate signature or graphics); and
- (I) for all Rounds: the "GOODYEAR EDIT" is for use by media channels as determined by Simon Melliush (BTCC Press Office) and is not available to Drivers or Entrants.

6.11.2 Subject to the conditions set out in Section 6.11.1, a Driver or Entrant may also sub-license the use of Broadcast Footage to local media news outlets.

6.11.3 Broadcast Footage can (where applicable) be obtained from the Broadcaster in accordance with Section 6.12.

6.12 How to obtain Broadcast Footage

6.12.1 Broadcast Footage can be obtained with the permission of the Championship Coordinator.

6.12.2 If the Championship Coordinator approves a request for Broadcast Footage, the Championship Coordinator will provide the required contact information for obtaining the Broadcast Footage from Porsche's production company.

6.12.3 Any fees associated with obtaining the Broadcast Footage will be borne solely by the individual or entity that requests the Broadcast Footage and shall in no event be payable by Porsche and/or its production company.

6.13 Penalties

6.13.1 The following penalties shall apply to any Driver or Entrant in breach of the Commercial Regulations:

- (A) a fine of £1,000 for each breach;
- (B) a suspension on eligibility for participation in all Events until payment of the fine set out in Section 6.13.1(A) above has been received by Porsche; and

EXECUTION VERSION

- (C) for any serious or continual breach (including a breach of Section 6.8.2), ineligibility for the remainder of the Championship,

in each case unless the Championship Coordinator determines that exceptional circumstances apply (in which case a lesser penalty may apply).

6.13.2 In addition or in lieu of any penalty under Section 6.13.1, the Championship Coordinator may require the relevant Driver or Entrant to take such steps as may be reasonable to mitigate publicly any damage to the reputation of the Championship.

6.13.3 Where, in the opinion of the Championship Coordinator, a Driver or Entrant has by an act (or omission to act or otherwise) brought the Championship, any Event, Porsche or any Commercial Partner into disrepute (including the use or publication or broadcast of derogatory, defamatory, insulting, unfavourable or disrespectful remarks in any media whatsoever) then irrespective of any penalties imposed under the Motorsport UK Regulations, the Championship Coordinator may impose any one or more of the penalties set out in Section 6.13.1.

6.13.4 Nothing in this Section 6.13 shall prevent Porsche from seeking equitable remedies (including injunctive relief and/or specific performance) for any breach of the Commercial Regulations by Drivers and/or Entrants.

6.14 Passes

6.14.1 Porsche shall procure from TOCA and issue to each Driver passes that permit entry to each Round and, for all Meetings, Friday Free Practice ("**Passes**") for use by that Driver and their Entrant in accordance with the following provisions of this Section 6.14.

6.14.2 Drivers shall make applications for Passes by completing the Staff and Vehicle Information Form and returning it to the Championship Coordinator by 19 April 2024. The Championship Coordinator will not process such form unless such form is fully complete. Submission of an incomplete Staff and Vehicle Information Form or late return of such form to the Championship Coordinator may result in no Passes being available for the first Meeting and the withholding of that Driver's entry.

6.14.3 Porsche shall issue to each Entrant Manager six Passes per Car competing in that particular Meeting and Friday Free Practice. The Passes will grant the Passholders access to either the Paddocks or the Pit Lanes and Paddocks (as appropriate).

6.14.4 Each Entrant Manager shall procure that each Passholder is made aware of the terms of this Section 6.14.

6.14.5 Each Passholder waives any and all claims they may have now or in the future and releases from all liabilities and agrees not to take any legal action and to always hold harmless, Porsche, the Organising Club, Motorsport UK, TOCA, the relevant Track Operator and any other participating Entrant and all employees, agents, servants and contractors thereof (the "**Indemnitees**" and each, an "**Indemnitee**") for any personal injury, death, damage or loss of any kind that the Passholder may sustain as a result of or in connection with the Passholder's presence within the relevant Track. The waiver set out in the foregoing shall not apply to any personal injury or death caused by the negligence of the relevant Indemnitee.

6.14.6 The Entrant Manager shall sign on receipt of the relevant Passes for each Meeting and (where applicable) Friday Free Practice. By accepting the issue of a Pass, each Passholder must comply with the following conditions:

- (A) the Pass may only be used to gain access to the areas indicated on the face of the Pass. Any person found within a restricted area without the appropriate Pass may be removed from the Track immediately and/or have their Pass withdrawn;
- (B) no Passholder may allow anyone else to use their Pass, alter or deface any Pass in any way or allow a Pass to be used to authorise the entry of more than one person;
- (C) the Pass shall not be removed from its official lanyard and must be worn around the neck of the relevant Passholder so as to remain clearly visible at all times. It is forbidden to combine with or enclose a Pass within a wallet or holder of any kind (unless supplied by TOCA or Porsche) or to attach additional items of any kind to it;
- (D) the Organising Club, TOCA, the relevant Track Operator and/or Porsche may request further proof of identity in addition to a Pass; and

EXECUTION VERSION

- (E) the Organising Club, TOCA, the relevant Track Operator and/or Porsche may at all times refuse admission to the relevant Track or access to a designated area to any person, notwithstanding that such person may be a Passholder.
- 6.14.7 The Passes remain at all times the property of TOCA and may be issued, altered or withdrawn at any time at the absolute discretion of TOCA and/or Porsche. Passes that have been withdrawn will not, unless under exceptional circumstances, be returned to the relevant Passholder.
- 6.14.8 TOCA and/or Porsche may remove immediately from the Track any Passholder who is found to have violated the conditions set out in Section 6.14.6 and/or withdraw permanently that Passholder's Pass and/or take or institute legal proceedings against that Passholder.
- 6.14.9 The misuse of any Passes allocated to an Entrant will result (without prejudice to any other action which may be taken by TOCA and/or Porsche under the terms of these Commercial Regulations) in TOCA and/or Porsche imposing on the Entrant a fine of £1,000 for each act or misuse of the Pass together with the confiscation of the Pass concerned for such period of time as the Organising Club, TOCA and/or Porsche (as appropriate) shall deem appropriate.
- 6.14.10 Porsche shall issue the Passes for each Event to the Entrant Managers on the Championship Launch Day. Each Entrant Manager must attend the Championship Launch Day to collect the Passes and erect the Entrant's awning (if applicable) for measurement. Passes will not be issued to the Entrant Manager until the plot size for that Entrant has been measured and agreed by Porsche and/or TOCA.
- 6.14.11 If a Championship registration is withdrawn, all Passes issued in connection with that registration must be returned to the Championship Coordinator. Any lost or mislaid passes will be subject to a penalty of £25 per Pass multiplied by the number of remaining Meetings.
- 6.14.12 Passes will not be replaced if they are lost or mislaid unless they have been stolen and a copy of the police report relating to that offence is submitted to the Championship Coordinator.
- 6.15 **Paddock regulations**
- 6.15.1 The terms of this Section 6.15 shall apply to the use of Paddock areas at Tracks on the Porsche Test Days, Friday Free Practices and Meetings.
- 6.15.2 The Entrant Manager shall specify on each Staff and Vehicle Information Sheet the space that Entrant requires in the Paddock. Porsche and/or TOCA shall assess the individual requirements of each Entrant on the Championship Launch Day and will notify each Entrant Manager of the space that the Entrant Manager's Entrant has been allocated in the Paddock.
- 6.15.3 Subject to Section 6.15.5 and the remainder of this Section 6.15.3, each Entrant will be permitted one transporter and awning to be parked in their designated Paddock. Any Entrant requiring an additional awning must make a request in writing to the Championship Coordinator prior to the first Event. Only Entrants running five or more cars will be permitted an additional awning. Entrants running three or more cars may be permitted additional space for a support vehicle/flat patch. Awnings are not permitted on support vehicles. Entrants are not permitted to park any car that is not a Car under the awning referred to in this Section 6.15.3. A temporary floor structure and temporary walls must be installed within the awning. The awning, temporary floor structure and temporary walls must be well-presented and clean at the time it is erected each Meeting. Please refer to Section 3.14.3 regarding the mandatory provision of fire extinguishers.
- 6.15.4 Any amendment to the car and/or awning size required must be notified to the Championship Coordinator and approved by the Championship Coordinator prior to use.
- 6.15.5 Any Entrant that is running a car in a championship other than the Championship at any meeting that is also a Meeting may make a request in writing and in advance to the Championship Coordinator for amendment or waiver of any requirement of this Section 6.15 in respect of that Entrant. The Championship Coordinator will determine any such request in their sole discretion, and, if the request is granted or partially granted, they may make the grant conditional on such requirements as they determine in their sole discretion.
- 6.15.6 The space allocated in the Paddock by Porsche and TOCA is granted for the preparation of Cars and team catering. It is expressly forbidden to use this space as a hospitality area or trade site area.

EXECUTION VERSION

- 6.15.7 Motorhomes/caravans and private cars (including private cars issued with or without a car park pass) are not permitted within the Paddock at any Track unless in exceptional circumstances and with the prior written approval of the Championship Coordinator. Only essential Entrant vehicles will be issued with vehicle passes to access the Paddock.
- 6.15.8 No hospitality or entertaining will be allowed within the Paddock. Entrants may use an area at the rear of their awning specifically for Entrant team catering only.
- 6.15.9 Only small four-wheeled motorised Paddock vehicles that are authorised by the Organising Club and/or TOCA (as applicable) may be used within the Paddock. Such vehicles may only be used during authorised times and when driven by a current full road traffic licence holder for Entrant-related business. Recreational use is strictly prohibited. For the avoidance of doubt, all two-wheeled transport or human wheeled transport (including bicycles and scooters) is banned from the Paddock area at Events, unless approved by the Championship Co-ordinator. Please note that private cars and vans are not considered as Paddock vehicles. Motorised Paddock vehicles may only be used within the venue during the period from two hours prior to the first scheduled Track activity until one hour after the last Track activity on each day of the Event; there is a total ban on their use outside of these times.
- 6.15.10 There is a speed limit of 10 miles per hour in the Paddock. The only movement of cars permitted in the Paddock is on the way to the assembly area and on the way back from the Parc Fermé with a competent person seated in the Driver's position and in control of the car.
- 6.15.11 Tailgates on transporters must remain closed at all times except when loading and/or unloading cars.
- 6.15.12 Entrants will be issued with a specific time to park up their race transporters in the Paddock at each Event. Access to the Paddock outside that parking-up time is forbidden, unless the express written permission of the Championship Coordinator (after consultation with TOCA) has been obtained to park up at a different time. Verbal permission from employees of the relevant Track will not be accepted.
- 6.15.13 When a race transporter is parked in position in the Paddock at an Event it is expressly forbidden to remove it from its Paddock space until after the start of the third BTCC race of the event organised by TOCA, unless the express permission of Porsche and/or TOCA or its appointed representative has been obtained to remove it earlier, and awnings may not be dismantled until after the start of the second BTCC race of the event organised by TOCA, unless notified otherwise by Porsche via a Bulletin.
- 6.15.14 Hard covers should protect any pipes, wires or cables trailing from motorhomes, transporters and/or generators where they will be crossed by pedestrians and/or vehicles.
- 6.15.15 All Paddock vehicles that require personnel to be on the roof (i.e. to affix awnings or flag poles/flags) must have relevant safety equipment fitted. Any personnel on the roof of such Paddock vehicles must wear the relevant safety harnesses which must be affixed to the equipment on the roof.
- 6.15.16 All health and safety regulations (as well as any such directives) issued by Porsche, the Organising Club, TOCA, Motorsport UK, the FIA and/or the relevant Track Operator must be complied with at all times.
- 6.15.17 It is a condition of registration of Paddock vehicles that third party insurance is in place. Drivers and Entrants are reminded that it is a criminal offence for any person to ride or drive any motor vehicle on the roads or other public areas under the control of the venue promoters unless they are covered by a minimum of third party insurance.
- 6.15.18 It is an offence for any person to ride or drive any motor vehicle on the roads or other public areas under the control of Porsche unless they are covered by third party insurance. It is a condition of registration that such insurance is in place. A copy of the policy must be lodged with the Championship Coordinator before the first Meeting of the Season.
- 6.15.19 At all Meetings, Entrants should use their best endeavours to refrain from using 'single use plastics' within the Paddock area, their garages or awnings, or hospitality areas. In this respect 'single-use' is a term which can refer to any plastic item either designed to be used for one time, or likely to be used in that way, within the Paddock. Such items include (but are not limited to) disposable single-use plastic bottles of water or drinks, plastic cups, plastic cutlery, plastic straws, thin plastic carrier bags, plastic drink stirrers etc. An Entrant which has no practical alternative to the use of a fully recyclable single use plastic item due to an existing commercial partnership, must first submit for approval a comprehensive plan for the collection within the Paddock and the recycling of those items including providing evidence as to the completion of their recycling after each event.
- 6.15.20 Any infringement of the provisions of this Section 6.15 shall be subject to the following fines imposed by TOCA and/or the Championship Coordinator:

EXECUTION VERSION

- (A) first offence of the same type under this this Section 6.15: £1,000;
- (B) second offence of the same type under this this Section 6.15: £2,000;
- (C) third and further offences of the same type under this this Section 6.15: £5,000;

Each Entrant is responsible for the payment of fines incurred by all vehicles entering the Paddock/Pits on their behalf. TOCA and/or The Championship Coordinator's decision in relation to the fines set out in this Section 6.15 shall be final with no appeal to Motorsport UK under Section 2.

6.16 Confidentiality

6.16.1 Each Driver and each Entrant agrees to keep all Confidential Information confidential at all times and shall not, without the prior written consent of the Championship Coordinator:

- (A) use Confidential Information except strictly as required to perform its obligations under these Regulations and/or the Motorsport UK Regulations; or
- (B) disclose Confidential Information in whole or in part to any third party, save for its professional legal and financial advisers for the purposes of obtaining such advice.

provided that in all cases such disclosing Driver or Entrant informs the recipient of the confidential nature of the Confidential Information before disclosing the same to it and such disclosing Driver or Entrant is, at all times, responsible for the recipient's compliance with the confidentially obligations set out in this Section 6.16.

6.16.2 The provisions of Section 6.16.1 shall not apply to Confidential Information that:

- (A) comes into the public domain otherwise than through the default or negligence of the recipient Driver or Entrant; or
- (B) the recipient Driver or Entrant is required to disclose by law or by the rules of any governmental or other regulatory body including any applicable stock exchange or by a court or other authority of competent jurisdiction provided that, to the extent it is legally permitted to do so, it gives the Championship Coordinator as much notice of this disclosure as possible and takes into account the reasonable requests of the Championship Coordinator in relation to the content of this disclosure.

6.17 Early registration

6.17.1 Subject to Section 6.17.3, each Driver that submits their Registration Form and pays the Registration Fee no later than 5pm on 30 November 2023 will receive a credit of £2,000 (the "**Early Registration Reward A**") within one calendar month following the final Round, provided that:

- (A) the Driver does not owe any amounts to Porsche at that time; and
- (B) the Driver competed in each Round. If, in Porsche's opinion, a Driver was unable to compete in one or more Rounds due to reasons outside of that Driver's reasonable control, Porsche may permit that Driver to be eligible for the Early Registration Reward A.

6.17.2 Subject to Section 6.17.3, each Driver that submits their Registration Form and pays the Registration Fee after 5pm on 30 November 2023 but no later than 5pm on 19 January 2024 will receive a credit of £1,000 (the "**Early Registration Reward B**") within one calendar month following the final Round, provided that:

- (A) the Driver does not owe any amounts to Porsche at that time; and
- (B) the Driver competed in each Round. If, in Porsche's opinion, a Driver was unable to compete in one or more Rounds due to reasons outside of that Driver's reasonable control, Porsche may permit that Driver to be eligible for the Early Registration Reward B.

6.17.3 Any Driver who is entitled to receive a discount in the Registration Fee under the Registration Form as a result of the Driver being: (a) a winner of the 2023 Porsche Carrera Cup; (b) a winner of the 2023 Porsche Sprint Challenge (b) or the winner of the following 2023 British Championships: (i) GT4 Overall champion of the British GT Championship; (ii) Overall champion of the FIA British F4; (iii) GTP Class champion of the Ginetta GT Championship; (iv) Overall champion

EXECUTION VERSION

of the Ginetta Junior Championship; (v) JCW Class in the MINI Challenge Championship; (vi) Porsche Club Motorsport Overall Champion; (vii) Ginetta GT Academy Overall Champion; or (viii) Ginetta GT5 Pro Category Champion, shall be ineligible for Early Registration Reward A or Early Registration Reward B.

APPENDIX 1: CHAMPIONSHIP LIVERY POSITIONS

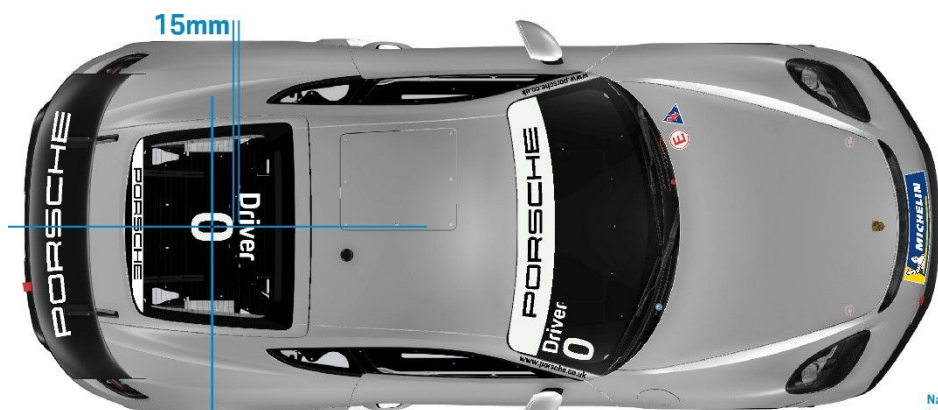

15mm

Centered on screen

PORSCHE

**SPRINT CHALLENGE
GREAT BRITAIN**

 = Reserved for Championship use.

No sponsor decals to be fitted within 50mm of championship livery.

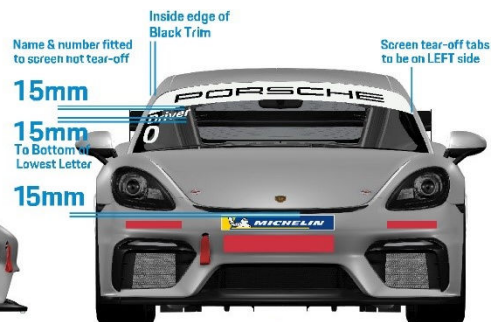

Name & number fitted to screen not tear-off

Inside edge of Black Trim

Screen tear-off tabs to be on LEFT side

15mm

15mm To Bottom of Lowest Letter

15mm



55mm

70mm

350mm



APPENDIX 2: CHAMPIONSHIP REGISTRATION FORM

The 2024 Porsche Sprint Challenge Great Britain (the "**Championship**") will be governed by regulations issued by Porsche (the "**2024 Regulations**"). This Registration Form is made available by Porsche prior to the 2024 Regulations being finalised. Each driver and (if relevant) entrant that is accepted to participate in the Championship will be provided with a copy of the 2024 Regulations and be required to sign and deliver to Porsche an acceptance form to acknowledge and accept the final published version (the "**Acceptance Form**") prior to that driver or entrant's participation in the Championship. If any driver or (if relevant) entrant does not agree to the terms of the 2024 Regulations, he/it shall promptly notify Porsche and, unless Porsche and that driver or entrant agree otherwise, that driver or entrant's registration for the Championship shall cease and Porsche shall refund to that driver or entrant the Registration Fee paid by (or on behalf of) that driver or entrant as set out in Section 6 below.

Any defined terms used in this Registration Form (and not otherwise defined in this Registration Form) shall have the meanings given to them in the regulations for the 2023 Porsche Sprint Challenge (applied with any necessary changes having been made for the Championship).

Please complete this Registration Form in BLOCK CAPITALS and return it to the Championship Coordinator. All sections must be completed in full and this Registration Form must be signed by the potential Driver and, if the Driver represents and is supported by a team, by the Entrant Manager on behalf of that potential Driver's Entrant.

As a responsible business, Porsche takes bribery and money laundering very seriously, and as a consequence Porsche's on-boarding process includes orthodox anti-bribery and anti-money laundering investigations.

This Registration Form forms a binding contract until the end of the Championship season at the end of October 2024.

Please note that no party to this Registration Form is entitled to the cancellation rights set out in Part 3 of the Consumer Contracts (Information, Cancellation and Additional Charges) Regulations 2013 on the basis that this Registration Form concerns the supply of services related to leisure activities for a specific period of performance.

SECTION 1: DRIVER DETAILS

Please provide the following information about the Driver:

Full name (including any middle names): _____

Home address: _____

Date of birth: _____

Nationality: _____

Preferred contact telephone number: _____

Alternative contact telephone number: _____

Email address: _____

BARC membership number and expiry date: _____

Licence grade/issuing ASN*: _____

*Note: the minimum licence grade for the RS Clubsport is Race National (or equivalent) and the minimum grade for the Clubsport is Race Club (or equivalent).

Licence number: _____

EXECUTION VERSION

Please also provide the details of the person that Porsche should contact in the event that the Driver is involved in a serious accident:

Name: _____

Address: _____

Telephone number: _____

If the Driver is under 18 years of age, please also provide the following information for the Driver's parent or legal guardian:

Name: _____

Address: _____

Telephone number: _____

Email address: _____

Bank details (for payments to/from Porsche, including prize monies. Please note that prize money must be paid directly into the Driver's personal account).

Account name: _____

Account number: _____

Sort code: _____

Swift code: _____

Bank name: _____

Bank address: _____

IBAN: _____

SECTION 2: TEAM DETAILS

If the Driver represents an Entrant, please provide the details of that Entrant:

Entrant name: _____

Address: _____

Telephone number: _____

Email address: _____

Entrant Manager: _____

Licence number: _____

Type of legal entity (please tick where relevant or otherwise specify):

- Limited Company
- Limited Liability Partnership
- Partnership
- Unincorporated Association
- Other (please specify):

Entity name (please supply registered name, if applicable): _____

Address (please supply registered address, if applicable): _____

Registered number (if applicable): _____

Bank details (for payments to/from Porsche, including any registration fees paid by the Entrant):

Account name: _____

Account number: _____

Sort code: _____

Swift code: _____

Bank name: _____

Bank address: _____

IBAN: _____

SECTION 3: CAR DETAILS

Please provide the details of the Car:

Model: _____

Model year: _____

Chassis number: _____

SECTION 4: CHAMPIONSHIP SCHEDULE

| Rounds | Circuit | Date |
|----------------------|------------------------|------------------------|
| Rounds 1, 2 and 3 | Snetterton (300) | 25 – 26 May 2024 |
| Rounds 4, 5 and 6 | Oulton Park | 22 – 23 June 2024 |
| Rounds 7, 8 and 9 | Croft | 27 – 28 July 2024 |
| Rounds 10, 11 and 12 | Donington Park (GP) | 24 – 25 August 2024 |
| Rounds 13, 14 and 15 | Silverstone (National) | 21 – 22 September 2024 |
| Rounds 16, 17 and 18 | Brands Hatch (GP) | 5 – 6 October 2024 |

SECTION 5: CATEGORY SELECTION

Please tick where relevant to indicate the Category in which the Driver wishes to compete.

Professional

Amateur

SECTION 6: PAYMENT OF THE REGISTRATION FEE

The Registration Fee for the Championship is £20,000 plus VAT*.

*save for if the Driver was the winner of the following 2023 British Championships: (i) GT4 Overall champion of the British GT Championship; (ii) Overall champion of the FIA British F4; (iii) GTP Class champion of the Ginetta GT Championship; (iv) Overall champion of the Ginetta Junior Championship; (v) JCW Class in the MINI Challenge Championship; (vi) Porsche Club Motorsport Overall Champion; (vii) Ginetta GT Academy Overall Champion; or (viii) Ginetta GT5 Pro Category Champion, in which case the Registration Fee will be half of the abovementioned price.

The Registration Fee must be paid by bank transfer using the following bank account details:

Account name: Porsche Cars Great Britain Limited
Account number: 30658782
Sort code: 20-71-29
Swift code: BARCGB22
Bank name: Barclays Bank PLC
Bank address: 1 Churchill Place, London E14 5HP
IBAN: GB58 BARC 2071 2930 6587 82

Please tick where relevant below to indicate who will be paying the Registration Fee:

Paid in full from the Driver's personal account

Paid in full by the Entrant on the Driver's behalf

Paid by a business account from a third party (such as a Competitor Sponsor) on the Driver's behalf

 Paid by a family member or other individual on the Driver's behalf

If part or all of the Registration Fee is being paid by anybody or any entity other than the Driver or (if relevant) the Entrant, then that third party must fill in and sign Section 11 below.

SECTION 7: RACE NUMBER REQUEST

Please indicate the three choices, in order, for the Driver's Race Number.

First choice: _____

Second choice: _____

Third choice: _____

SECTION 8: SIGNATURE BLOCK FOR ALL DRIVERS

IMPORTANT: All Drivers must read this section, tick each box to confirm his acceptance of each issue and then sign below. If a Driver is under 18 years of age then a parent or legal guardian must also complete Section 9 below.

I hereby acknowledge and agree to the following in electing to participate in the Championship.

EXECUTION VERSION

I declare that I have been given the opportunity to read, and agree to be bound by, the Motorsport UK Regulations and further confirm that, once I have signed the Acceptance Form, I agree to be bound by the 2024 Regulations.

I understand that motorsport can be dangerous and accidents causing death, injury, disability and property damage can and do happen. I understand that these risks may give rise to my suffering personal injury or other loss and I acknowledge and accept these risks. In consideration of the acceptance of this entry I agree that neither any one of or any combination of Motorsport UK, the Organising Club, Porsche, the Porsche Group, the Track Owners, the other Drivers and the other Entrants and their respective group companies, officers, servants, representatives and agents (the "**Parties**") shall have any liability for loss or damage that may be sustained or incurred by me as a result of participation in the Championship including but not limited to damage to property, economic loss, consequential loss or financial loss howsoever caused. To the fullest extent permitted by applicable law, if acting for purposes relating to my trade, business, craft or profession, I agree to indemnify and hold harmless each of the Parties in respect of any loss or damage arising directly or indirectly from my participation in the Championship or from any breach by me of the terms of this Registration Form (including without limitation providing any false or misleading information), the 2024 Regulations and/or Motorsport UK Regulations. Nothing in this clause is intended to (or shall be deemed to) exclude or limit liability: (i) for death or personal injury caused by the negligence of one or more Parties; or (ii) for any other liability that cannot be excluded or limited under applicable law.

I declare that to the best of my belief I possess the standard of competence necessary for the Championship and that the Car is suitable and roadworthy for the Championship having regard to the Tracks that the Car will be raced on and the speeds that will be reached.

I am a racing member of BARC and am in possession of a valid Motorsport UK Competition Licence Race Club minimum (or equivalent licence issued by Motorsport Ireland or, if the Driver is registered with a different ASN (as defined in the Motorsport UK Regulations), meet the requirements set out in Motorsport UK Regulation H25.2.1 to the satisfaction of BARC) for the Car I intend to drive and will produce it for inspection on demand by Porsche.

I will wear a seatbelt at all times when in the Car.

I shall pay attention to, and comply with, all instructions given to me by the employees and/or agents of Porsche, the Organising Club and/or Motorsport UK prior to each Event, and I am fully familiar with the controls and operation of the Car. Accordingly, if there is any aspect of the controls or operation of the Car with which I am uncertain or unfamiliar, I will not drive the Car until further instruction has been given to me by the employees and/or agents of Porsche, the Organising Club and/or Motorsport UK prior to or during that Event.

I declare that: (i) I am physically and mentally fit to take part in the Championship and I am competent to do so, I acknowledge that I understand the nature and type of the Championship and the potential risk inherent with motorsport and agree to accept that risk; and (ii) my eyesight is up to the standard required for the Championship. I am not suffering from haemophilia and have no history of epilepsy, colour blindness or any other medical condition or disability that is likely to adversely affect my ability to take part in the Championship or my normal control of a vehicle. I will not, at any time during any Event, be under the influence of alcohol and I acknowledge and agree that Porsche may require me to submit a breathalyser test prior to participating in any Event as set out in the 2024 Regulations. I am not, and will not be at any time during any Event, taking any form of medication, drugs or other substances, and I do not know of any other reason, which would restrict me from participating in the Championship and/or impair my driving abilities. If any of the foregoing ceases to be correct, I shall immediately notify Porsche.

I understand that should I, at the time of any Event, be suffering from any disability whether permanent or temporary that is likely to affect prejudicially my normal control of my Car, I may not take part unless I have declared such disability to Motorsport UK which has, following such declaration, issued a licence that permits me to do so.

I have read and fully understood the regulations for Control of Drugs and Alcohol as contained in the Motorsport UK Regulations, in particular C1.1.7, H38, D35.1, G15.1.4 and have also fully familiarised myself with the information on the web sites referred to (www.motorsportuk.org, www.ukad.org.uk and www.wada-ama.org) in particular the UK Anti-Doping Rules, which have been adopted by Motorsport UK.

I hereby agree to abide by the Motorsport UK Safeguarding Policy and Guidelines and the National Sporting Code of Conduct, each as set out in the Motorsport UK Regulations.

I hereby agree that, as of today's date, and on a repeating basis on each day throughout the Championship, I am not a shareholder of any of the following entities: (a) Porsche Automobil Holding SE, including its subsidiaries; (b) Federal State of Lower Saxony & companies in which it has a majority holding; (c) State of Qatar & companies in which it has a majority holding; or (d) Companies and Foundations of the Porsche and Piëch families. I will notify Porsche immediately if I become a shareholder of any

EXECUTION VERSION

of the foregoing entities. Porsche may terminate my registration in the Championship with immediate effect at any time by giving written notice to me if I breach any of the foregoing (or if the Entrant, parent/guardian or third party funder breach the equivalent obligation as set out in Sections 9 to 11 (inclusive) below).

[] I acknowledge that Porsche Cars Great Britain Limited will process the personal data (including without limitation the personal data provided in this form and provided in accordance with Section 6.6 (Use of Entrant Logo and Driver imagery) of the 2024 Regulations) for the purposes of my participation in, and the administration and operation of, the Championship and the purposes set out in Section 6.6 (Use of Entrant Logo and Driver imagery) of the 2024 Regulations. Further details of how Porsche Cars Great Britain Limited may use my personal data are set out in the privacy policy available at <https://www.porsche.com/uk/privacy-policy/>.

Whilst each Driver benefits from the insurance policy taken out by Motorsport UK in accordance with the Motorsport UK Regulations (see Appendix 2 to the Motorsport UK Regulations) for all Rounds, the Driver will not be covered for certain types of losses that he may suffer or certain types of liability that he may incur in his participation in the Championship. Porsche strongly recommends that the Driver takes out his own insurance policies to protect him against: (1) any liability he may incur for personal injury or property damage caused by his negligence whilst on a Track; and (2) any personal injury or property damage he may suffer participating in Test Days.

Future Contact

Porsche Cars Great Britain Limited would like to contact you in future with information about its products, services or events and/or the products, services or events of its group companies or carefully selected commercial partners. If you would like us to send you information about these products, services or events, please tick the appropriate box or boxes below. Ticking the boxes below and consenting to receiving this information is completely optional and you can unsubscribe and withdraw your consent at any time. Please refer to the 'Contact' section at the end of the document for how to do this.

Yes, I would like Porsche Cars Great Britain Limited to send me this information by:

[] Email [] Phone [] Text [] Post

Signed by the Driver: Dated: _____

SECTION 9: SIGNATURE BLOCK FOR PARENT/LEGAL GUARDIAN IF THE DRIVER IS UNDER 18 YEARS OF AGE

IMPORTANT: If the Driver is under 18 years of age, a parent or legal guardian of the Driver must read this section, tick each box to confirm their acceptance of each issue and then sign below. Drivers over 18 years of age do not need to complete this section.

I hereby acknowledge and agree to the following.

[] I declare that to the best of my belief the Driver possesses the standard of competence necessary for the Championship and that the Car entered is suitable and roadworthy for the Championship having regard to the Tracks that the Car will be raced on and the speeds that will be reached.

[] I understand that I shall have the right to be present during any medical procedure being carried out under the 2024 Regulations and the Motorsport UK Regulations. I confirm that I have acquainted myself and the Driver with the Motorsport UK Regulations and the 2024 Regulations, agree to pay any appropriate charges and fees pursuant to the Motorsport UK Regulations and the 2024 Regulations (to include any appendices thereto) and hereby agree to be bound by the Motorsport UK Regulations and the 2024 Regulations and submit myself without reserve to the consequences resulting from the Motorsport UK Regulations and the 2024 Regulations (and any subsequent alteration thereof). Further, I shall use my best endeavours to ensure that the Driver shall adhere to the terms of the Motorsport UK Regulations and the 2024 Regulations (including, but not limited to, the Commercial Regulations) and agree to pay as liquidated damages any fines imposed upon the Driver under the Motorsport UK Regulations and the 2024 Regulations.

[] I have read and fully understood the regulations for Control of Drugs and Alcohol as contained in the Motorsport UK Regulations, in particular C1.1.7, H38, D35.1, G15.1.4 and have also fully familiarised myself with the information on the web sites referred to (www.motorsportuk.org, www.ukad.org.uk and www.wada-ama.org) in particular the UK Anti-Doping Rules, which have been adopted by Motorsport UK. In addition to the deemed consent to the testing of the Driver (2021 UK Anti-Doping Rule 5.7.1) I hereby confirm that I give consent for the Driver to be so tested.

[] I hereby agree to abide by the Motorsport UK Safeguarding Policy and Guidelines and the National Sporting Code of Conduct, each as set out in the Motorsport UK Regulations.

EXECUTION VERSION

I hereby agree that, as of today's date, and on a repeating basis on each day throughout the Championship, I am not a shareholder of any of the following entities: (a) Porsche Automobil Holding SE, including its subsidiaries; (b) Federal State of Lower Saxony & companies in which it has a majority holding; (c) State of Qatar & companies in which it has a majority holding; or (d) Companies and Foundations of the Porsche and Piëch families. I will notify Porsche immediately if I become a shareholder of any of the foregoing entities. Porsche may terminate the Driver's registration in the Championship with immediate effect at any time by giving written notice to the Driver if I breach any of the foregoing.

I acknowledge that Porsche Cars Great Britain Limited will process both my and the Driver's personal data (including without limitation the personal data provided in this form and provided in accordance with Section 6.6 (Use of Entrant Logo and Driver imagery) of the 2024 Regulations) for the purposes of the Driver's participation in, and the administration and operation of, the Championship and the purposes set out in Section 6.6 (Use of Entrant Logo and Driver imagery) of the 2024 Regulations. Further details of how Porsche Cars Great Britain Limited may use the Driver's personal data are set out in the privacy policy available at <https://www.porsche.com/uk/privacy-policy/>.

Future Contact

Porsche Cars Great Britain Limited would like to contact you in future with information about its products, services or events and/or the products, services or events of its group companies or carefully selected commercial partners. If you would like us to send you information about these products, services or events, please tick the appropriate box or boxes below. Ticking the boxes below and consenting to receiving this information is completely optional and you can unsubscribe and withdraw your consent at any time. Please refer to the 'Contact' section at the end of the document for how to do this.

Yes, I would like Porsche Cars Great Britain Limited to send me this information by:

Email Phone Text Post

Signed by the parent/legal guardian: Dated: _____

NB. If this Registration Form is submitted by facsimile or by any other electronic communication, that parent or legal guardian must submit this Registration Form.

SECTION 10: SIGNATURE BLOCK FOR THE ENTRANT

If the Driver represents an Entrant, the Entrant's Entrant Manager must (on behalf of the Entrant) read this section, tick each box to confirm acceptance of each issue and then sign below.

The information provided by the Driver in this Registration Form, to the best of the Entrant's knowledge and after having made reasonable enquiries, is true, accurate and complete.

If any of the information provided in this Registration Form changes or ceases to be accurate during the Season, the Entrant will promptly notify Porsche accordingly.

The Entrant enters the Championship entirely at its own risk and accepts the inherent risks associated with the Championship for the Entrant and each of its employees, agents, directors and consultants (the "**Entrant Members**").

The Entrant holds a valid Motorsport UK National Entrants Licence and will continue to do so throughout the Championship.

The Entrant shall pay attention to all instructions given to any Entrant Member by the employees and/or agents of Porsche, the Organising Club and/or Motorsport UK prior to each Event.

Each Entrant Member is medically both mentally and physically fit to fulfil the role assigned to him in relation to the Championship.

Porsche, the Organising Club, each Track Owner and their respective employees, officers, servants representatives and agents (each, a "**Party**") will not be responsible for any liability, claim, loss, damage, costs or expenses of any kind or nature arising directly or indirectly from the Entrant's participation in the Championship (except for any liability of a Party for death or personal injury caused by any negligence of that Party, its employees or agents). No claim of whatsoever kind shall be made by the Entrant or on the Entrant's behalf against any Party. To the fullest extent permitted by applicable law, the Entrant agrees to indemnify and hold harmless each of the Parties in respect of any loss or damage arising directly or indirectly from the Entrant's participation in the Championship or from any breach by the Entrant of the terms of this Registration Form (including without limitation providing any false or misleading information), the 2024 Regulations and/or the Motorsport UK Regulations. Nothing in this clause is intended to (or shall be deemed to) exclude or limit liability: (i) for death or personal injury caused by the negligence of one or more Parties; or (ii) for any other liability that cannot be excluded or limited under applicable law.

The Entrant holds property insurance and public liability insurance, each in respect of the Entrant's participation in the Championship, and the Entrant will ensure all the conditions of such insurance policies are complied with.

The Entrant has read, and agrees to be bound by, the Motorsport UK Regulations and further confirms that, once the Entrant has signed the Acceptance Form, the Entrant agrees to be bound by the 2024 Regulations.

The Entrant hereby represents, warrants and undertakes that, as of today's date, and on a repeating basis on each day throughout the Championship, it is not a shareholder of any of the following entities: (a) Porsche Automobil Holding SE, including its subsidiaries; (b) Federal State of Lower Saxony & companies in which it has a majority holding; (c) State of Qatar & companies in which it has a majority holding; or (d) Companies and Foundations of the Porsche and Piëch families. The Entrant will notify Porsche immediately if it becomes a shareholder of any of the foregoing entities. Porsche may terminate the Driver and Entrant's registration in the Championship with immediate effect at any time by giving written notice to the Driver and the Entrant if the Entrant breaches any of the foregoing.

The Entrant Manager is authorised to bind the Entrant.

I acknowledge that Porsche Cars Great Britain Limited will process the personal data (including without limitation the personal data provided in this form and provided in accordance with Section 6.6 (Use of Entrant Logo and Driver imagery) of the 2024 Regulations) for the purposes of the Entrant's participation in, and the administration and operation of, the Championship and the purposes set out in Section 6.6 (Use of Entrant Logo and Driver imagery) of the 2024 Regulations. Further details of how Porsche Cars Great Britain Limited may use the Entrant's personal data are set out in the privacy policy available at <https://www.porsche.com/uk/privacy-policy/>.

Future Contact

Porsche Cars Great Britain Limited would like to contact you in future with information about its products, services or events and/or the products, services or events of its group companies or carefully selected commercial partners. If you would like us to send you information about these products, services or events, please tick the appropriate box or boxes below. Ticking the boxes

EXECUTION VERSION

below and consenting to receiving this information is completely optional and you can unsubscribe and withdraw your consent at any time. Please refer to the 'Contact' section at the end of the document for how to do this.

Yes, I would like Porsche Cars Great Britain Limited to send me this information by:

Email Phone Text Post

Signed by the Entrant Manager on behalf of the Entrant:

Signature: Dated: _____

Name: _____

SECTION 11: THIRD PARTY FUNDERS

IMPORTANT: If the Registration Fee is paid by a third party funder (other than the Entrant) on behalf of the Driver, that third party (the "Funder") must read this section, fill in the information where requested and tick each box to confirm its acceptance of each issue and then sign below.

Full name of Funder: _____

Address: _____

Telephone number: _____

If not an individual, type of legal entity (e.g. limited company; limited liability partnership; partnership; unincorporated association etc):

Registered name (if applicable): _____

Registered address (if applicable): _____

Registered number (if applicable): _____

[] The Funder hereby represents, warrants and undertakes that, as of today's date, and on a repeating basis on each day throughout the Championship, it is not a shareholder of any of the following entities: (a) Porsche Automobil Holding SE, including its subsidiaries; (b) Federal State of Lower Saxony & companies in which it has a majority holding; (c) State of Qatar & companies in which it has a majority holding; or (d) Companies and Foundations of the Porsche and Piëch families. The Funder will notify Porsche immediately if it becomes a shareholder of any of the foregoing entities. Porsche may terminate the Driver's registration in the Championship with immediate effect at any time by giving written notice to the Driver if the Funder breaches any of the foregoing.

[] I acknowledge that Porsche Cars Great Britain Limited will process the personal data provided in this form for the purposes of processing the Registration Fee, and the administration and operation of, the Championship. Further details of how Porsche Cars Great Britain Limited may use my personal data are set out in the privacy policy available at <https://www.porsche.com/uk/privacy-policy/>.

[] The signatory below is authorised to bind the Funder.

Future Contact

Porsche Cars Great Britain Limited would like to contact you in future with information about its products, services or events and/or the products, services or events of its group companies or carefully selected commercial partners. If you would like us to send you information about these products, services or events, please tick the appropriate box or boxes below. Ticking the boxes below and consenting to receiving this information is completely optional and you can unsubscribe and withdraw your consent at any time. Please refer to the 'Contact' section at the end of the document for how to do this.

Yes, I would like Porsche Cars Great Britain Limited to send me this information by:

[] Email [] Phone [] Text [] Post

Signed on behalf of the Funder:

Signature: Dated: _____

Full name of signatory: _____

SECTION 12: DISPUTE RESOLUTION

For businesses:

For any party to this Registration Form that is acting for purposes relating to their trade, business, craft or profession, then:

(A) this Registration Form shall be governed by and construed in accordance with English law; and

EXECUTION VERSION

- (B) any dispute (contractual or non-contractual) arising out of or in connection with this Registration Form including any question regarding the existence, validity or termination of this Registration Form shall be submitted to the exclusive jurisdiction of the English courts.

For consumers:

For any party to this Registration Form that is acting for purposes that are wholly or mainly outside its trade, business, craft or profession (the "**Consumer**") then:

- (A) this Registration Form is governed by the laws of England and Wales. This means that any dispute or claim arising out of or in connection with this Registration Form (including non-contractual disputes or claims) will be governed by the laws of England and Wales;
- (B) the Consumer may bring any dispute which may arise under this Registration Form to – at its discretion – either the competent court of England, or to the competent court of its country of habitual residence if this country of habitual residence is within the United Kingdom or an EU Member State, which courts are – with the exclusion of any other court – competent to settle any of such a dispute. Porsche shall bring any dispute which may arise under this Registration Form to the competent court of the Consumer's country of habitual residence if this is within the United Kingdom or an EU Member State or otherwise the competent court of England; and
- (C) if the Consumer is resident in another country within the United Kingdom or an EU Member State and Porsche directs the Championship to (or it otherwise pursues commercial or professional activities related to the Championship in) that country within the United Kingdom or the EU Member State, the Consumer will benefit from any mandatory provisions of the law of that country within the United Kingdom or the EU Member State. Nothing in this Registration Form, including sub-clause (A) above, affects the Consumer's rights as a consumer to rely on such mandatory provisions of local law.

Please return the original form to Ian Fletcher, Porsche Sprint Challenge GB or email a copy to ian.fletcher@porsche.co.uk.

Contact

Your main point of contact for reviewing, amending or discussing your consent preference is the Porsche Customer Assistance Centre, Porsche Cars Great Britain Limited located at Bath Road, Reading, Berkshire, United Kingdom, RG31 7SE. You may contact us by:

- submitting your request to the “General enquiries and comments” section of our Website: <https://www.porsche.com/uk/dialog/contactandinformation/customerservices/>;
- calling us on 08457 911 911; or
- writing to us at the abovementioned address.

Additional information concerning data processing and customisation in the area of the Porsche customer and prospect care by Porsche Cars Great Britain Limited can be found in the Privacy Notice available at <https://www.porsche.com/uk/privacy-policy/>.

THANK YOU FOR REGISTERING FOR THE PORSCHE SPRINT CHALLENGE GB 2024

| |
|---|
| APPENDIX 3: STAFF AND VEHICLE INFORMATION FORM |
|---|

Name of Entrant: _____

Name of Driver: _____

Race transporter details

| | | | |
|---|---|------------------|--------------|
| Registration number | | | |
| Length of vehicle | | Width of vehicle | |
| Length of awning | | Width of awning | |
| Side of awning when the transport is viewed from the rear (please circle) | | | Left / Right |
| Type of vehicle (please circle) | Artic Transporter / Rigid Transporter / Van & Trailer | | |

Motorhome/Caravan details

Any motorhome requiring access to the Motorhome area must be listed on this form. One per registered Driver only.

| | | | |
|------------------------------|--|--|--|
| Registration number | | | |
| Length of vehicle and awning | | | |
| Width of vehicle and awning | | | |

Please make sure your measurements are accurate, the Paddock Team will check dimensions prior to passes being issued.

Porsche Sprint Challenge GB 2024 Race Suit Badge Positioning Guide



Part A: Porsche 718 Cayman GT4 Clubsport (Type 982)**Concept**

1. Single-seater, near-standard production-based race car, not road homologated

Engine

2. Aluminium six-cylinder mid-positioned boxer engine with rigid mounting
3. 3,800 cc; stroke 77.5 mm, bore 102 mm
4. Max. power: 313 kW (425 hp) at 7,500 rpm
5. Max. rpm: 7,800 rpm
6. Max. torque: 425 Nm at 6,600 rpm
7. Compression ratio: 12.5:1
8. Racing optimised water cooling with thermal management for engine and gearbox
9. Four-valve technology with adjustable camshaft phasing and variable valve timing VarioCam Plus
10. Fuel quality: Super Plus unleaded, minimum 98 octane
11. Racing optimised electronic engine management (Continental SDI 9)
12. Integrated dry sump lubrication
13. 100-cell metal catalytic converter complying with DMSB specifications

Transmission

14. Rear wheel drive
15. 6-speed PDK gearbox with rigid suspension and electronic control unit optimised for racing
16. Reinforced dual mass flywheel
17. Internal pressure oil lubrication with active oil cooling
18. Differential lock optimised for racing

Bodywork

19. Lightweight body in aluminium-steel composite construction
20. Welded-in roll-cage, certified according to FIA Art. 277
21. Front bonnet with quick release fasteners
22. Rear hood with quick release fasteners
23. Fixed rear wing with "swan neck" mount made of natural-fibre composite materials, including the sideblades, black aluminium wing supports with integrated carbon fibre Gurney flap
24. Driver and co-driver doors of natural-fibre composite materials
25. Roof including escape hatch, certified according to FIA Art. 275a
26. Recaro race bucket seat with longitudinal adjustment and padding system, adjustable to the individual needs of the drivers (in accordance with FIA Standard 8862/2009 – the latest FIA requirements)
27. Three-piston air jack system
28. Provision for safety net
29. FIA-certified towing loops, front and rear
30. Motorsport centre console with enhanced functionality and adapted usability
31. Six-point safety harness
32. 115-litre FT3 safety fuel cell with "Fuel Cut Off" safety valve complying with FIA regulations

Suspension

33. Front axle:
 - a. MacPherson suspension strut, adjustable in height, camber and track
 - b. Forged suspension links: optimised stiffness, double shear mounting, high-performance spherical bearings
 - c. 5-bolt wheel hubs
 - d. Electromechanical power steering with variable steering ratio
 - e. Anti-roll bar, 3-hole design
34. Rear axle:
 - a. MacPherson suspension strut, adjustable in height, camber and track
 - b. Forged suspension links: optimised stiffness, double shear mounting, high-performance spherical bearings
 - c. 5-bolt wheel hubs

EXECUTION VERSION

- d. Adjustable blade-type anti-roll bar

Brake system

- 35. Front axle:
 - a. Aluminium, mono-bloc six-piston racing callipers with “Anti Knock Back” piston springs
 - b. Steel brake discs, multi-piece, ventilated and grooved, 380 mm diameter
 - c. Racing brake pads
 - d. Brake balance adjustment via a balance bar system
- 36. Rear axle:
 - a. Aluminium, mono-bloc four-piston racing callipers with “Anti Knock Back” piston springs
 - b. Steel brake discs, multi-piece, ventilated and grooved, 380 mm diameter
 - c. Racing brake pads
 - d. Brake balance adjustment via a balance bar system

Electrics

- 37. COSWORTH instrument cluster ICD with integrated data logger
- 38. Upgraded fault diagnosis with PIWIS motorsport tester
- 39. Porsche Track Precision Race App
- 40. Integrated lap trigger via GPS signal
- 41. Electronic throttle system
- 42. Lightweight lithium-ion (LiFePo) battery, 60 Ah, leak-proof, mounted in passenger footwell
- 43. Emergency cut-off switch in cockpit and outside left of the windscreen
- 44. Driving stability system PSM (Porsche Stability Management) with ABS, traction Control (TC) and Electronic Stability Control (ESC), able to be completely deactivated
- 45. Tyre pressure monitoring system (TPMS)
- 46. Central fire extinguishing system in accordance with FIA regulations
- 47. Air conditioning
- 48. Electric wing mirror adjustment
- 49. Multifunctional CFRP motorsport steering wheel with pit speed limiter and quick release coupling
- 50. Centre console with map switch to adjust the ABS, ESC, TC and switch between pre-set tyre circumferences

Weight/dimensions

- 51. Total weight: 1,320 kg
- 52. Total length: 4,456 mm
- 53. Total width: 1,778 mm
- 54. Total height: 1,238 mm
- 55. Wheelbase: 2,456 mm

Rims/Tyres

- 56. Front axle:
 - a. One-piece light-alloy forged wheels in new weight-optimised rim design, 9J x 18 offset 28 with 5-bolt mounting
 - b. Delivered with Michelin transportation tyres, dimension: 25/64-18
 - c. Michelin slick/wet tyres, dimension: 25/64-18
- 57. Rear axle:
 - a. One-piece light-alloy forged wheel in new weight-optimised rim design, 10.5J x 18.5 offset 53 with 5-bolt mounting
 - b. Delivered with Michelin transportation tyres, dimension: 27/68-18
 - c. Michelin slick/wet tyres, dimension: 27/68-18

Colours

- 58. Water-based paint
- 59. Exterior: white C9A
- 60. Interior: white filler-coat, without lacquer

Part B: Porsche 718 Cayman GT4 RS Clubsport (Type 982)

Concept

1. Single-seater, near-series racing car
2. Base: 718 Cayman GT4 RS
3. SRO GT4 homologated

Chassis & brakes

4. McPherson strut, adjustable in height, camber and toe
5. 2-way shock absorber with improved characteristic curve
6. 3 spring rates front axle, 3 spring rates rear axle
7. 5-hole wheel hubs
8. Adjustable sword-type anti-roll bar on front and rear axles
9. Tyre Pressure Monitoring (TPM)
10. Two independent brake circuits, brake balance adjustment via balance beam system
11. Racing-optimised PSM, map switch for setting ABS, ESC and TC
12. Steel brake discs, multi-piece, internally vented and slotted (380 mm diameter)
13. Racing brake pads

Engine

14. Naturally aspirated 6-cylinder boxer engine in mid-engine design with rigid suspension
15. 3,996 cm³; stroke 81.5 mm; bore 102 mm
16. Power: max. 368 kW (500 PS)
17. Fuel quality: at least 98 octane, unleaded
18. Metal catalytic converter according to SRO specification (quiet exhaust system available in After Sales)
19. BOP mapping with restrictor apertures

Power transmission

20. 7-speed PDK transmission with rigid suspension
21. Short gear ratio (in comparison with the 718 Cayman GT4 Clubsport)
22. Rear-wheel drive
23. Dual-mass flywheel
24. Internal pressure-oil lubrication with active oil cooling
25. Mechanical differential lock, optimised for racing
26. Shift paddles on steering wheel

Electrics

27. COSWORTH ICD instrument cluster with integrated data logger
28. Additional CAN data logger
29. Advanced fault diagnosis through PIWIS Motorsport tester
30. Track Precision app
31. Bi-xenon main headlights, LED tail lights
32. Motorsport multifunction steering wheel with optimised functionality (FCY function) made of natural fibre composite material
33. Lightweight lithium-ion battery (LiFePo)
34. Air conditioner
35. Rain light according to FIA regulations
36. Central fire extinguishing system according to FIA regulations

Body

37. Lightweight body in intelligent aluminium-steel Composite construction
38. Welded-in roll cage with new geometry for taxi rides, according to FIA regulation for safety cages
39. Natural fibre composite body panels (doors, Front lid, front wings, add-on parts and rear wings)
40. Roof with escape hatch, certified according to FIA Art. 275a

EXECUTION VERSION

41. Recaro racing bucket seat with fore/aft adjustment, according to FIA regulation, padding system for individual adjustment to the driver
42. 6-point harness in accordance with the FIA standard for 2023 for driver seats
43. 115-litre FT3 safety tank with "fuel cut-off" Safety valve according to FIA regulations
44. Quick-release fasteners on the front and rear lid
45. 3-piston air lifting unit
46. Safety nets
47. FIA certified towing loops at front and rear
48. Optimised aerodynamics (flics, gurney, air curtain, wheel housing vents, larger adjustment range for rear wings)
49. Attractive interior
50. Optimised brake cooling (via Nacas on the front lid and modified air supply on wishbone)
51. Safety foam in the driver's door according to FIA regulation Electrics

Weight & Dimensions

52. Homologated unladen vehicle weight: 1,330 kg
53. Width: 1,810 mm
54. Length: 4,450 mm
55. Height: 1,238 mm
56. Wheelbase: 2,476 mm

Rims & Tyres

57. One-piece forged light alloy rims with 5-hole connection
58. Front axle 9J x 18
59. Rear axle 10.35J x 18
60. Delivery on Michelin transport tyres

Colour

61. Exterior: White (C9A)
62. Interior: Filler colour in white, without clear coat

PORSCHE



SPRINT CHALLENGE
GREAT BRITAIN

APPENDIX 7: INDEMNITY FORM FOR DRIVER COACHES

PARTICIPATION FORM – DRIVER COACH

This form sets out the obligations of the Driver Coach in relation to the Porsche Sprint Challenge GB event at the Circuit (in each case, as defined below) (the "**Event**"). The Driver Coach should read, fill in and sign below.

Please provide the following details:

Event: _____

Name of Driver Coach: _____ (the "**Driver Coach**")

Address: _____

Telephone no: _____

Date of birth: _____

Please read the below and then sign to confirm your acceptance of each issue. Defined terms used in this form have the meaning given to them in the regulations issued by Porsche in relation to the Championship.

I declare that I have been given the opportunity to read, and agree to be bound by, the Motorsport UK Regulations and the Regulations. I declare that I am physically and mentally fit to take part in the Event and I am competent to do so, I acknowledge that I understand the nature and type of the Event and the potential risk inherent with motor sport and agree to accept that risk.

I agree to comply with all instructions given to me by (or on behalf of) Porsche in relation to the Event, including all rules relating to the Track issued by the Track Operator.

I agree to attend the Drivers' briefing organised by Porsche in advance of driving on the Track.

I understand that motorsport can be dangerous and accidents causing death, injury, disability and property damage can and do happen. I understand that these risks may give rise to my suffering personal injury or other loss and I acknowledge and accept these risks. In consideration of the acceptance of my participation in the Event I agree that neither any one of or any combination of Porsche, a member of Porsche's group, the relevant Track Operator, TOCA, the Driver, the Entrant, the other drivers and entrants and the other teams and their respective officers, servants, representatives and agents (the "**Parties**") shall have any liability for loss or damage which may be sustained or incurred by me as a result of participation in the Event including but not limited to damage to property, economic loss, consequential loss or financial loss howsoever caused. To the fullest extent permitted by applicable law, I agree to indemnify and hold harmless each of the Parties in respect of any loss or damage arising directly or indirectly from my participation in the Championship or from any breach by me of the terms of this participation form. Nothing in this clause is intended to (or shall be deemed to) exclude or limit liability: (i) for death or personal injury caused by the negligence of one or more Parties; or (ii) for any other liability that cannot be excluded or limited under applicable law.

I shall at all times during the Event use all reasonable skill and care when in the Car and will not encourage or, to the extent of my control, permit the Driver to drive recklessly or dangerously.

I hold all driving licences necessary to participate in the Event, including a valid Motorsport UK Competition Licence (Racing) National B minimum or equivalent Licence issued by Motorsport Ireland (or, if the Driver is registered with a different ASN, meet the requirements set out in Motorsport UK Regulation H25.2.1 to the satisfaction of Porsche). I will produce the relevant licence(s) for inspection on demand by Porsche.

I will wear a seatbelt at all times when in the Car.

I acknowledge and agree that Porsche may arrange for audio, visual and/or audio-visual footage to be taken of the Event and that I may appear in such footage. I agree that Porsche may use (and/or license others – such as commercial partners of Porsche related to the Porsche Sprint Challenge (the "**Commercial Partners**") – to use) such footage (which may also include my name and voice) in (and in connection with) the transmission (via any medium) of coverage of the Event (including through Event official and other communications equipment and microphones), as well as in advertising and promotional material relating to the Event or current or future Porsche Sprint Challenges or other racing championships administered by Porsche (such as, without limitation, media guide covers, programme covers, stadium dressing, television promotions, posters and advertising), and/or in advertising and promotional material produced by or on behalf of the Commercial Partners from time to time to promote their association with the Porsche Sprint Challenge or future championships administered by Porsche, in each case without charge; provided always that no such use shall suggest individual endorsement by me of the products or services of any such Commercial Partners.

Porsche strongly recommends that you read in detail the Motorsport UK insurance policy (see Appendix 2 to the Motorsport UK Regulations) and take out your own insurance policies to protect you against: (1) any liability you may incur for personal injury or property damage caused by your negligence whilst participating in the Event; and (2) any personal injury or property damage that you may suffer from participating in the Event.

I acknowledge that Porsche Cars Great Britain Limited will collect and use the personal data provided in this form for the purposes of my participation as a Driver Coach during the Event. Further details of how Porsche Cars Great Britain Limited may use my personal data are set out in the privacy policy available at <https://www.porsche.com/uk/privacy-policy/>.

Future Contact

Porsche Cars Great Britain Limited would like to contact you in future with information about its products, services or events and/or the products, services or events of its group companies or carefully selected commercial partners. If you would like us to send you information about these products, services or events, please tick the appropriate box or boxes below. Ticking the boxes below and consenting to receiving this information is completely optional and you can unsubscribe and withdraw your consent at any time. Your main point of contact for reviewing, amending or discussing your consent preference is Ian Fletcher via telephone at 01189 165012, by email at porschemotorsportgb@porsche.co.uk, or by post at Porsche Motorsport Dept, Porsche Cars GB, Bath Road, Calcot, Berkshire, RG31 7SE.

Yes, I would like Porsche Cars Great Britain Limited to send me this information by:

Email Phone Text Post

Signed by the Driver Coach: Dated: _____ 2024

APPENDIX 8: SOCIAL MEDIA POLICY

Porsche acknowledges that social media is an important form of communication for many Drivers and Entrants and provides an excellent opportunity to engage with fans. Use of social media can, however, also create risk to the reputation of Drivers, Entrants, Porsche, TOCA, the Championship and the Organising Club. In addition, use of social media also can risk the confidentiality of information. Therefore, in addition to the obligations set out elsewhere in these Regulations, Porsche requires each Driver and each Entrant to abide by this Social Media Policy in all uses of any Social Media Platform to ensure the appropriate, responsible and professional use of social media in relation to the Championship.

1. This policy applies to the use of all Social Media Platforms by Drivers, Entrants and any person or entity acting on their behalf (including employees (direct or indirect), directors, consultants, mechanics, agents or other third parties).
2. To the extent Porsche has an official Championship account on a Social Media Platform, Porsche encourages each Entrant and Driver to link its/their account on that Social Media Platform to such official account.
3. Each Driver and Entrant represents, warrants and undertakes that:
 - (a) they/it will not use any Social Media Platform in a way that:
 - (i) breaches any obligations of confidentiality owed to the Porsche, the Porsche Group, any Broadcaster, the Organising Club, TOCA, any Track Operator, Motorsport UK, the FIA, any Official or any other Entrant or Driver or any of the foregoing's employees (direct or indirect), directors, consultants, mechanics or agents (the "**Stakeholders**" and each, a "**Stakeholder**");
 - (ii) breaches these Regulations, the Motorsport UK Regulations or the FIA Regulations;
 - (iii) is likely to bring any Stakeholder into disrepute;
 - (iv) is likely to cause any Stakeholder to breach these Regulations, the Motorsport UK Regulations or the FIA Regulations;
 - (v) is likely to cause damage to the reputation of any Stakeholder;
 - (vi) is likely to cause financial liability to any Stakeholder;
 - (vii) unlawfully discriminates against, harasses or victimises any third party, or is defamatory, obscene or offensive;
 - (viii) (unless expressly authorised in advance in writing by the Championship Coordinator) implies that it/they are representing the views of Porsche; and/or
 - (ix) criticises, questions or denigrates any decision made by an Official or the performance of any other Driver or Entrant;
 - (b) it/they will not post or otherwise communicate any audio, visual or audio-visual content related to the Championship, save as permitted in Sections 6.9, 6.10 and 6.11;
 - (c) when using any Social Media Platform, it/they will have regard at all times to the requirement to project a positive image of the Championship and Porsche; and

- (d) it/they will comply with the reasonable instructions of the Championship Coordinator regarding the use of any Social Media Platform in relation to the Championship (including, without limitation, any instructions to amend and/or remove any communication or similar).
- 4. In addition to any other remedies for breach of the Commercial Regulations, the Championship Coordinator may require the Entrant or Driver to amend and/or remove any communication or similar that is in breach of this Social Media Policy.
- 5. Any queries relating to this Social Media Policy should be addressed to the Championship Coordinator.

| |
|----------------------------------|
| APPENDIX 9: CONTACT SHEET |
|----------------------------------|

1. The Championship Coordinator

FAO: Championship Coordinator, Ian Fletcher
Porsche Cars Great Britain Limited
Porsche Sprint Challenge GB
Bath Road
Calcot
Reading RG31 7SE

Mobile: 07876 254244

Email: ian.fletcher@porsche.co.uk

2. Motorsport Manager

FAO: Porsche Cars GB Limited Motorsport Manager and Championship Coordinator, James MacNaughton
Porsche Cars Great Britain Limited
Porsche Carrera Cup
Bath Road
Calcot
Reading RG31 7SE
Mobile: 07771 883753
Email: james.macnaughton@porsche.co.uk

3. The Event Planner

FAO: Porsche Cars GB Limited Motorsport Event Planner, Annabel Edmed
Porsche Cars Great Britain Limited
Porsche Sprint Challenge GB
Bath Road
Calcot
Reading RG31 7SE
Mobile: 07823 534368
Email: annabel.edmed@porsche.co.uk

4. The Medical Advisor

FAO: Dr Paul J. Trafford
Mobile: 07785 557470
Email: paul@doctr Traff.co.uk

5. Other contact details

Motorsport UK
141 Command Works
Bicester Motion
Bicester
Oxfordshire OX27 8FY
Telephone: 01753 765000

For technical questions in relation to the Championships:

FAO: Technical Manager, Motorsport, Eddie Corr
Porsche Cars Great Britain Limited
Porsche Sprint Challenge GB
Bath Road
Calcot

Reading, RG31 7SE
Mobile: 07471 147672
[Email: eddie.corr@partner.porschereading.co.uk](mailto:eddie.corr@partner.porschereading.co.uk)

For media questions in relation to the Championships:

FAO: Porsche Cars GB Limited Motorsport Press Coordinator
Porsche Cars Great Britain Limited
Porsche Sprint Challenge GB
Bath Road
Calcot
Reading RG31 7SE
Telephone: 01189 252855
Mobile: 07500 578805
Email: james.lewis-barned@porsche.co.uk

6. The circuits

Snetterton Circuit
Norwich
Norfolk
NR16 2JU
Telephone: 01953 887303

Brands Hatch
Motor Sport Vision
Brands Hatch Circuit
Fawkham
Longfield
Kent DA3 8NG
Telephone: 01474 872331

Silverstone Circuit
Towcester
Northants NN12 8TN
Telephone: 01327 857271

Oulton Park Circuit
Little Budworth
Tarpurley
Cheshire CW6 9BW
Telephone: 01829 760301

Donington Park
Castle Donington
Derby DE74 2RP
Telephone: 01332 810048

Croft Circuit
West Lane
Dolton On Tees
North Yorkshire DL2 2PL
Telephone: 01325 721815



A socially-minded standard of behaviour is expected from everyone within the motorsport community.

By participating in a Motorsport UK event in any capacity you agree to follow the values of the Respect Code:

Motorsportuk.org/racewithrespect
#RaceWithRespect

The Values

- i. Respect
- ii. Fair play
- iii. Integrity
- iv. Good Manners
- v. Self-Control

I pledge to #RaceWithRespect and:

- i. Contribute to a welcoming and friendly environment that ensures the safety and welfare of all participants.
- ii. Always behave with integrity and uphold fairness in the sport; play my part in keeping the sport safe through my actions
- iii. Treat everyone with respect, regardless of their gender, ethnic or social background, language, religious or other beliefs, disability, sexual identity or other status
- iv. Recognise that we all represent the sport and therefore have a duty to be polite and respectful to all staff, officials, fellow competitors, volunteers, as well as fans and supporters
- v. Respect the rules, regulations and authority of the officials and Motorsport UK
- vi. Any breach of these obligations may result in disciplinary action.

APPENDIX 11: SAFETY SELF-DECLARATION FORM



Vehicle Check list - Race Events

| | | | |
|-------------|--|--------------------------------|--|
| Driver name | | Fuel tank: expiry date | |
| Team name | | Seat: expiry date | |
| Car # | | Seat belt: expiry date | |
| Chassis # | | Fire Extinguisher: expiry date | |
| Cage # | | | |
| Fuel Tank # | | | |

| Section | Item Inspected | Checked by - Init | Date |
|-------------------------|---|-------------------|------|
| Chassis | FIA homologated monocoque chassis with no splits , cracks or damage | | |
| Roll cage | Certificated specifically designed cage with no modification or damage. FIA approved padding fitted. | | |
| Fuel tank | FIA homologated FT3 foam filled tank. Cut off valve must be operational. | | |
| Brakes | Brake master cyfnder fluid levels checked. Brake bias mechanism must be free moving. | | |
| Seat | Recaro homologated seat securly fitted with no damage. Seat slide adjustment operational. | | |
| Seat Insert (if fitted) | Correct type and material with no external markings. | | |
| Seat belts | Scroth 5-point homologated belts mounted as set out in the Porsche Technical Manual. In good condition and within date. | | |
| Steering wheel | Original multi-function steering wheel with fully operational quick release mechanism. | | |
| | | | |

| Section | Item Inspected | Checked by - Init | Date |
|--------------------|--|-------------------|------|
| Electrical cut out | Functional internal and externally operated cut out switch. Marked with Porsche supplied FIA symbol. | | |
| Fire Extinguisher | FEV electrically triggered fire extinguisher. Within date and battery tested. External trigger point marked with Porsche supplied FIA 'E' Symbol | | |
| Driver extraction | K.E.D. hatch fixings and hatch perimeter must not be covered. | | |
| Lighting/wipers | Windscreen wiper and all lights fully functional including FIA approved Rain light | | |
| Vehicle recovery | Front and rear towing straps fitted and in good condition. | | |
| Bodywork | Front cover and rear engine cover lock pins in good condition. Car Door hinge pins fitted. Fixing bolts in place. | | |
| Driver aids | 1 internal rear view mirror and 2 door mirrors securely fitted. Air conditioning system gassed and fully functional | | |
| Ballast Weights | Positioned on passenger floor using Porsche approved fixings with cover. | | |
| Battery | Battery located and fixed to passenger footwell and covered | | |
| Race Numbers | Door numbers as per MSUK Regulation. Number shown on windscreen and rear window. | | |
| Driver's apparel | All in accordance with 5.2.5 of the Porsche Sprint Challenge GB regulations. | | |

I declare that the above detailed vehicle and Driver's apparel has been checked against the standard set by the Porsche Sprint Challenge GB regulations which is compliant with all the relevant Motorsport UK Yearbook references in sections J, K & Q and is in compliance. The presentation of this car to scrutineering will be considered as an implicit declaration of conformity. I understand that if it is found that the car does not comply that a penalty may be imposed.

| | |
|-----------------------|-------------------------------|
| Name: | |
| Delete as appropriate | Driver/ Entrant/ Team manager |

| |
|------------|
| Signature: |
| Date: |

APPENDIX 12: PORSCHE SPRINT CHALLENGE 2024 MEDICAL FORM

Each Driver (referred to as "you" and "your" in this form) must submit a completed version of this Medical Form in accordance with Section 1.4.1 of the Championship Regulations.

This information will be treated in strict confidence and will only be used in the event of an accident or injury when appropriate details may be released to another doctor if necessary.

If you wish to discuss anything related to this Medical Form please contact Dr Paul Trafford. Their contact details are as follows:

Dr Paul J. Trafford
7 Victoria Circus
Dowanhill
Glasgow G12 9LB

Mobile number: 07785 557470
Email address: paul@doctr Raff.co.uk

It is in your own interests to complete the medical forms below accurately with as much detail as possible. If you do not have enough space to include the relevant information, please use the continuation sheet at the back of this Medical Form.

Once completed, please return this form to Dr Paul Trafford directly.

Name of Driver: _____

General Practitioner

Name: _____

Address: _____

Telephone no: _____

Driver information

1. Weight: _____ Kg. or St.Lb.
2. Height: _____ Cm. or Ft.In.
3. Blood Group (if known): _____
4. Right or left handed: _____
5. Do You Wear Contact Lenses? Yes / No
If so are they hard or soft? Hard / Soft
6. Do you smoke? Yes / No
If so how many a day? _____

7. Do you take any drugs prescribed by your doctor? Yes / No
If so please list: _____
8. Do you take any drugs bought by yourself from a pharmacy? Yes / No
If so please list: _____
9. Have you ever taken steroids (prednisolone/hydrocortisone)? Yes / No
If so please list with dates: _____
10. Are you allergic to anything (e.g. penicillin / iodine)? Yes / No
If so please list: _____
11. Have you ever suffered from concussion following an accident? Yes / No
If so please state how many times and date of last concussion:

12. Have you ever had any operations? Yes / No
If so please state what for and dates:
Operation: _____ Date: _____
Operation: _____ Date: _____
Operation: _____ Date: _____
13. If you have had any anaesthetics were there any problems? Yes / No
If there were please state what: _____
14. Have you been in hospital as a patient other than for an operation?
Yes / No
If so for what: _____
15. Do you have any neck/back problems or have you had any neck/back injuries? Yes / No
If so please list: _____
16. Have you broken any bones (e.g. wrist)? Yes / No
If so please list: _____
17. Do you have any false teeth/caps/crowns? Yes / No
If so please list: _____
18. Have you had an anti-tetanus injection? Yes / No
If so please list the years: _____
19. Do you have any private medical insurance? Yes / No
If so, please state the company and policy number: _____

In the event of an injury, if you wish to use any private insurance, please be aware that not all policies will cover emergency treatment in hospital. It is worth checking the terms of your policy.

20. Is there anything else you think is relevant or important in your medical history? Yes / No
If so, please explain here:

Medical Form declaration

I understand that the above medical information will remain confidential and only be released to another doctor if considered necessary. I also agree to information from another doctor / hospital being released to Dr Paul J. Trafford in the event of an accident or injury.

Driver's signature:

Dated: _____

(Please print and sign this form (do not type your name electronically))

Drivers under 18 years old

If the Driver is under 18 years of age, please state their age: _____

If the Driver is under 18 years of age, this Medical Form must be countersigned by that Driver's parent or legal guardian whose full name and address shall be given below:

Signature of parent/legal guardian:

Dated: _____

Name: _____

Address: _____

APPENDIX 13: TESTING FORM

Name of Driver: _____

Championship Race Number: _____

Car Chassis Number: WPO ZZZ _____

Name of Entrant: _____

Location of Test Day: _____

Date of Test Day: ____/____/ 2024

Any Other Registered Drivers Present? (But Not Testing)

| | |
|-------|-------|
| _____ | _____ |
| _____ | _____ |
| _____ | _____ |

Driver / Entrant Manager

Authorised by (Office Use Only)

Name: _____

Name: _____

Signature: _____

Position: _____

Date: _____

Signature: _____

Date: _____

APPENDIX 14 GLOSSARY OF TERMS

1. In these Regulations, unless the context otherwise requires, the following terms shall have the following meanings:

"Amateur Category" means each of: (i) the Amateur – RS Clubsport Category; and (ii) the Amateur – Clubsport Category;

"Amateur – Clubsport Category" means the Amateur Category for Drivers using a 718 Cayman GT4 Clubsport (Type 982) Car;

"Amateur – RS Clubsport Category" means the Amateur Category for Drivers using a 718 Cayman GT4 RS Clubsport (Type 982) Car;

"Amateur Points" has the meaning given to it in Section 1.13.5;

"ASN" has the meaning given to it in the Motorsport UK Regulations;

"BARC" means the British Automobile Racing Club;

"Broadcast Footage" means the audio, visual and audio-visual footage produced by a Broadcaster in relation to a Meeting;

"Broadcaster" means each official broadcaster of a Round as appointed by (or on behalf of) the Organising Club for that Meeting and/or Porsche;

"Broadcaster Camera" has the meaning given to it in Section 5.22.1(A) Part A or Part B (as applicable);

"BTCC" means the British Touring Car Championship, organised and administered by TOCA;

"Bulletin" means a bulletin issued by the Championship Coordinator and/or the Organising Club to all Drivers and Entrants relating either to the Championship and/or a particular Event;

"Camera" has the meaning given to it in Section 5.22.1 Part A or Part B (as applicable);

"Car" means the vehicle registered to an Entrant as set out in the relevant Registration Form according to the chassis number for that vehicle to be raced in the Championship and that satisfies the conditions set out in Section 1.10 and **"Cars"** shall be construed accordingly;

"Category" has the meaning given to it in Section 1.7.1;

"Category Points" means, for a Driver, the Professional Points or the Amateur Points, relevant to that Driver's Category;

"Championship" means the Porsche Sprint Challenge Great Britain taking place during 2024 in accordance with these Regulations, including all Events, the End of Season Awards and all other events organised by (or on behalf of) Porsche in relation to an Event;

"Championship Coordinator" means a representative of Porsche, the identity of whom is set out in Section 1.3.1 as amended pursuant to Section 1.3.4;

"Championship Launch Day" means the day arranged by Porsche in the weeks prior to the first Meeting for the purposes of allowing each Driver to test their Car and for Commercial Partners and the media to have access to the Drivers and the Entrants;

"Championship Logo" means the logo identified at Appendix 6 or such other logo or logos as Porsche may advise the Entrants and Drivers from time to time;

"Championship Marks" means the marks, logos and title of the Championship, including the Championship Logo and the logos of any Commercial Partner;

"Championship Points" has the meaning given to it in Section 1.13.8, and **"Championship Point"** shall be construed accordingly;

"Championship Regulations" means the regulations herein titled "Championship Regulations", including all Appendices, as may be amended, varied or added to by Porsche from time to time in accordance with Section 1.2.4;

"Championship Steward" means a steward appointed for the Championship in accordance with Motorsport UK Regulation G2.7 and **"Championship Stewards"** shall be construed accordingly. The identities of the Championship Stewards are set out in Section 1.3.1 and may be amended pursuant to Section 1.3.4;

"Clerk of the Course" means a representative of BARC, the identity of whom is set out in Section 1.3.1 as amended pursuant to Section 1.3.4;

"Clubsport Category" means each of: (i) the Amateur – Clubsport Category; and (ii) the Professional – Clubsport Category;

"Clubsport Championship" means the Entrants championship set out further in Sections 1.13.8 and 1.13.9 for Cars that compete in a Clubsport Category;

"Commercial Partner" means any sponsor or other commercial partner of Porsche in relation to the Championship and **"Commercial Partners"** shall be construed accordingly;

"Commercial Regulations" mean the Regulations set out in Section 6;

"Commercial Rights" means all commercial rights in and to the Championship, including:

- (A) the right for entities to advertise their brands, products and services in relation to the Championship, whether at a Track or otherwise by any means;
- (B) all rights relating to the licensing and merchandising of the Championship Marks;
- (C) the right to attend at and to film and/or record and transmit, anywhere in the world, audio and audio-visual signals of Events and other Championship-related content, in whole or in part, whether live or delayed, by all methods of communication to the public by way of electronic transmission (whether analogue or digital or otherwise) now existing or as may be developed in the future, including satellite, cable and terrestrial television and radio, internet, mobile and/or wireless telephony and other technologies (eg, WAP technology, SAS, ADSL, SDL, 3G), interactive technology and fixed media (eg, videos, DVDs, CD-Roms and computer games);
- (D) the right to use words, in connection with the Championship Marks or otherwise, that state or imply approval by or in connection with the Championship or Porsche, such as "Official Sponsor of the Porsche Sprint Challenge" or equivalent;
- (E) the right to an association with the Championship by any combination of commercial rights;
- (F) the right to issue and sell admission tickets for Events, either alone or packaged with corporate hospitality and/or travel arrangements;
- (G) the right to exploit commercially any data generated by the Data System installed in each Car in relation to each Event, provided to Porsche by each Driver under Section 5.21.2 Part A or Part B (as applicable);

- (H) the right to exploit commercially any data generated by the Video Data Logger installed in each Car in relation to each Event, provided to Porsche under Section 5.22 Part A or Part B (as applicable);
- (I) the right to exploit commercially any personal data collected in relation to any marketing or promotional activities undertaken by (or on behalf of) Porsche in relation to the Championship;
- (J) the right to exploit commercially all results and times of each Driver from each Event, including lap times, race times and the leader-board for each Category from time to time;
- (K) the right to exploit commercially the fixture list for each Round; and
- (L) any other rights of any nature whatsoever that are capable of commercial protection and exploitation;

"Competitor Sponsor" has the meaning given to it in Section 6.8.1;

"Confidential Information" means any information in any medium or format (written, oral, visual or electronic), that relates directly or indirectly to the Championship, that is directly or indirectly disclosed to a Driver or Entrant in the course of the Championship that:

- (A) is made clear to the recipient Driver or Entrant that it should be treated confidentially; and/or
- (B) should, by its nature, be obvious to the recipient Driver or Entrant that it should be treated confidentially;

"Contact Sheet" means the contact details set out in Appendix 9;

"Court" has the meaning given to it in Section 2.2.2;

"Data System" means the factory-fitted data recording system manufactured by Cosworth and supplied by Porsche to each Driver;

"Driver" means each driver registered to compete in the Championship in accordance with Section 1.4.10 and **"Drivers"** shall be construed accordingly. For the avoidance of doubt: (A) a Driver is a "Competitor" for the purposes of the Motorsport UK General Regulations; and (B) a Guest Driver shall not be a Driver for the purposes of these Regulations;

"Drivers' Briefing" means a briefing by the Championship Coordinator and/or the Clerk of the Course to all Drivers participating in a particular Meeting;

"Eligibility Scrutineer" means the person designated as the "Eligibility Scrutineer" pursuant to Section 1.3.1 (as amended pursuant to Section 1.3.4);

"Eligibility Scrutineering" means the scrutineering undertaken at each Friday Free Practice and/or Meeting for the purposes of determining whether Cars comply with the Technical Regulations;

"End of Season Awards" means the awards event organised by Porsche following the final Meeting;

"Entrant" means each team registered to compete in the Championship in accordance with these Regulations holding a Motorsport UK Entrants Licence and **"Entrants"** shall be construed accordingly;

"Entrant Logo" means the logo(s), mark(s) and identifier(s) of each Entrant;

"**Entrant Manager**" means the manager of each Entrant from time to time and "**Entrant Managers**" shall be construed accordingly;

"**Entrant Points**" has the meaning given to it in Section 1.13.9;

"**Event**" means each Friday Free Practice, Qualifying Session, Round and Porsche Test Day and "**Events**" shall be construed accordingly;

"**Excluded Category**" means each of the following brand categories:

- (A) tyres;
- (B) petrol, diesel and/or oil; and
- (C) car manufacturers;

"**Fail**" has the meaning given to it in Section 3.20.4;

"**FIA**" means the Fédération Internationale de l'Automobile or its successor from time to time;

"**FIA Regulations**" means the regulations and standards issued by the FIA applicable to the Championship from time to time (including the International Sporting Code);

"**Formation Lap**" means the lap prior the Green Flag Lap when the Drivers leave the assembly area to form the grid for a Round;

"**Friday Free Practice**" means each test day on a Friday (or other date as notified in a Bulletin) prior to Meetings and "**Friday Free Practices**" shall be construed accordingly;

"**Funder**" means any third party (other than an Entrant) that pays the Registration Fee on behalf of a Driver;

"**Green Flag Lap**" means the lap(s) following the Formation Lap prior to a Round for the Drivers to warm up for that Round;

"**Guest Driver**" has the meaning given to it in Section 1.9.3 and "**Guest Drivers**" shall be construed accordingly;

"**Indemnity Form**" means the form for driver coaches set out in Appendix 7;

"**Judge of Fact**" has the meaning given to it in Motorsport UK Regulation G10;

"**International Sporting Code**" means the International Sporting Code issued by the FIA;

"**Marshal**" means a representative of Motorsport UK acting as a marshal of each Round and Qualifying Session and "**Marshals**" shall be construed accordingly;

"**Medical Adviser**" means the medical adviser for the Championship, the identity of whom is set out in Section 1.3.1 as amended pursuant to Section 1.3.4;

"**Medical Form**" means the form set out in Appendix 12;

"**Meeting**" means a weekend comprising of one or more Rounds and a Qualifying Session at a Track as part of the Championship and "**Meetings**" shall be construed accordingly;

"**Module**" has the meaning given to it in Section 3.18.1 and "**Modules**" shall be construed accordingly;

"**Motorsport UK**" means the national membership organisation and governing body for four-wheel motorsport in the United Kingdom;

"**Motorsport UK Regulations**" has the meaning given to it in Section 1.2.1;

"**Officials**" means the positions listed in Section 1.3.1 and the Judges of Fact for each Meeting notified to Drivers and Entrants in accordance with Section 1.3.2 and "**Official**" shall be construed accordingly;

"**Online Test**" means an online test set by (or on behalf of) Porsche from time to time to test Drivers and Entrant Managers understanding of the Motorsport UK Regulations and these Regulations;

"**Organising Club**" means BARC;

"**Other Test Day**" means any day on which a Driver can test a Car on a track other than Friday Free Practices and Porsche Test Days and "**Other Test Days**" shall be construed accordingly;

"**Paddock**" means an area at each Track for the parking of Cars and support vehicles, and for the purpose of servicing Cars;

"**Panel**" has the meaning given to it in Section 1.8.3;

"**Parc Fermé**" means a secure identified area at each Track and into which any Driver must place their Car and/or associated items when directed by Porsche and/or the Organising Club;

"**Parc Fermé Conditions**" has the meaning given to it in Section 3.15.9;

"**Passes**" has the meaning given to it in Section 6.14.1, and "**Pass**" shall be construed accordingly;

"**Passholder**" means, for Friday Free Practices and Meetings, a member of an Entrant provided with a Pass for that Friday Free Practice and Meeting by the relevant Entrant Manager pursuant to Section 6.14 and "**Passholders**" shall be construed accordingly;

"**Pit Lane**" means a part of the Track that provides Cars with access to and from the Pits and "**Pit Lanes**" shall be construed accordingly;

"**Pits**" means an area that may be provided for Drivers, Entrants and their authorised personnel at a Track, for the purpose of servicing Cars and that has direct access to the Pit Lane;

"**Points**" means, for a Driver, Championship Points and/or Category Points, as relevant for that Driver's Category;

"**Porsche**" means Porsche Cars Great Britain Limited;

"**Porsche Commercial Rights**" has the meaning given to it in Section 6.2.2;

"**Porsche Group**" means any company that is, or is a subsidiary of, the ultimate holding company of Porsche from time to time. A "**subsidiary**" or "**holding company**" is to be construed in accordance with section 1159 and schedule 6 of the Companies Act 2006;

"**Porsche Test Day**" means any test day (other than a Friday Free Practice) organised by Porsche (including the Championship Launch Day) on which a Driver can test a Car on a track on and from the date of the Championship Launch Day to (and including) the date of the End of Season Awards;

"**Post-qualification Scrutineering**" has the meaning given to it in Section 4.1.2(B);

"**Post-Round Scrutineering**" has the meaning given to it in Section 4.1.2(B);

"**Previously Declared Tyre**" means a tyre that has been declared as new from the Driver's allocation and used during a Friday Free Practice, Qualifying Session or Round and "**Previously Declared Tyres**" shall be construed accordingly;

"**Professional Category**" means each of: (i) the Professional – RS Clubsport Category; and (ii) the Professional – Clubsport Category;

"**Professional – Clubsport Category**" means the Professional Category for Drivers using a 718 Cayman GT4 Clubsport (Type 982) Car;

"**Professional – RS Clubsport Category**" means the Professional Category for Drivers using a 718 Cayman GT4 RS Clubsport (Type 982) Car;

"**Professional Points**" has the meaning given to it in Section 1.13.2;

"**Qualifying Session**" has the meaning given to it in Section 3.4.1;

"**Racelink Receiver**" has the meaning given to it in Section 5.27.1 Part A or Part B (as applicable); and

"**Race Number**" means the number issued by Porsche to each Driver as an identifier for the Championship and "**Race Numbers**" shall be construed accordingly;

"**Race Procedures**" mean the regulations set out in Section 3;

"**Race Suit**" has the meaning given to it in Section 6.3.3 and "**Race Suits**" shall be construed accordingly;

"**Registration Fee**" means the amount payable by (or on behalf of) a Driver to register for the Championship as set out in Section 1.4.4;

"**Registration Form**" means the form set out in Appendix 2 and "**Registration Forms**" shall be construed accordingly;

"**Regulations**" means the regulations set out herein, including the mission statement and code of conduct set out at the front and these Championship Regulations;

"**Regulatory Body**" means the appropriate regional office of OFCOM;

"**Reserved Rights**" has the meaning given to it in Section 6.2.2;

"**Round**" means each competitive race taking place in the Championship and "**Rounds**" shall be construed accordingly;

"**RS Clubsport Category**" means each of: (i) the Amateur – RS Clubsport Category; and (ii) the Professional – RS Clubsport Category;

"**RS Clubsport Championship**" means the Entrants championship set out further in Sections 1.13.8 and 1.13.9 for Cars that compete in a RS Clubsport Category;

"**Safety Self-Declaration Form**" means the form set out at Appendix 11;

"**Safety Car**" means a vehicle used to maintain grid formation and speed in the Formation Lap and Green Flag Lap, and to neutralise the race in order to safely deal with an incident;

"**Satisfy**" has the meaning given to it in Section 3.20.4;

"**Scrutineers**" means any representative of Motorsport UK, BARC and/or Porsche who performs the Scrutineering;

"**Scrutineering**" means the Technical Scrutineering and the Eligibility Scrutineering;

"**Season**" means the period starting on and from the date of the Friday Free Practice prior to the first Meeting to (and including) the date of the End of Season Awards;

"**Senior Entrant Personnel**" means anyone representing an Entrant operating at number one mechanic level or higher, or anyone that operates on behalf of an Entrant within the Pit Lane;

"**Social Media Platform**" means any form of social media, including Facebook, Twitter, Instagram, LinkedIn, Weibo, Wikipedia, internet postings, blogs, Snapchat and chat rooms;

"**Social Media Policy**" means the policy set out in Appendix 8;

"**Staff and Vehicle Information Form**" means the form set out in Appendix 3;

"**Steward**" means, for each Meeting, each of the three stewards appointed by BARC for that Meeting in accordance with Motorsport UK Regulation G2 and "**Stewards**" shall be construed accordingly;

"**Stickers**" has the meaning given to it in Section 6.7.1;

"**Substitute Driver**" has the meaning given to it in Section 1.4.11(B);

"**Technical Regulations**" mean the regulations set out in Section 5;

"**Technical Scrutineering**" means the scrutineering undertaken at each Friday Free Practice and/or Meeting for the purposes of assessing the safety aspects of each Car;

"**Technical Team**" means, for each Meeting, the representatives of Porsche and/or the Organising Club responsible for the implementation of the Technical Regulations;

"**Test Day**" means each Friday Free Practice, each Porsche Test Day and each Other Test Day and "**Test Days**" shall be construed accordingly;

"**Test Session**" means any test on a circuit on the Friday Free Practices and the Porsche Test Days;

"**Timekeeper**" means the entity appointed as the official timekeeper for the Championship from time to time, which is Timing Solutions Limited as at the publication date of these Regulations;

"**TOCA**" means the subsidiary company of BARC responsible for its commercial activity;

"**Track**" means any track that is used as a track for an Event and "**Tracks**" shall be construed accordingly;

"**Track Licence**" means the track licence issued by Motorsport UK to a Track Operator;

"**Track Licence Limit**" has the meaning given to it in Section 3.1.1;

"**Track Limit**" means, for a Track, the boundary between that Track and being off the circuit as determined by the Clerk of the Course and communicated to Drivers during the Driver's briefing at each Event;

"**Track Operator**" means each of the owner and the operator (if different) of a Track;

"**VAT**" means value added tax or other similar tax, charge or levy;

"**VDL Materials**" has the meaning given to it in Section 5.22.8 Part A or Part B (as applicable);

"**Video Data Logger**" means the VBox HD2 video data logger provided by Porsche pursuant to Section 5.22 Part A or Part B (as applicable);

"**Virtual Flag Receiver**" has the meaning given to it in Section 5.27.1 Part A or Part B (as applicable); and

"**Zero Alcohol Level**" has the meaning given to it in Section 3.20.4.

2. In these Regulations, unless the context requires otherwise:
 - 2.1 any obligations imposed on an "**Entrant**" in these Regulations include an obligation on that Entrant to procure such obligation is complied with by any employees (direct or indirect), directors, consultants, mechanics, agents or third parties acting on that Entrant's behalf (including that Entrant's Drivers) and any third party attending any Event on the invitation of that Entrant, and that Entrant shall be primarily liable for any breach of any of these Regulations by any of the foregoing;
 - 2.2 any obligations imposed on a "**Driver**" in these Regulations include an obligation on that Driver to procure such obligation is complied with by any employees (direct or indirect), consultants, mechanics, agents or third parties acting on that Driver's behalf and any third party attending any Event on the invitation of that Driver, and that Driver shall be primarily liable for any breach of any of these Regulations by any of the foregoing;
 - 2.3 use of the singular includes the plural and vice versa and words importing any particular gender shall include all other genders;
 - 2.4 any reference to a "**Section**" is to the relevant section of these Championship Regulations and any reference to an "**Appendix**" is to the relevant appendix to these Championship Regulations;
 - 2.5 any reference to a statute, statutory provision, subordinate legislation, code or guideline ("**legislation**") is a reference to such legislation as amended and in force from time to time and to any legislation that re-enacts or consolidates (with or without modification) any such legislation;
 - 2.6 any reference to a document, agreement, regulation, code or equivalent shall be to that document, agreement, regulation, code or equivalent as amended, varied or restated from time to time;
 - 2.7 any phrase introduced by the terms "**including**", "**include**", "**such as**" "**in particular**" or any similar expression shall be construed as illustrative and shall not limit the sense of the words preceding those terms;
 - 2.8 in writing includes by email unless otherwise indicated; and
 - 2.9 the Appendices form part of these Regulations and shall have effect as if set out in full in the body of these Regulations and any reference to these Regulations includes the Appendices.
3. Any notice to be provided to a Driver in writing shall be sent by email to the email address for that Driver set out on that Driver's Registration Form and any notice to be provided to an Entrant in writing shall be sent by email to the email address of the Entrant Manager of that Entrant set out on the relevant Registration Form. Any such email shall be deemed delivered on the date and at the time it is sent.
4. Any references in these Regulations to consent or approval to be given by the Championship Coordinator shall be determined by the Championship Coordinator in their absolute and sole discretion and no decision shall be considered to be setting a precedent for any future decision of the Championship Coordinator.

5. (a) If any provision of these Regulations shall be found by any court or administrative body of competent jurisdiction to be invalid or unenforceable, such invalidity or unenforceability shall not affect the other provisions of these Regulations, which shall remain in full force and effect. (b) If any provision of these Regulations is so found to be invalid or unenforceable but would be valid or enforceable if some part of the provision were deleted, the provision in question shall apply with such deletion(s) as may be necessary to make it valid. (c) In the circumstances referred to in paragraph (a) and if paragraph (b) does not apply, Porsche shall attempt in good faith to substitute for any invalid or unenforceable provision a valid or enforceable provision that achieves to the greatest extent possible the same effect as would have been achieved by the invalid or unenforceable provision.