

NEWS FROM PORSCHE CLASSIC

ORIGINALE

09 | TEILE. TYPEN. TECHNIK.

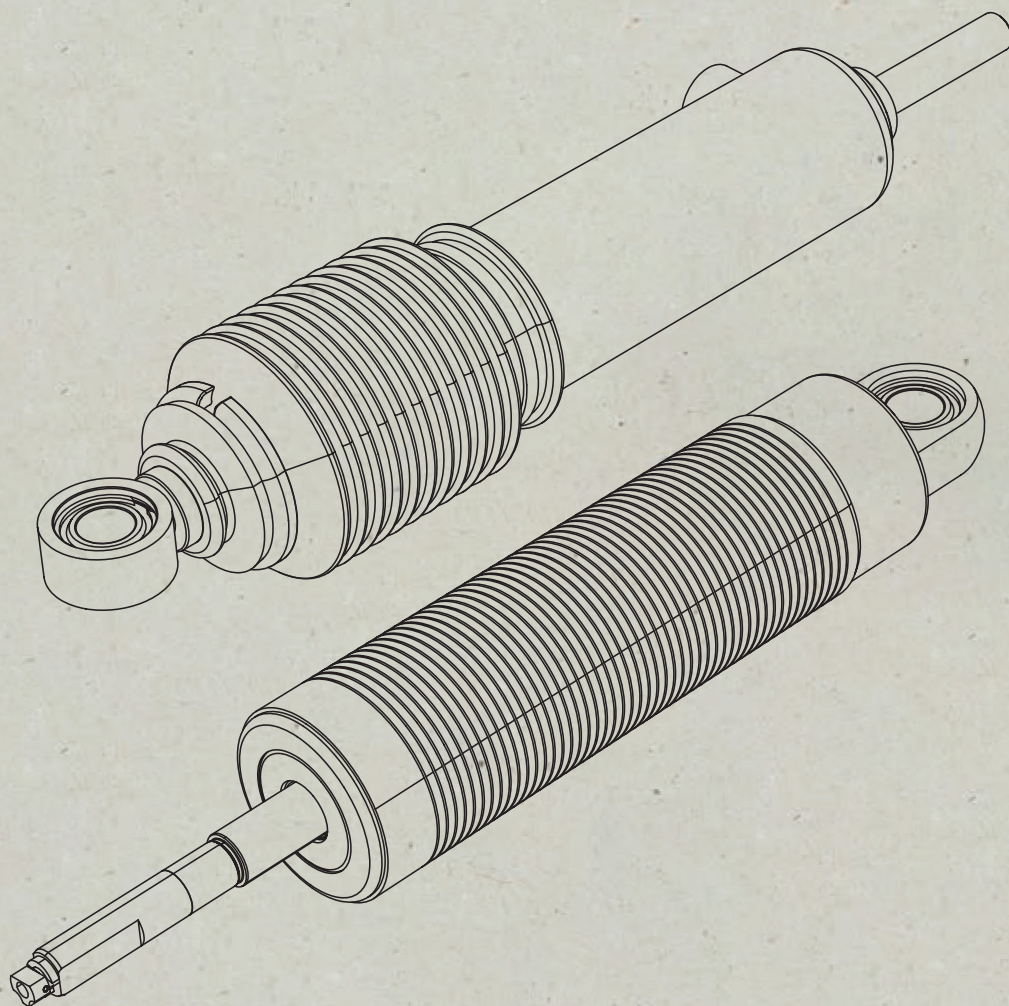

PORSCHE

3



Parts

New and proven: Selected product highlights and new editions from our extensive range of more than 80,000 Porsche Classic Genuine Parts. Our Porsche Classic Partners and Porsche Centres will be pleased to advise you.

The distinctive rear spoiler ensures optimum downforce on the 959 super sports car. The new 959 performance suspension guarantees the best driving characteristics.

Porsche Classic Genuine Parts

Part 1: On the following pages you will find a selection of illustrated Porsche Classic Genuine Parts sorted into assemblies.

Engine



Vane pump for power steering
Part no. 96434743202
964 (1989–1994), excluding 964 RS



Impeller (galvanised White hub)
Part no. 90110601001
911 F model (1965–1968), up to engine number M09090000



Water cooler
Part no. 477121251D
924 (1976–1985)



Oil line
Part no. 94420701106
Oil line from the crankcase oil circuit to the oil cooler.
968 (1992–1995)



Oil line
Part no. 94420701105
Oil line from the crankcase oil circuit to the oil cooler.
944 (1989–1991), only for S2



Shock absorber
Part no. 94410212306
944 (1989–1991), only for S2 with engine type M44/41

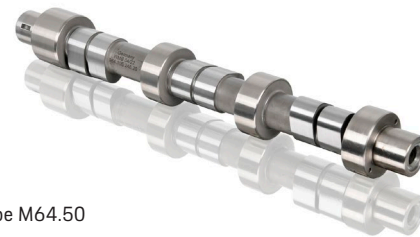

Camshaft, right
Part no. 96410524820
964 (1993), only with 3.6 L turbo engine type M64.50

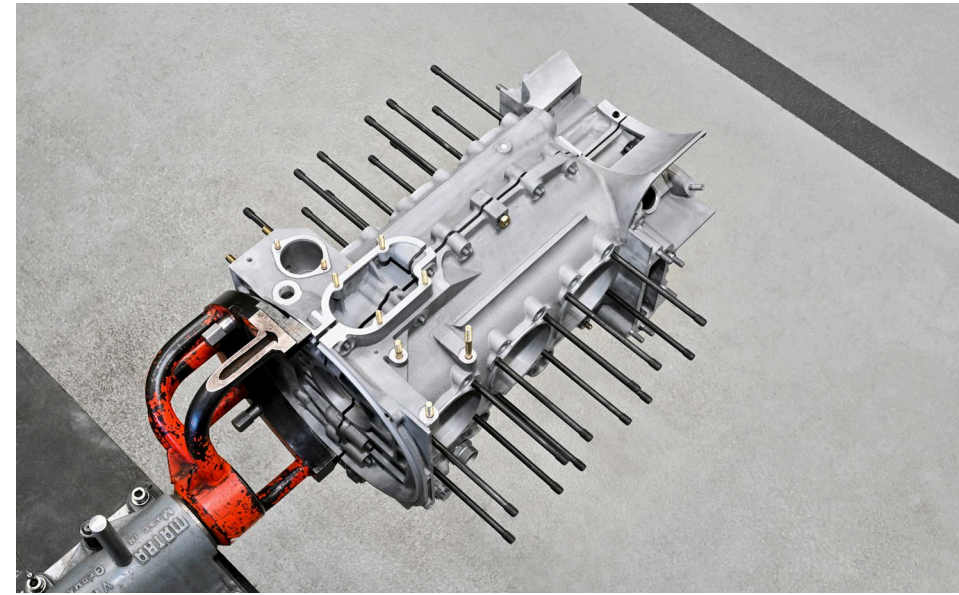

The magnesium crankcase with piston head spray nozzles for all early 911 models with 2.0 or 2.2 litre engines.

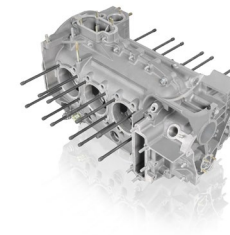

Crankcase, magnesium, 2.0L/2.2 L
Part no. 90110100146
911 F model (1968–1971), only for vehicles with 2.0 L or 2.2 L engines

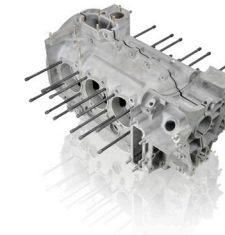

Crankcase, magnesium, 2.4 L
Part no. 90110100147
911 F model (1972–1973), only for vehicles with 2.4 L engines

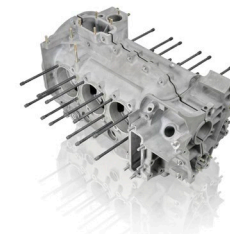

Crankcase, magnesium, 2.7 L
Part no. 91110100145
911 F model (1973), only for 911 Carrera RS 2.7
911 G model (1974–1977), only for vehicles with 2.7 L engines

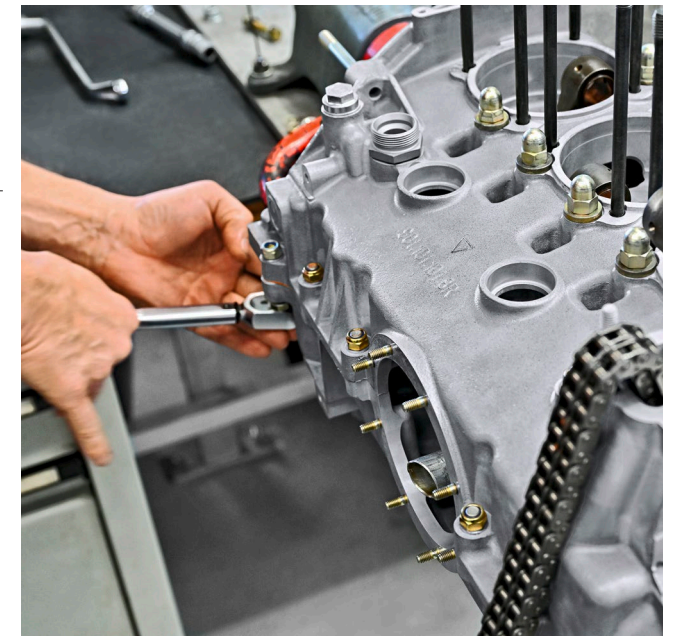

Fuel/exhaust system

Exhaust silencer with integrated wastegate pipe connection

Part no. 93011103712

911 G model (1978–1983), only for Turbo



Protective flaps, Yellow

Part no. 90120127721

Protective flaps on the tank filler neck. Prevents the vehicle's paintwork from being damaged by the pump nozzle or dripping fuel. Inspired by the 911 RS 2.7 (1972–1973); can be used as an accessory for all 911 F models.

911 F model (1965–1973)

Fuel return line

Part no. 96435636801

964 (1989–1994)



Intermediate piece of breather hoses for fuel system

Part no. 90120161922

911 F model (1969–1973)

Transmission



Socket clutch release shaft interior

Part no. 092141699

924 (1976–1985), excluding Turbo



Synchro body for shift wheel

Part no. 91530240511

911 F model (1972–1973)

911 G model (1974–1986), only for type 915 transmission

Front axle/steering

Steering tie rod

Part no. 94434703329

For vehicles with power steering (M657).

924 (1986–1988), only for S

944 (1982–1986)



Bearing cap for front axle link on body

Part no. 90134115300

911 F model (1965–1967)

Bearing block for front axle link on body

Part no. 90134115102

911 F model (1965–1967)



Front wheel hub

Part no. 93034106500

911 G model (1975–1980), only for Turbo



Spacer ring, 21 mm

Part no. 93033161107

911 G model (1975–1980), only for Turbo

924 (1979–1982), only for Turbo

928 (1978–1991)

944 (1982–1985), excluding Turbo



Side transmission cover made of aluminium, with oil pump connection

Part no. 91530131115

911 G model (1984–1986), only for Carrera, only for type 915 transmission

Transmission cover, front, with speedometer connection

Part no. 91530130113

911 F model (1972–1973)

911 G model (1974–1977), excluding Turbo





Return line

Part no. 92834744902

For vehicles with power steering (M657).

928 (1978–1982), left-hand drive only



Coil spring (1 set)

Part no. 477411105T 954

924 (1976–1985), up to model year 1980, only with M404 (anti-roll bar front and rear), excluding Turbo

Coil spring (1 set)

Part no. 477411105S 954

924 (1986–1988), only for S and Turbo
944 (1982–1988), except S and Turbo

Coil spring (1 set)

Part no. 95134353104104

944 (1987–1988), only for S and Turbo, for S only with M474 (sports shock absorbers front and rear)

Coil spring (1 set)

Part no. 94434353113904

968 (1993–1995), only for 968 CS

Coil spring (1 set)

Part no. 94434353110954

944 (1987–1989), only for 944 II and S, only with M030 (sports suspension)

Coil spring (1 set)

Part no. 95134353105904

944 (1990–1991), for 944 S2 only with M031 ('Fichtel+Sachs' sports suspension, not height-adjustable)
968 (1992–1995), excluding 968 CS

Coil spring (1 set)

Part no. 94434353112904

944 (1989), only for 944 S2, only with M474 (sports shock absorbers front and rear)

Coil spring (1 set)

Part no. 94434353111904

944 (1989–1991), only for 944 S2



Manthey performance suspension

Part no. 95904480500

959 (1987–1988), excluding 959 Sport



Manthey performance suspension

Part no. 99604480500

996 (1999–2005), only for Carrera 4S Coupe, Turbo Coupe and Turbo S Coupe

Rear axle



Torsion bar 23 mm, left
Part no. 90133310115

911 F model (1965–1973)
911 G model (1974–1977),
excluding Turbo

Torsion bar 23 mm, right
Part no. 90133310210

911 F model (1965–1973)
911 G model (1974–1977),
excluding Turbo



Torsion bar 24.1 mm, left
Part no. 91133310116

911 G model (1978–1985),
excluding Turbo

Torsion bar 24.1 mm, right
Part no. 91133310216

911 G model (1978–1985),
excluding Turbo



**Torsion bar 25 mm, left
(40/44 teeth)**
Part no. 91133310115

911 G model (1986), only for Carrera

**Torsion bar 25 mm, right
(40/44 teeth)**
Part no. 91133310215

911 G model (1986), only for Carrera

Cardan joint for drive shaft
Part no. 91433202903

914 (1970–1976)

Torsion bar 26 mm, left
Part no. 91133310113

911 G model (1975–1988), only for Turbo

Torsion bar 26 mm, right
Part no. 91133310213

911 G model (1975–1988), only for Turbo



Torsion bar 29 mm, left
Part no. 91133310114

911 G model (1984–1986)

Torsion bar 29 mm, right
Part no. 91133310214

911 G model (1984–1986)

Drawbar
Part no. 69533324101

356 (1960–1965)

Rear axle strut

Part no. 644 34105

356 (1955–1963), only for A and B



Rubber bearing for axle guide

Part no. PCG501541

924 (1976–1985)
944 (1982–1985), excluding
Turbo



Support for bump stop, left

Part no. 69533303501

356 (1963–1965), only for 356 C



Support for bump stop, right

Part no. 69533303601

356 (1963–1965), only for 356 C

Wheels/brakes



Off-road rim set 8Jx18 ET 57, matt Black

Part no. PCG362044A

Cayenne E1 (2003–2010), excluding Turbo with factory performance
upgrade and Turbo S



Are you already looking forward to your next off-road adventure with your Cayenne? Then you're about to get even more excited.

Porsche Classic has created a new off-road rim specially for the Cayenne from model years 2003 to 2010, giving the vehicle an especially robust appearance. The 18-inch off-road rim is limited to 150 sets in black (matt) and is powder-coated against damages, scratches and stone chips for a high resistance and it shines with a laser engraved Porsche logo below the valve hole. Porsche recommends the BF Goodrich All-Terrain T/A KO2 265/60 R 18 119/116 S tyres for increased off-road driving fun – the ideal combination to further explore your off-road terrain with the classic Cayenne.

Matching hub caps can be found on the following page.



Hub cap '955'
Part no. PCG955303A
The designation '955' is an internal type designation and stands for the first generation of the Cayenne E1.
Cayenne E1 I (2003–2006)

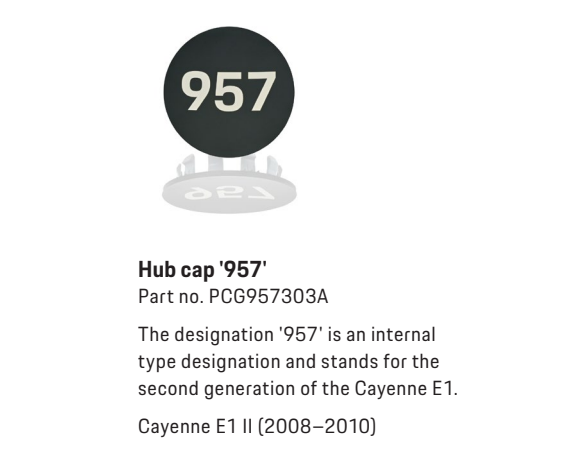

Hub cap '957'
Part no. PCG957303A
The designation '957' is an internal type designation and stands for the second generation of the Cayenne E1.
Cayenne E1 II (2008–2010)

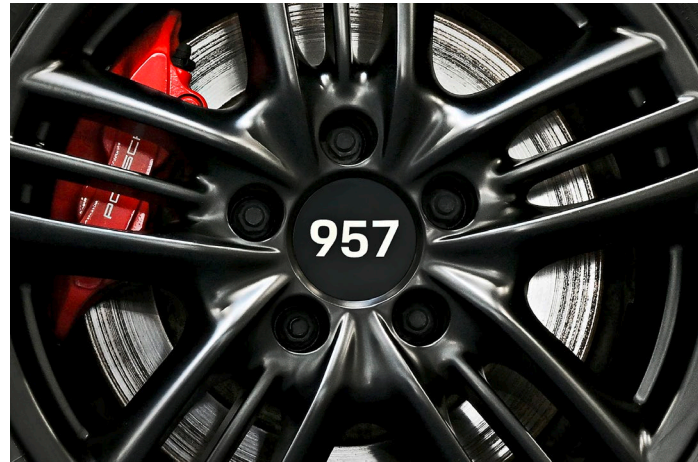

Matt Black hub cap with monochrome Porsche Crest
Part no. 9P1601147 JE1
Cayenne E1 (2003–2010)

Hand lever and pedal system



Manthey short shifter
Part no. PCG996424
Only for vehicles with manual transmission.
986 (1997–2004)
996 (1998–2005)

Gearshift lever compression spring
Part no. 91442413101
911 F model (1965–1973), excluding 915 transmission
914 (1970–1976)
911 G model (1974), only with Sportomatic transmission



Accelerator control lever
Part no. 91111011007
911 G model (1984–1989), only for Carrera



Shift rod bearing block
Part no. 477711237B
924 (1979–1982), only for Turbo



Body

Actuating button, round, for unlocking the backrest on the seat
Part no. PCG88163300
911 G model (1974–1976)



Upper sealing strip on the front apron, Black
Part no. 99350534300
993 (1994–1998), only for Carrera 2, Carrera 4 and RS



Air-conditioning switch trim on the centre console
Part no. 91155226900
911 G model (1978–1989)



Handle for Targa roof
Part no. 90156507541
911 F model (1967–1973), only for Targa
911 G model (1974–1977), only for Targa

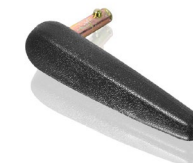

Window regulator, right
Part no. 99654207605
986 (1997–2004)
996 (1998–2005)



Glove compartment cover, left-hand drive, Black
Part no. 477857123B 1DB
924 (1976–1985), also suitable for 924 Carrera GT
944 (1982–1984)



Seat belt holder

Part no. 91155561300

911 F model (1965–1971)



Luggage compartment panelling

Part no. 90155106700

911 F model (1969–1973)

Raised countersunk head self-tapping screw, 3.9x13

Part no. PGG01409050

924 (1976–1988)
944 (1982–1985),
for attaching the exterior mirror,
excluding Turbo
959 (1987–1988),
for attaching the trim on the
front apron



Coolant hose on the heater valve 16x3.5, 90 mm

Part no. N 0202691

924 (1978–1982), only for 924
and 924 Carrera GT with PR: 573
(air-conditioning)

Hose tie

Part no. 99951216401

Hose tie for fastening the headlight
washer pump.

911 F model (1970–1973)
911 G model (1974–1983), only with head-
light washer system 959 (1987–1988)



'911' logo, Gold

Part no. 90155930521

'911' logo with pin spacing of 46 mm.

911 F model (1965–1966)

Electrical equipment



Buffer

Part no.

477807153 (left)
477807154 (right)

924 (1976–1988), without M058
(impact absorbers front and rear)

Tail light

Part no.

99663143303 (left)
99663143403 (right)

Excluding USA and Canada.

996 (1998), only for Carrera 2



Rear wiper arm

Part no. 99362802901

993 (1996–1998), only for Targa



LED reading light

Part no.

90163210203 (Chrome)
90163210202 (Black)

The desire for more light in the vehicle interior is being fulfilled in many classic Porsche models. With its classic design from the early Porsche era combined with modern LED technology, the bendable reading light in Chrome or Black blends seamlessly into the interior. In addition to the high quality materials, the well thought-out design is a highlight in itself. There are just a few simple steps between opening the popular packaging in the genuine parts design to the finished installation. No drilling. No wiring. The standard interior light above the B-pillar is simply replaced with the new LED reading light and can be removed again at any time without a trace. Of course, the light still switches on and off automatically when the doors are opened and closed.

Only for coupes and vehicles with 12V on-board electrical system. For racing use only. Not approved for road use.

356 (1959–1965)
911 F model (1965–1973), also suitable for 912
911 G model (1974–1989)
959 (1987–1988)
964 (1989–1994)
993 (1994–1998)



Left-hand drive dashboard, Black

Part no. 477857881E 1DB

924 (1976–1985), also suitable for Carrera GT
944 (1982–1985), excluding Turbo



PCCM Plus 997/987 I

Part no. 99764259500 (Asia/Africa)
 Part no. 99764259000 (Europe)
 Part no. 99764259100 (North America)

Available from your Porsche Partner: the Porsche Classic Communication Management Plus (PCCM Plus) for the Porsche 911 (type 997) and the Porsche Boxster and Cayman (type 987) up to and including model year 2008.

Your PCCM Plus combines timeless driving pleasure with state-of-the-art technology. Even if you sometimes blissfully lose track of time when driving your classic car: it is surely important for you to have an easy and comfortable trip that avoids any traffic jams. The Porsche Classic Communication Management Plus will help you achieve this.

Thanks to its design, which is perfectly tailored to classic cars, the PCCM Plus with a 7-inch touchscreen display fits seamlessly into the interior. Apple CarPlay and GOOGLE® Android Auto can also be used for navigation, telephony and media playback via the integrated USB interface. Other playback options are possible via a USB stick or Bluetooth®. Depending on the equipment in your vehicle, the functions of the multifunction steering wheel or the custom memory function for storing personal vehicle settings are supported. Other functions include the trip computer with lots of useful driving data and on-board navigation with Porsche-specific points of interest (POI) with route guidance in 2D or 3D. Viewing the navigation in the multifunction display of your vehicle is also made possible. The map material required for the onboard navigation is provided via a separate SD card, which can be ordered from your Porsche Classic Partner or your Porsche Centre.

Note: Porsche Classic recommends having the installation carried out professionally by your Porsche Partner.

997 (2005–2008), only for 997 I
 987 (2005–2008), only for 987 I



PCCM Plus Cayenne E1

Part no. 95564259500 (Asia/Africa)
 Part no. 95564259000 (Europe)
 Part no. 95564259100 (North America)

Eternal youth. Via touchscreen.

Available from your Porsche Partner: the Porsche Classic Communication Management Plus (PCCM Plus) for the first generation Porsche Cayenne up to and including model year 2008.

Your PCCM Plus combines timeless driving pleasure with state-of-the-art technology. Even if you sometimes blissfully lose track of time when driving your Cayenne: it is surely important for you to have an easy and comfortable trip that avoids any traffic jams. The Porsche Classic Communication Management Plus will help you achieve this.

Thanks to its design, which is perfectly tailored to the Porsche Cayenne, the PCCM Plus with a 7-inch touchscreen display fits seamlessly into the interior. Apple CarPlay and GOOGLE® Android Auto can also be used for navigation, telephony and media playback via the integrated USB interface. Other playback options are possible via a USB stick or Bluetooth®. Depending on the vehicle equipment of your Cayenne, the functions of the multifunction steering wheel or the reversing camera are also supported. Other functions include the trip computer with lots of useful driving data and on-board navigation with Porsche-specific points of interest (POI) with route guidance in 2D or 3D. Viewing the navigation in the multifunction display of your vehicle is also made possible. The map material required for the onboard navigation is provided via a separate SD card, which can be ordered from your Porsche Classic Partner or your Porsche Centre.

Note: Porsche Classic recommends having the installation carried out professionally by your Porsche Partner.

Cayenne E1 (2003–2008)





PCCM

Part no.
 91164559000 (Europe)
 91164259300 (Japan)
 91164559100 (North America)

Do you find yourself talking to your classic car from time to time? Now your car can talk back.

Available from your Porsche Partner: the Porsche Classic Communication Management (PCCM) for vehicles with a DIN-1 slot.

In a whole host of ways, your PCCM combines the analogue past with the digital future – for timeless driving pleasure with state-of-the-art technology. Even if you like to travel in classic style, sometimes blissfully unaware of the time, it is surely important for you to have an easy and comfortable trip that avoids any traffic jams. The new Porsche Classic Communication Management will help you achieve this.

With its unique, original Porsche look complete with Porsche logo, the PCCM blends seamlessly into the vehicle interior. In addition to touchscreen operation via a 3.5-inch display, modern functions such as Apple CarPlay have now become part of the PCCM.

Media can be played back via SD card, USB, AUX and Bluetooth®. In addition to the features already mentioned, Apple CarPlay can also be used for media playback, navigation and telephone calls.

Note: Porsche Classic recommends having the installation carried out professionally by your Porsche Partner.

- 911 F model (1965–1973)
- 914 (1970–1976)
- 911 G model (1974–1989)
- 924 (1976–1988)
- 928 (1978–1991)
- 944 (1982–1991)
- 959 (1987–1988)
- 964 (1989–1994)
- 968 (1992–1995)
- 993 (1994–1998)



PCCM Plus 996/986

Part no.
 99664259000 (Europe)
 99664259300 (Japan)
 99664259100 (North America)

Do you find yourself talking to your classic car from time to time? Now your car can talk back.

Available from your Porsche Partner: the Porsche Classic Communication Management Plus (PCCM Plus) for vehicles with a DIN-2 slot.

Your PCCM Plus combines timeless driving pleasure with state-of-the-art technology. Even if you like to travel in classic style, sometimes blissfully unaware of the time, it is surely important for you to have an easy and comfortable trip that avoids any traffic jams. The new Porsche Classic Communication Management Plus will help you achieve this.

With its unique, original Porsche look complete with Porsche logo, the PCCM Plus blends seamlessly into the interior. In addition to touchscreen operation via a high-resolution, optimised 7-inch display, modern functions such as Apple CarPlay and GOOGLE® Android Auto have now become part of the PCCM Plus.

Media can be played back via SD card, USB, AUX and Bluetooth®. In addition, the PCCM Plus can use Apple CarPlay and GOOGLE® Android Auto for media playback, navigation and telephone calls.

Note: Porsche Classic recommends having the installation carried out professionally by your Porsche Partner.

- 986 (1997–2004)
- 996 (1998–2005)



PCRN navigation software

Part no.
91164220104 (Europe)
91164220202 (USA/Canada)

Maps for your navigation system.

Thanks to Porsche Classic, your classic car won't ever change. But the maps for your navigation system will. Which is why there's a new update (as of Q2/2021) for your Porsche Classic Radio Navigation System (PCRN) (91164529000 or 91164529100) on a micro SD card (8 GB).

It's available at your Porsche Classic Partner or Porsche Centre, meaning it's incredibly easy to stay up to date.

911 F model (1965–1973)
914 (1970–1976)
911 G model (1974–1989)
924 (1976–1988)
928 (1978–1995)
944 (1982–1991)
959 (1987–1988)
964 (1989–1994)
968 (1992–1995)
993 (1994–1998)



PCCM/PCCM Plus navigation software (Europe)

Part no. PCG64250100

Suitable map material for your Porsche Classic Communication Management (PCCM) and Porsche Classic Communication Management Plus (PCCM Plus). The navigation software for Europe as at Q2/2021 is provided on a microSD card that can be ordered via your Porsche Classic Partner or your authorised Porsche Centre.

Only suitable for vehicles with PCCM/PCCM Plus (Europe).

The map material includes the following countries:

Austria, Albania, Andorra, Belarus, Belgium, Bosnia and Herzegovina, Bulgaria, Croatia, Czech Republic, Denmark, Estonia, Finland, France, Germany, Gibraltar, Great Britain, Greece, Hungary, Iceland, Ireland, Italy, Kosovo, Latvia, Liechtenstein, Lithuania, Luxembourg, Malta, Moldova, Monaco, Montenegro, Netherlands, North Macedonia, Norway, Poland, Portugal, Romania, Russia, San Marino, Serbia, Slovakia, Slovenia, Spain, Sweden, Switzerland, Turkey, Ukraine, Vatican City.

911 F model (1965–1973)
914 (1970–1976)
911 G model (1974–1989)
924 (1976–1988)
928 (1978–1991)
944 (1982–1991)
959 (1987–1988)
964 (1989–1994)
968 (1992–1995)
993 (1994–1998)
986 (1997–2004)
996 (1998–2005)
Cayenne E1 (2003–2008)
997 (2005–2008), only for 997 I
987 (2005–2008), only for 987 I



PCCM/PCCM Plus navigation software (Australia/New Zealand)

Part no. 99664250112

Modern, not classic: the map material for your Porsche Classic Communication Management (PCCM) and Porsche Classic Communication Management Plus (PCCM Plus) for the Porsche 911 (type 996) and Porsche Boxster (type 996).

The navigation software for Australia/New Zealand as at Q2/2020 is provided on a microSD card that can be ordered via your Porsche Classic Partner or the Porsche Centre.

911 F model (1965–1973)
914 (1970–1976)
911 G model (1974–1989)
924 (1976–1988)
928 (1978–1991)
944 (1982–1991)
959 (1987–1988)
964 (1989–1994)
968 (1992–1995)
993 (1994–1998)
986 (1997–2002)
996 (1998–2005)



PCCM/PCCM Plus navigation software (GCC)

Part no. 99664250114

You will receive the GCC navigation software as at Q2/2020 on a micro SD card.

The map material includes the following countries:

Bahrain, Kuwait, Oman, Qatar, Saudi Arabia, United Arab Emirates.

911 F model (1965–1973)
914 (1970–1976)
911 G model (1974–1989)
924 (1976–1988)
928 (1978–1991)
944 (1982–1991)
959 (1987–1988)
964 (1989–1994)
968 (1992–1995)
993 (1994–1998)
986 (1997–2002)
996 (1998–2005)

PCCM/PCCM Plus navigation software (North America)

Part no. 99664250201

USA/Canada navigation software as at Q2/2021 for your Porsche Classic Communication Management.

The map material includes the following countries:

USA, Canada.

911 F model (1965–1973)
914 (1970–1976)
911 G model (1974–1989)
924 (1976–1988)
928 (1978–1991)
944 (1982–1991)
959 (1987–1988)
964 (1989–1994)
968 (1992–1995)
993 (1994–1998)
986 (1997–2002)
996 (1998–2005)



PCCM Plus navigation software (Australia/New Zealand)

Part no. PCG64250200

Suitable map material for your Porsche Classic Communication Management Plus (PCCM Plus) for the Porsche 911 (type 997), Porsche Boxster/Cayman (type 987) and the first generation of Porsche Cayenne (type 9PA).

The navigation software for Australia/New Zealand as at Q4/2021 is provided on a microSD card that can be ordered via your Porsche Classic Partner or your authorised Porsche Centre.

Only suitable for vehicles with PCCM Plus (Europe).

- Cayenne E1 (2003–2008)
- 997 (2005–2008), only for 997 I
- 987 (2005–2008), only for 987 I

PCCM Plus navigation software (GCC)

Part no. PCG64250300

GCC navigation software as at Q2/2021 for your Porsche Classic Communication Management Plus (PCCM Plus) for the Porsche 911 (type 997), Porsche Boxster/Cayman (type 987) and the first generation of Porsche Cayenne (type 9PA).

Only suitable for vehicles with PCCM Plus (Asia/Africa).

The map material includes the following countries: Bahrain, Kuwait, Oman, Qatar, Saudi Arabia, United Arab Emirates.

- Cayenne E1 (2003–2008)
- 997 (2005–2008), only for 997 I
- 987 (2005–2008), only for 987 I

PCCM Plus navigation software (North America)

Part no. PCG64250400

Navigation software for North America as at Q2/2021 for your Porsche Classic Communication Management Plus (PCCM Plus) for the Porsche 911 (type 997), Porsche Boxster/Cayman (type 987) and the first generation of Porsche Cayenne (type 9PA).

Only suitable for vehicles with PCCM Plus (North America).

The map material includes the following countries: USA, Canada.

- Cayenne E1 (2003–2008)
- 997 (2005–2008), only for 997 I
- 987 (2005–2008), only for 987 I

Technical literature

Guarantee and Maintenance (English/British)

Part no. WKD90042006

Other languages are available under the following part numbers:

- English/American: WKD90042306
- German: WKD90041006
- Dutch: WKD90049106
- Swedish: WKD90049206

- 997 (2006)
- 987 Boxster (2006)
- 987 Cayman (2006)



Direct access – Short manual (English/British)

Part no. WKD98772011

Other languages are available under the following part numbers:

- German: WKD98771011
- English/American: WKD98772111
- French Canadian: WKD98773111
- Italian: WKD98774011
- Spanish: WKD98775011
- Dutch: WKD98779111
- Swedish: WKD98779211

- 987 Cayman (2011)

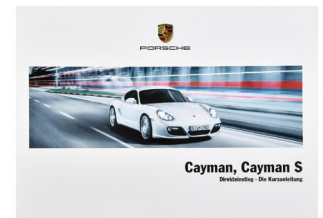

Driver's manual for Cayman, Cayman S (English/British)

Part no. WKD98762511

Other languages are available under the following part numbers:

- German: WKD98761011
- English/American: WKD98762111
- French Canadian: WKD98763111
- Italian: WKD98764011
- Spanish: WKD98765011
- Dutch: WKD98769111
- Swedish: WKD98769211

- 987 Cayman (2011)



Driver's manual for 911 GT2 (English/British)

Part no. WKD99732009

Other languages are available under the following part numbers:

- German: WKD99732009
- English/American: WKD99732109
- French Canadian: WKD99733109
- French: WKD99733009
- Italian: WKD99734009
- Spanish: WKD99735009
- Dutch: WKD99739109
- Swedish: WKD99739209

- 997 (2009), only for GT2

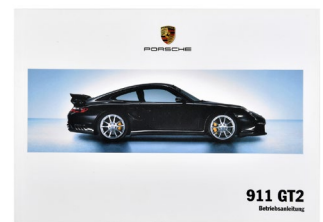

Driver's manual for 911 S (English)

Part no. WKD461020

Other languages are available under the following part numbers:

- French: WKD461030

- 911 F model (1968), only for 911 S

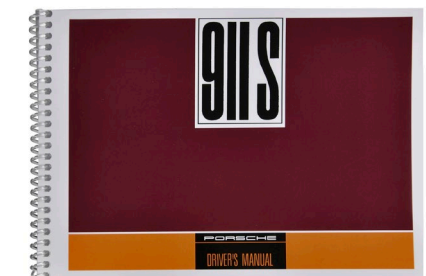



Driver's manual for 911 Turbo (German)

Part no. WKD466710

911 G model (1975), only for Turbo



Driver's manual for 911 (English)

Part no. WKD460420

911 F model (1965)



Accessories



Outdoor car cover, Silver

Part no. PCG04400080

Custom-fit outdoor car cover made of water-repellent material with coloured Porsche Crest and PORSCHE logo.

Excluding Aerokit, Turbo and GT vehicles.

996 (1998–2005), only for Carrera



100,000 km badge

Part no. PCG100000

356 (1948–1965)

911 F model (1965–1973)

914 (1970–1976)

911 G model (1974–1989)

'Ignition timing' adhesive label

Part no. 93000650103

911 G model (1984–1989), only for Turbo with factory performance upgrade

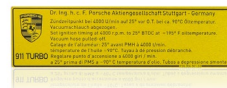

Wheel cleaner

Part no. PCG90102341

Acid free. Removes even stubborn brake wear particles.

Wheel cleaner with brush set: PCG04400086

All Classic models



Towing lug

Part no. 95572115100

Cayenne E1 (2003–2010)



Porsche Classic 75W-90 GL-5 transmission fluid metal sign

Part no. PCG04303050

All Classic models



911 Carrera RS 2.7 decal set, Blue (7-piece)

Part no. PCG55903400

911 F model (1972–1973), only for RS 2.7



911 Carrera RS 2.7 decal set, Red (7-piece)

Part no. PCG55903401

911 F model (1972–1973), only for RS 2.7



911 Carrera RS 2.7 decal set, Green (7-piece)

Part no. PCG55903402

911 F model (1972–1973), only for RS 2.7

The 911 Carrera RS 2.7 has been a thrill to drive for more than 50 years.

The decal set RS 2.7 comes in four different colours, designed especially for the legendary 911 with ducktail. For the first time the 7-part set makes a complete foliation of the popular classic possible.

Made in Germany. Application instructions are included with the set.



911 Carrera RS 2.7 decal set, Black (7-piece)

Part no. PCG55903403

911 F model (1972–1973), only for RS 2.7



The anniversary edition "60 years 911": For the 911's milestone birthday, proven accessories are dressed in a stylish red and black Pepita fabric.

The touring bag and document folder are also adorned with a badge that says "60 years 911" – as an ambassador for the 911 anniversary.

A key pouch with an embossed Porsche crest and a vehicle registration case are just as elegant for a milestone birthday.

These products are limited to 911 pieces in line with the type designation of the iconic sports car. Excluding the key pouch.



Touring bag 901, '60 Years of the 911' edition
Part no. 90180213106
All Classic models



Document folder, '60 Years of the 911' edition
Part no. PCG480901A
All Classic models



Porsche 'Werk 1' Wallpaper
Part no. PCG64472200

The 'Werk 1' (Plant 1) wallpaper from Porsche Classic gives every wall its own special story. Porsche 'Werk 1' (Plant 1) symbolises Ferry Porsche's dream of a sports car. This has always been the place where sports car dreams are created, including the iconic 911 that was developed here. The original brick wall of the factory was photographed and reproduced true to scale as the motif for the wallpaper.

One roll is 2.85 m high and 4.24 m long. The thought-out partition into 8 strips of wallpaper per roll lets you extend the wallpaper individually. When using multiple rolls, please note that the first strip shows the cornerstone of the building.

Contents: 1 roll.
All Classic models



Vehicle registration case, '60 Years of the 911' edition
Part no. PCG901200B
All Classic models



Key pouch with embossed Porsche Crest, '60 Years of the 911' edition
Part no. PCG901100A
All Classic models



Pepita document folder

Part no. PCG48090100

The on-board literature of a classic Porsche car is an expression of true passion. Literally. Reason enough for Porsche Classic to give the plastic cases that were common at the time a stylish upgrade. The new document folder combines Pepita fabric and leather in the style of the 911 cabin from model years 1964 to 1973. The appearance is topped off through a magnetic latch, the embossed Porsche vehicle crest on the cover and also through the embossed Porsche logo in the interior. In addition to an available compartment for the operating instructions and the Technical Specifications booklet for your Porsche, the document folder also has a notepad that you can take with you on every trip. This allows you to note down when the next oil change is due or the distances and times you have driven. A "Pepita" key pouch is a stylish addition in the Porsche Classic product assortment, also the touring bag 901, a car care set, a first aid kit and the tool roll for the 911 F models.

All Classic models

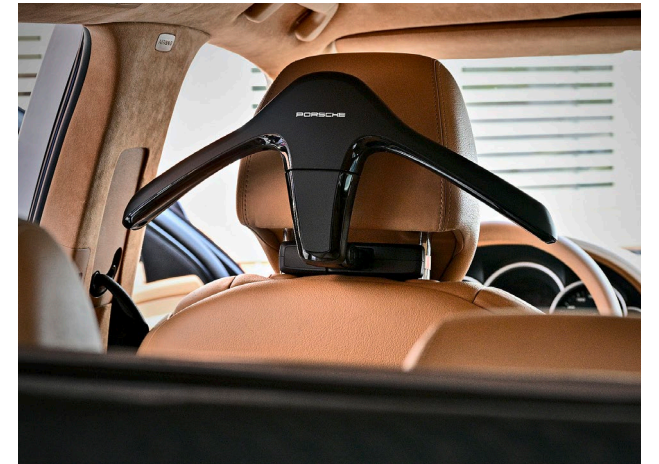

Porsche clothes hanger system

Part no. PCG862663A

Even in fast curves everything should stay in its place in a Porsche. That's why Porsche has enhanced the classic clothes hanger, making it into a system that fits like a glove when you're on the road, while ensuring wrinkle-free transport. The modular design makes the elegant clothes hanger a practical companion throughout the entire trip: after the base carrier has been securely attached with a practical click system, the hanger itself remains removable. So that the system clothes hanger with its quality soft-coated surface and the silver Porsche logo always looks good on a wardrobe a removable hook is integrated. This stylish transportation solution is available for all Porsche Macan- and Cayenne models with removable headrest.

Also usable for the Macan of the first generation as well as for newer Cayenne models (only in combination with removable headrest).

Cayenne E1 (2003–2010)



Red tartan document folder

Part no. PCG48091100

This new document folder combines tartan cloth fabric and leather in the style of the popular seat covering of the late 1970s. Made in Germany, the high-quality tartan cloth document folder fits perfectly in the glove box or simply on the passenger seat. The Porsche Classic product range includes a key pouch in tartan fabric and a tool bag for the 911 G models from model years 1974 to 1982 as stylish additions.

All Classic models



'Porsche' logo, Gold

Part no. 90155930120

911 F model (1965–1967), up to vehicle identification number 305100



'Porsche' logo, Silver

Part no. 90155930121

911 F model (1965–1967), only for 912



Porsche Classic transmission fluid filling pump

Part no. PCG72191660

All Classic models

Porsche Classic Genuine Parts

Part 2: On the following pages you will find a selection of Porsche Classic Genuine Parts sorted by model.

356

1948 – 1965

Units produced **77,766**
Available part numbers **2,100**

Rear axle
<p>Rear axle strut (1955–1963), only for 356 A and B Part no. 644 34105</p>
<p>Support for bump stop, left (1963–1965), only for 356 C Part no. 69533303501</p>
<p>Support for bump stop, right (1963–1965), only for 356 C Part no. 69533303601</p>
<p>Drawbar (1960–1965) Part no. 69533324101</p>

Body
<p>Set of trim strips (1955–1965), excluding pre A Part no. PCG55900100</p>

Electrical equipment
<p>LED reading light, Chrome (1959–1965), only for Coupes and vehicles with 12V vehicle electrical system, only for racing, not road-approved Part no. 90163210203</p>

<p>LED reading light, Black (1959–1965), only for Coupes and vehicles with 12V vehicle electrical system, only for racing, not road-approved Part no. 90163210202</p>
--

Accessories
<p>100,000 km badge (1948–1965) Part no. PCG100000</p>

911 F model

1965 – 1973

Units produced **81,100**
Available part numbers **3,500**

Engine
<p>Crankcase, magnesium 2.0/2.2 L (1968–1971), only for vehicles with a 2.0 L or 2.2 L engine Part no. 90110100146</p>
<p>Crankcase, magnesium 2.4 L (1972–1973), only for vehicles with 2.4 L engine Part no. 90110100147</p>
<p>Crankcase, magnesium 2.7 L (1973), only for 911 Carrera RS 2.7 Part no. 91110100145</p>
<p>Impeller (galvanised White hub) (1965–1968), up to engine number M09090000 Part no. 90110601001</p>

Fuel/exhaust system
<p>Protective flaps, Yellow (1965–1973) Part no. 90120127721</p>

<p>Intermediate piece of breather hoses for fuel system (1969–1973) Part no. 90120161922</p>

Transmission

<p>Transmission cover, front, with speedometer connection (1972–1973) Part no. 91530130113</p>

<p>Synchro body for shift wheel (1972–1973) Part no. 91530240511</p>

Front axle/steering
<p>Bearing block for front axle link on body (1965–1967) Part no. 90134115102</p>

<p>Bearing cap for front axle link on body (1965–1967) Part no. 90134115300</p>
--

Rear axle
<p>Torsion bar 23 mm, left (1965–1973) Part no. 90133310115</p>

<p>Torsion bar 23 mm, right (1965–1973) Part no. 90133310210</p>

Hand lever and pedal system
<p>Gearshift lever compression spring (1965–1973), excluding 915 transmission Part no. 91442413101</p>

Body

<p>Handle for Targa roof (1967–1973), only for Targa Part no. 90156507541</p>
--

<p>Seat belt holder (1965–1971) Part no. 91155561300</p>

<p>Luggage compartment panelling (1969–1973) Part no. 90155106700</p>
--

<p>Hose tie (1970–1973) Part no. 99951216401</p>

<p>'911' logo, Gold (1965–1966) Part no. 90155930521</p>

Electrical equipment
<p>LED reading light, Chrome (1965–1973), only for Coupes, also suitable for 912, only for racing, not road-approved Part no. 90163210203</p>

<p>LED reading light, Black (1965–1973), only for Coupes, also suitable for 912, only for racing, not road-approved Part no. 90163210202</p>

<p>PCCM (Europe) (1965–1973), only for Europe Part no. 91164559000</p>

<p>PCCM (Japan) (1965–1973), only for Japan Part no. 91164259300</p>

<p>PCCM (North America) (1965–1973), only for USA and Canada Part no. 91164559100</p>
--

<p>PCCM/PCCM Plus navigation software (Australia/New Zealand) (1965–1973) Part no. 99664250112</p>

<p>PCCM/PCCM Plus navigation software (Europe) (1965–1973), can only be used for vehicles with PCCM (Europe), the map material only includes selected countries Part no. PCG64250100</p>

<p>PCCM/PCCM Plus navigation software (GCC) (1965–1973) Part no. 99664250114</p>

<p>PCCM/PCCM Plus navigation software (North America) (1965–1973) Part no. 99664250201</p>

<p>PCRN navigation software (Europe) (1965–1973), for Porsche Classic Radio Navigation System (91164529000) Part no. 91164220104</p>

<p>PCRN navigation software (USA/Canada) (1965–1973), for Porsche Classic Radio Navigation System (91164529100) Part no. 91164220202</p>

Technical literature
<p>Driver's manual for 911 (English) (1965) Part no. WKD460420</p>

<p>Driver's manual for 911 S (1968), only for 911 S Part no. WKD4610XX, country code (XX) see catalogue part 01, technical literature</p>
--

Accessories
<p>911 Carrera RS 2.7 decal set, Blue (7-piece) (1972–1973), only for RS 2.7 Part no. PCG55903400</p>

<p>911 Carrera RS 2.7 decal set, Green (7-piece) (1972–1973), only for RS 2.7 Part no. PCG55903402</p>

<p>911 Carrera RS 2.7 decal set, Red (7-piece) (1972–1973), only for RS 2.7 Part no. PCG55903401</p>

<p>911 Carrera RS 2.7 decal set, Black (7-piece) (1972–1973), only for RS 2.7 Part no. PCG55903403</p>

<p>100,000 km badge (1965–1973) Part no. PCG100000</p>

<p>'Porsche' logo, Gold (1965–1967), up to vehicle identification number 305100 Part no. 90155930120</p>

<p>'Porsche' lettering, Silver (1965–1967), only for 912 Part no. 90155930121</p>
--

914

1970 – 1976

Units produced **118,982**
Available part numbers **1,700**

Rear axle
<p>Cardan joint for drive shaft (1970–1976) Part no. 91433202903</p>
<p>Hand lever and pedal system</p>

<p>Gearshift lever compression spring (1970–1976) Part no. 91442413101</p>

Electrical equipment
<p>PCCM (Europe) (1970–1976), only for Europe Part no. 91164559000</p>

<p>PCCM (Japan) (1970–1976), only for Japan Part no. 91164259300</p>

<p>PCCM (North America) (1970–1976), only for USA and Canada Part no. 91164559100</p>
--

<p>PCCM/PCCM Plus navigation software (Australia/New Zealand) (1970–1976) Part no. 99664250112</p>

<p>PCCM/PCCM Plus navigation software (Europe) (1970–1976), can only be used for vehicles with PCCM (Europe), the map material only includes selected countries Part no. PCG64250100</p>

<p>PCCM/PCCM Plus navigation software (GCC) (1970–1976) Part no. 99664250114</p>

<p>PCCM/PCCM Plus navigation software (North America) (1970–1976) Part no. 99664250201</p>

<p>PCRN navigation software (Europe) (1970–1976), for Porsche Classic Radio Navigation System (91164529000) Part no. 91164220104</p>

<p>PCRN navigation software (USA/Canada) (1970–1976), for Porsche Classic Radio Navigation System (91164529100) Part no. 91164220202</p>

Accessories
<p>100,000 km badge (1974–1989) Part no. PCG100000</p>

Engine
<p>Units produced 169,397 Available part numbers 7,100</p>

Engine
<p>Crankcase, magnesium 2.7 L (1974–1977), only for vehicles with 2.7 litre engine Part no. 91110100145</p>

Fuel/exhaust system
<p>Exhaust silencer with integrated wastegate pipe connection (1978–1983), only for Turbo Part no. 93011103712</p>

Transmission
<p>Side transmission cover made of aluminium with oil pump connection (1984–1986), only for Carrera, only for transmission type 915 Part no. 91530131115</p>

<p>Transmission cover, front, with speedometer connection (1974–1977), excluding Turbo Part no. 91530130113</p>
--

<p>Synchro body for shift wheel (1974–1986), only with transmission type 915 Part no. 91530240511</p>
--

<p>PCCM/PCCM Plus navigation software (North America) (1970–1976) Part no. 99664250201</p>

Front axle/steering
<p>Spacer ring, 21 mm (1975–1980), only for Turbo Part no. 93033161107</p>

<p>Front wheel hub (1975–1980), only for Turbo Part no. 93034106500</p>
--

Rear axle
<p>Torsion bar 23 mm, left (1974–1977), excluding Turbo Part no. 90133310115</p>

<p>Torsion bar 23 mm, right (1974–1977), excluding Turbo Part no. 90133310210</p>
--

<p>Torsion bar 24.1 mm, left (1978–1985), excluding Turbo Part no. 91133310116</p>

<p>Torsion bar 24.1 mm, right (1978–1985), excluding Turbo Part no. 91133310216</p>
--

<p>Torsion bar 25 mm, left (40/44 teeth) (1986), only for Carrera Part no. 91133310115</p>

<p>Torsion bar 25 mm, right (40/44 teeth) (1986), only for Carrera Part no. 91133310215</p>
--

<p>Torsion bar 26 mm, left (1975–1988), only for Turbo Part no. 91133310113</p>
--

<p>Torsion bar 26 mm, right (1975–1988), only for Turbo Part no. 91133310213</p>

<p>Torsion bar 29 mm, left (1984–1986) Part no. 91133310114</p>
--

<p>Torsion bar 29 mm, right (1984–1986) Part no. 91133310214</p>

Hand lever and pedal system

<p>Gearshift lever compression spring (1974), only with Sportomatic transmission Part no. 91442413101</p>
--

<p>Lever for throttle actuation (1984–1989), only for Carrera Part no. 91111011007</p>

Body
<p>Actuating button, round, for unlocking the backrest on the seat (1974–1976) Part no. PCG88163300</p>

<p>Air-conditioning switch trim on the centre console (1978–1989) Part no. 91155226900</p>

964

1989 – 1994

Units produced **63,762**
Available part numbers **5,000**

Engine
<p>Vane pump for power steering (1989–1994), excluding 964 RS Part no. 96434743202</p>
<p>Camshaft, right (1993), only with 3.6 L turbo engine type M64.50 Part no. 96410524820</p>
<p>Fuel/exhaust system</p>

Fuel return line (1989–1994)
Part no. 96435636801

Electrical equipment
<p>LED reading light, Chrome (1989–1994), only for Coupes, only for racing, not road-approved Part no. 90163210203</p>
<p>LED reading light, Black (1989–1994), only for Coupes, only for racing, not road-approved Part no. 90163210202</p>

<p>PCCM (Europe) (1989–1994), only for Europe Part no. 91164559000</p>

PCCM (Japan) (1989–1994), only for Japan
Part no. 91164259300

PCCM (North America) (1989–1994), only for USA and Canada
Part no. 91164559100

PCCM/PCCM Plus navigation software (Australia/New Zealand) (1989–1994)
Part no. 99664250112

PCCM/PCCM Plus navigation software (Europe) (1989–1994), can only be used for vehicles with PCCM (Europe), the map material only includes selected countries
Part no. PCG64250100

PCCM/PCCM Plus navigation software (GCC) (1989–1994)
Part no. 99664250114

PCCM/PCCM Plus navigation software (North America) (1989–1994)
Part no. 99664250201

PCRN navigation software (Europe) (1989–1994), for Porsche Classic Radio Navigation System (91164529000)
Part no. 91164220104

PCRN navigation software (USA/Canada) (1989–1994), for Porsche Classic Radio Navigation System (91164529100)
Part no. 91164220202

968

1992 – 1995

Units produced **11,248**
Available part numbers **5,900**

Engine
<p>Oil line (1992–1995) Part no. 94420701106</p>
<p>Front axle/steering</p>

Coil spring (1 set) (1993–1995), only for 968 CS
Part no. 94434353113904

Coil spring (1 set) (1992–1995), excluding 968 CS
Part no. 95134353105904

Electrical equipment
<p>PCCM (Europe) (1992–1995), only for Europe Part no. 91164559000</p>

PCCM (Japan) (1992–1995), only for Japan
Part no. 91164259300

PCCM (North America) (1992–1995), only for USA and Canada
Part no. 91164559100

PCCM/PCCM Plus navigation software (Australia/New Zealand) (1992–1995)
Part no. 99664250112

PCCM/PCCM Plus navigation software (Europe) (1992–1995), can only be used for vehicles with PCCM (Europe), the map material only includes selected countries
Part no. PCG64250100

PCCM/PCCM Plus navigation software (GCC) (1992–1995)
Part no. 99664250114

PCCM/PCCM Plus navigation software (North America) (1992–1995)
Part no. 99664250201

PCRN navigation software (Europe) (1992–1995), for Porsche Classic Radio Navigation System (91164529000)
Part no. 91164220104

PCRN navigation software (USA/Canada) (1992–1995) for Porsche Classic Radio Navigation System (91164529100)
Part no. 91164220202

993

1994 – 1998

Units produced **68,881**
Available part numbers **6,600**

Body
<p>Upper sealing strip on the front apron, Black (1994–1998), only for Carrera 2, Carrera 4 and RS Part no. 99350534300</p>
<p>Electrical equipment</p>

Rear wiper arm (1996–1998), only for Targa
Part no. 99362802901

LED reading light, Chrome (1994–1998), only for Coupes, only for racing, not road-approved
Part no. 90163210203

LED reading light, Black (1994–1998), only for Coupes, only for racing, not road-approved
Part no. 90163210202

PCCM (Europe) (1994–1998), only for Europe
Part no. 91164559000

PCCM (Japan) (1994–1998), only for Japan
Part no. 91164259300

PCCM (North America) (1994–1998), only for USA and Canada
Part no. 91164559100

PCCM/PCCM Plus navigation software (Australia/New Zealand) (1994–1998)
Part no. 99664250112

PCCM/PCCM Plus navigation software (Europe) (1994–1998), can only be used for vehicles with PCCM (Europe), the map material only includes selected countries
Part no. PCG64250100

PCCM/PCCM Plus navigation software (GCC) (1994–1998)
Part no. 99664250114

PCCM/PCCM Plus navigation software (North America) (1994–1998)
Part no. 99664250201

PCRN navigation software (Europe) (1994–1998), for Porsche Classic Radio Navigation System (91164529000)
Part no. 91164220104

PCRN navigation software (USA/Canada) (1994–1998) for Porsche Classic Radio Navigation System (91164529100)
Part no. 91164220202

986

1997 – 2004

Units produced **164,874**
Available part numbers **8,400**

Hand lever and pedal system
<p>Manthey short shifter (1997–2004), only for vehicles with manual transmission Part no. PCG996424</p>

Body
<p>Window regulator, right (1997–2004) Part no. 99654207605</p>
<p>Electrical equipment</p>
<p>PCCM Plus 996/986 (Europe) (1997–2004), only for Europe Part no. 99664259000</p>
<p>PCCM Plus 996/986 (Japan) (1997–2004), only for Japan Part no. 99664259300</p>

PCCM Plus 996/986 (North America) (1997–2004), only for USA and Canada
Part no. 99664259100

PCCM/PCCM Plus navigation software (Australia/New Zealand) (1997–2002)
Part no. 99664250112

PCCM/PCCM Plus navigation software (Europe) (1997–2004), can only be used for vehicles with PCCM Plus (Europe), the map material only includes selected countries
Part no. PCG64250100

PCCM/PCCM Plus navigation software (GCC) (1997–2002)
Part no. 99664250114

PCCM/PCCM Plus navigation software (North America) (1997–2002)
Part no. 99664250201

996

1998 – 2005

Units produced **175,262**
Available part numbers **13,500**

Front axle/steering
<p>Manthey performance suspension (1999–2005), only for Carrera 4S Coupe, Turbo Coupe and Turbo S Coupe Part no. 99604480500</p>

Hand lever and pedal system
<p>Manthey short shifter (1998–2005), only for vehicles with manual transmission Part no. PCG996424</p>
<p>Body</p>
<p>Window regulator, right (1998–2005) Part no. 99654207605</p>
<p>Electrical equipment</p>

Tail light, left (1998), only for Carrera 2, excluding USA and Canada
Part no. 99663143303

Tail light, right (1998), only for Carrera 2, excluding USA and Canada
Part no. 99663143403

PCCM Plus 996/986 (Europe) (1998–2005), only for Europe
Part no. 99664259000

PCCM Plus 996/986 (Japan) (1998–2005), only for Japan
Part no. 99664259300

PCCM Plus 996/986 (North America) (1998–2005), only for USA and Canada
Part no. 99664259100

PCCM/PCCM Plus navigation software (Australia/New Zealand) (1998–2005)
Part no. 99664250112

PCCM/PCCM Plus navigation software (Europe) (1998–2005), can only be used for vehicles with PCCM Plus (Europe), the map material only includes selected countries
Part no. PCG64250100

PCCM/PCCM Plus navigation software (GCC) (1998–2005)
Part no. 99664250114

PCCM/PCCM Plus navigation software (North America) (1998–2005)
Part no. 99664250201

Accessories
<p>Outdoor car cover, Silver (1998–2005), only for Carrera, excluding Aerokit, Turbo and GT vehicles Part no. PCG04400080</p>
<p>PCCM Plus navigation software (GCC) (2003–2008), can only be used for vehicles with PCCM Plus (Asia/Africa), the map material only includes selected countries Part no. PCG64250300</p>
<p>PCCM Plus navigation software (North America) (2003–2008), can only be used for vehicles with PCCM Plus (North America) Part no. PCG64250400</p>
<p>PCCM/PCCM Plus navigation software (Europe) (2003–2008), can only be used for vehicles with PCCM Plus (Europe), the map material only includes selected countries Part no. PCG64250100</p>
<p>Units produced 276,669 Available part numbers 9,900</p>

Wheels/brakes
<p>Off-road rim set, 8Jx18 ET 57, matt Black (2003–2010), excluding Turbo with factory performance upgrade and Turbo S Part no. PCG362044A</p>
<p>Hub cap '955' (2003–2006) Part no. PCG955303A</p>
<p>Hub cap '957' (2008–2010) Part no. PCG957303A</p>

Matt Black hub cap with monochrome Porsche Crest (2003–2010)
Part no. 9P1601147 JE1

Electrical equipment
<p>PCCM Plus Cayenne E1 (Asia/Africa) (2003–2008), only for South Africa, Bahrain, Kuwait, Oman, Qatar, Saudi Arabia, UAE, China, Japan, Korea, Singapore, Taiwan and Russia Part no. 95564259500</p>
<p>PCCM Plus Cayenne E1 (Europe) (2003–2008), only for Europe, Australia and New Zealand Part no. 95564259000</p>
<p>PCCM Plus Cayenne E1 I (North America) (2003–2008), only for USA and Canada Part no. 95564259100</p>

PCCM Plus navigation software (Australia/New Zealand) (2003–2008), only usable for vehicles with PCCM Plus (Europe)
Part no. PCG64250200

<p>PCCM Plus navigation software (GCC) (2003–2008), can only be used for vehicles with PCCM Plus (Asia/Africa), the map material only includes selected countries Part no. PCG64250300</p>
<p>PCCM Plus navigation software (North America) (2003–2008), can only be used for vehicles with PCCM Plus (North America) Part no. PCG64250400</p>

PCCM/PCCM Plus navigation software (Europe) (2003–2008), can only be used for vehicles with PCCM Plus (Europe), the map material only includes selected countries
Part no. PCG64250100

Accessories
<p>Towing lug (2003–2010) Part no. 95572115100</p>
<p>Porsche clothes hanger system (2003–2010) Part no. PCG862663A</p>
<p>Units produced 213,004 Available part numbers 17,300</p>

Electrical equipment
<p>PCCM Plus 997/987 I (Asia/Africa) (2005–2008), only for 997 I, only for South Africa, Bahrain, Kuwait, Oman, Qatar, Saudi Arabia, UAE, China, Japan, Korea, Singapore and Taiwan Part no. 99764259500</p>
<p>PCCM Plus 997/987 I (Europe) (2005–2008), only for 997 I, only for Europe, Australia and New Zealand Part no. 99764259000</p>
<p>PCCM Plus 997/987 I (North America) (2005–2008), only for 997 I, only for USA and Canada Part no. 99764259100</p>

PCCM Plus navigation software (Australia/New Zealand) (2005–2008), only for 997 I, can only be used in vehicles with PCCM Plus (Europe)
Part no. PCG64250200

PCCM Plus navigation software (GCC) (2005–2008), only for 997 I, can only be used for vehicles with PCCM Plus (Asia/Africa), the map material only includes selected countries
Part no. PCG64250300

PCCM Plus navigation software (North America) (2005–2008), only for 997 I, only usable for vehicles with PCCM Plus (North America)
Part no. PCG64250400

PCCM/PCCM Plus navigation software (Europe) (2005–2008), only for 997 I, can only be used for vehicles with PCCM Plus (Europe), the map material only includes selected countries
Part no. PCG64250100

Technical literature

Driver's manual for 911 GT2 (2009)
Part no. WKD9973XX09, country code (XX) see catalogue part 01, technical literature

Guarantee and Maintenance (2006)
Part no. WKD9004XX06, country code (XX), see catalogue part 01, technical literature

987 Boxster

2005 – 2012

Units produced **79,039**
Available part numbers **9,000**

Electrical equipment

PCCM Plus 997/987 I (Asia/Africa) (2005–2008), only for 987 I, only for South Africa, Bahrain, Kuwait, Oman, Qatar, Saudi Arabia, UAE, China, Japan, Korea, Singapore and Taiwan
Part no. 99764259500

PCCM Plus 997/987 I (Europe) (2005–2008), only for 987 I, only for Europe, Australia and New Zealand
Part no. 99764259000

PCCM Plus 997/987 I (North America) (2005–2008), only for 987 I, only for USA and Canada
Part no. 99764259100

PCCM Plus navigation software (Australia/New Zealand) (2005–2008), only for 987 I, can only be used in vehicles with PCCM Plus (Europe)
Part no. PCG64250200

PCCM Plus navigation software (GCC) (2005–2008), only for 987 I, can only be used for vehicles with PCCM Plus (Asia/Africa), the map material only includes selected countries
Part no. PCG64250300

PCCM Plus navigation software (North America) (2005–2008), only for 987 I, only usable for vehicles with PCCM Plus (North America)
Part no. PCG64250400

PCCM/PCCM Plus navigation software (Europe) (2005–2008), only for 987 I, can only be used for vehicles with PCCM Plus (Europe), the map material only includes selected countries
Part no. PCG64250100

Technical literature

Guarantee and Maintenance (2006)
Part no. WKD9004XX06, country code (XX), see catalogue part 01, technical literature

987 Cayman

2006 – 2012

Units produced **64,030**
Available part numbers **9,100**

Electrical equipment

PCCM Plus 997/987 I (Asia/Africa) (2006–2008), only for 987 I, only for South Africa, Bahrain, Kuwait, Oman, Qatar, Saudi Arabia, UAE, China, Japan, Korea, Singapore and Taiwan
Part no. 99764259500

PCCM Plus 997/987 I (Europe) (2006–2008), only for 987 I, only for Europe, Australia and New Zealand
Part no. 99764259000

PCCM Plus 997/987 I (North America) (2006–2008), only for 987 I, only for USA and Canada
Part no. 99764259100

PCCM Plus navigation software (Australia/New Zealand) (2006–2008), only for 987 I, can only be used in vehicles with PCCM Plus (Europe)
Part no. PCG64250200

PCCM Plus navigation software (GCC) (2006–2008), only for 987 I, can only be used for vehicles with PCCM Plus (Asia/Africa), the map material only includes selected countries
Part no. PCG64250300

PCCM Plus navigation software (North America) (2005–2008), only for 987 I, only usable for vehicles with PCCM Plus (North America)
Part no. PCG64250400

PCCM/PCCM Plus navigation software (Europe) (2006–2008), only for 987 I, can only be used for vehicles with PCCM Plus (Europe), the map material only includes selected countries
Part no. PCG64250100

Technical literature

Driver's manual for Cayman, Cayman S (2011)
Part no. WKD9876XX11, country code (XX), see catalogue part 01, technical literature

Direct access – Short manual (2011)
Part no. WKD9877XX11, country code (XX), see catalogue part 01, technical literature

Guarantee and Maintenance (2006)
Part no. WKD9004XX06, country code (XX), see catalogue part 01, technical literature

All Classic models

Accessories

Porsche Classic 75W-90 GL-5 transmission fluid metal sign
Part no. PCG04303050

Document folder, '60 Years of the 911' edition
Part no. PCG480901A

Pepita document folder
Part no. PCG48090100

Red tartan document folder
Part no. PCG48091100

Vehicle registration case, '60 Years of the 911' edition
Part no. PCG901200B

Wheel cleaner
Part no. PCG90102341

Porsche Classic transmission fluid filling pump
Part no. PCG72191660

Porsche 'Werk 1' Wallpaper
Part no. PCG64472200

Key pouch with embossed Porsche Crest, '60 Years of the 911' edition
Part no. PCG901100A

Touring bag 901, '60 Years of the 911' edition
Part no. 90180213106

Special drops for your classic cars.

The Porsche Classic Fluids.

The Porsche Classic label guarantees quality. Besides the engine oil for air-cooled four- and six cylinder boxer engines, Porsche Classic also offer engine oils for water-cooled four-, six- and eight cylinder engines. A high-performance transmission fluid that is suitable for heavily stressed transmissions is also available. You will also find brake fluid for your classic car and a fuel additive to protect from corrosion. More at www.porsche.com/classic-fluids



Porsche Classic Partners

There are 84 Porsche Classic Partners to help you – with more to follow. Find out more at www.porsche.com/classic-partner.



Australia

Porsche Centre Melbourne
109–111 Victoria Parade
Collingwood, VIC 3066
@porschemelbourneclassic
www.porschemelbourne.com.au

Belgium

Porsche Centre Brussels
Grote Baan 395
1620 Drogenbos
@porscheclassicbrussels
www.porsche.com/belgium-brussels

Canada

Pfaff Porsche
105 Four Valley Drive
Vaughan, ON L4K 4V8
@pfaff_porsche
www.pfaffporsche.com

Porsche Lauzon
2455 Boulevard Chomedey
Laval, QC H7T 2W5
@porschelauzon
www.lauzonporsche.com

Porsche Centre Vancouver
688 Terminal Ave
Vancouver, BC V6A 2M5
@porschecentrevan
www.porschevancouver.com

Porsche Centre Victoria
737 Audley Street
Victoria, BC V8X 2V4
@porsche.victoria
www.porschevictoria.com

Colombia

Porsche Centro Bogotá
Av. Carrera 70 No. 99-15
Bogotá
@porsche_bogota
dealer.porsche.com/co/bogota/es-co

Estonia

Porsche Center Tallinn
Mustamäe tee 12B
10621 Tallinn
@porscheesti
www.classic.porsche.ee/et/porsche-classic-partner

France

Centre Porsche Classic Rouen
2 bis Route du Havre
76150 Saint-Jean-du-Cardonnay
@centres_porsche_rouen_et_caen
www.centreporsche-classic.fr/rouen

Centre Porsche Lorient
179 Rue Antoine Lavoisier
Z.I de Kerpont
56600 Lanester
@porsche_lorient_et_brest
www.centreporsche.fr/lorient

Centre Porsche Vélizy
21 Avenue Louis Bréguet
78140 Vélizy
@centres_porsche_paris
www.centreporsche.fr/velizy

Germany

Porsche Zentrum 5 Seen
Am Römerstein 53
82205 Gilching-Argelsried
@porsche_5seen
www.porsche-5seen.de

Porsche Zentrum Bensberg
Meisheide 1
51429 Bergisch Gladbach
@porsche_bensberg
www.porsche-bensberg.de

Porsche Zentrum Berlin-Potsdam
Albert-Einstein-Ring 49
14532 Kleinmachnow
@porsche.berlin
www.porsche-berlin-potsdam.de

Porsche Zentrum Böblingen
Konrad-Zuse-Straße 2
71034 Böblingen
@porschezentrumboeblingen
www.porsche-boeblingen.de

Porsche Zentrum Frankfurt
Hanauer Landstraße 220a
60314 Frankfurt am Main
@porsche_frankfurt
www.porsche-frankfurt.de

Porsche Zentrum Hamburg Nord-West
Holsteiner Chaussee 151
22523 Hamburg
@porsche.hamburg
www.porsche-hamburgnordwest.de

Porsche Zentrum Hannover
Podbielskistraße 117
30177 Hannover
@porsche_hannover
www.porsche-hannover.de

Porsche Zentrum Hegau-Bodensee
Untere Giesswiesen 11
78247 Hilzingen
@porsche_zentrum_hegau_bodensee
www.porsche-hegau-bodensee.de

Porsche Zentrum Hofheim
Am Stegskreuz 2–4
65719 Hofheim am Taunus
@porsche_zentrum_hofheim
www.porsche-hofheim.de

Porsche Zentrum Hagen
Florianstrasse 1
58119 Hagen
@porsche_hagen
www.porsche-hagen.de

Porsche Zentrum Limburg
Limburger Straße 152
65582 Diez
@porsche_limburg
www.porsche-limburg.de

Porsche Zentrum Mannheim
Elsa-Brändström-Straße 11
68229 Mannheim
@porsche_mannheim
www.porsche-mannheim.de

Porsche Zentrum München
Schleibingerstraße 8
81669 München
@porsche_zentrum_muenchen
www.porsche-muenchen.de

Porsche Zentrum Moers
Am Schürmannshütt 1a + 2
47441 Moers
@porsche.niederrhein
www.porsche-moers.de

Porsche Zentrum Nürnberg-Fürth-Erlangen
Erlanger Straße 150
90425 Nürnberg
@porsche_zentrum_nuernberg
www.porsche-nuernberg.de

Porsche Zentrum Recklinghausen
Schmalkalder Straße 17
45665 Recklinghausen
@porsche_recklinghausen
www.porsche-recklinghausen.de

Porsche Zentrum Schwäbisch Gmünd
Ferdinand-Porsche-Weg 1
73529 Schwäbisch Gmünd
@porsche_schwaebisch_gmuend
www.porsche-schwaebisch-gmuend.de

Porsche Zentrum Siegen
Marienhütte 14
57080 Siegen
@porsche_siegen
www.porsche-siegen.de

Porsche Zentrum Willich
Jakob-Kaiser-Straße 1
47877 Willich
@porsche_zentrum_willich
www.porsche-willich.de

Hong Kong

Porsche Centre Hong Kong
G/F, Capital Centre
151 Gloucester Road
Wan Chai, Hong Kong
@porschecentrehongkong
www.porsche-hongkong.com

Hungary

Porsche Centrum Budapest
Szerémi út 63.
1117 Budapest
@porsche_centrum_budapest
dealer.porsche.com/hu/budapest

Ireland

Porsche Centre Dublin
M50 Exit 5 Charlestown Dr
Dublin, 11
@porschecentredublin
www.porschedublin.ie

Italy

Centro Assistenza Porsche Catania
Via Stabilimenti, 156–160
95010 Santa Venerina (CT)
@porsche_palazzo
dealers.porscheitalia.com/cataniapalazzo/ita

Centro Assistenza Porsche Padova Est
Via IX Strada, 24 – Z.I.
35129 Padova (PD)
@centro_ass_porsche_padova_est
dealers.porscheitalia.com/padovaest/ita/chi-siamo

Centro Porsche Milano Est
Via Rubattino, 94
20134 Milano (MI)
@centriporschemilano
dealers.porscheitalia.com/milanoest/ita

Centro Porsche Roma

Via Appia Nuova, 773
00178 Rome (RM)

📍 centriporschediroma
dealers.porscheitalia.com/roma/ita

Japan

Porsche Center Aoyama-Setagaya

3-15-13 Sakura Setagaya-ku

📍 Tokyo 156-0053

porschecenter_aoyama

www.porsche-setagaya.jp

Porsche Center Nagoya

5-7-1 Chiyoda Naka-ku

Nagoya City 460-0012

📍 porsche_nagoya

www.porsche.co.jp/dealers/nagoya

Porsche Center Sakai

2-1-18 Kitashimizu-machi, Sakai-ku

Sakai 590-0004, Osaka

📍 porschesakai.0911

www.porsche.co.jp/dealers/sakai

Porsche Center Yokohama Aoba

351-1 Eda-chou Aoba-ku,

Yokohama-City, Kanagawa 225-0013

📍 porschecenteryokohama

www.porsche-yokohama.co.jp

Lebanon

Porsche Centre Lebanon

Parkview Building

P.P Box 11-906, Minet el Hosn, Beirut

2020-4604 Lebanon

📍 porschecentrelibanon

www.porsche.com/middle-east/_lebanon

Luxembourg

Garage André Losch – Porsche Zenter Roost

4, rue André Losch

7759 Roost

📍 porsche_luxembourg

www.porsche.lu

Malaysia

Porsche Center Johor Bahru

No.21, Persiaran Danga Perdana,

Danga Bay 80200

Johor Bahru

dealer.porsche.com/my/johorbahru

Netherlands

Porsche Classic Center Gelderland

Ressenerbroek 2

6666 MR Heteren

📍 porscheclassiccentergelderland

www.porscheclassiccentergelderland.nl

Porsche Centrum Amsterdam

Sijssesbergweg 50

1105 AL Amsterdam Zuidoost

📍 porschecentrumamsterdam

www.porschecentrumamsterdam.nl

Porsche Centrum Eindhoven

De Scheper 305

5688 HP Oirschot

📍 porschecentrumeindhvmaastricht

www.porschecentrumeindhoven.nl

Porsche Centrum Leusden

Zuiderinslag 8

3833 BP Leusden

📍 porschecentrumleusden

www.porschecentrumleusden.nl

Porsche Centrum Rotterdam

Schuttevaerweg 116

3044 BB Rotterdam

📍 porschecentrumrotterdam

www.porschecentrumrotterdam.nl

Norway

Porsche Classic Center Son

Brevikbråteveien 33

1555 Son

📍 porscheclassiccenterson

dealer.porsche.com/no/son

Poland

Porsche Centrum Wrocław

Aleja Karkonoska 54

53-015 Wrocław

📍 porsche_wroclaw

www.porsche-wroclaw.pl

Portugal

Centro de Serviço Porsche Estoril

Rua D. Diniz Bordalo Pinheiro, 3 e 4

Centro Empresarial Ribeira da Penha Longa

2645-539 Alcabideche

📍 centrodesservicoporscheestoril

www.servicoporsche-estoril.com/

Russia

JSC Sportcar-Center Moscow

MKAD 61st km, bld.1

Razdory village, Odintsovo district

143082 Moscow Region

📍 porsche_sportcarcenter

www.sportcar-center.com

South Africa

Porsche Centre Cape Town

Corner Century Avenue and

Summer Greens Drive

7446 Century City, Cape Town

📍 porschecentre_cpt

www.porschecapetown.com

Porsche Centre Pretoria

452 Botterklapper Street

Die Wilgers

0081 Pretoria

📍 porschecentre_pta

www.porschepretoria.com

Spain

Centro Porsche Barcelona

Calle de la Botánica, 89

08908 L'Hospitalet de Llobregat

Barcelona

📍 porschebarcelona

www.porsche-barcelona.com

Centro Porsche Madrid Norte

Avenida de Burgos 87

28050 Madrid

📍 porsche.madrid

www.porsche-madridnorte.com

Switzerland

Centre Porsche Classic Genève

Impasse Colombelle 2

1218 Le Grand-Saconnex

📍 porscheclassiccenter_geneve

www.porsche-zentrum.com/pch-genf

Porsche Zentrum Zug

Blegistrasse 7

6343 Rotkreuz

📍 porschezug

www.porsche-zug.ch

Porsche Zentrum Zürich-Schlieren

Bernstrasse 59

8952 Zurich-Schlieren

📍 porschezuerich

www.porsche-zuerich.ch

Taiwan

Porsche Centre Taipei

88 Shitan Rd., Neihu Dist., Taipei City

114 Taiwan

📍 porschecentretaipei

www.porsche.com/taiwan/zh-tw/

Thailand

Porsche Centre Bangkok

36/9, 16-18, Vibhawadi-Rangsit Road

Sanambin, Donmuang

Bangkok, 10210

📍 porschecentrebangkok

www.porsche.com/pap/_thailand

United Arab Emirates

Porsche Centre Dubai

Sheikh Zayed Road

Next to Interchange 3

Dubai

📍 porschecentredubai

www.porschedubai.com

United Kingdom

Porsche Centre Bournemouth

Cobham Road

Ferndown Industrial Estate

Wimborne Dorset, BH21 7ED

📍 porschebournemouth

www.porschebournemouth.co.uk

Porsche Centre Glasgow

9 Rocep Way, Braehead

Renfrew, PA4 8XT

📍 porschecentreglasgow

www.porscheglasgow.co.uk

Porsche Centre Hatfield

1 Hatfield Avenue

Hatfield Business Park

Hatfield, Hertfordshire, AL10 9UA

📍 porschecentrehatfield

www.porschehatfield.co.uk

Porsche Centre Leeds

The Boulevard

City West Business Park

Leeds, LS12 6BG

📍 porschecentreleeds

www.porscheleeds.co.uk

Porsche Centre Swindon

Frankland Road, Blagrove

Swindon, SN5 8YG

📍 porschecentreswindon

www.porschесwindon.co.uk

USA

Gaudin Porsche of Las Vegas

6800 Redwood Street

Las Vegas, NV 89118

📍 gaudinporschelv

www.gaudinporschelv.com

Hennessy Porsche North Atlanta

990 Mansell Road

Roswell, GA 30076

📍 hennessyporsche

www.hennessyporsche.com

Napleton Westmont Porsche

201 E. Ogden Avenue

Westmont, IL 60559

📍 westmont_porsche

www.westmontporsche.com

Paul Miller Porsche

3419 Route 46 East

Parsippany, NJ 07054

📍 paulmillerporsche

www.paulmillerporsche.com

Porsche Bellevue

11910 NE 8th St

Bellevue, WA 98005

📍 porsche.bellevue

www.porschebellevue.com

Porsche Chandler

1010 S. Gilbert Road

Chandler, AZ 85286

📍 porschechandler

www.porschechandler.com

Porsche of Colorado Springs
917 Motor City Drive
Colorado Springs, CO 80905
@porschecolorado
www.porscheofcoloradosprings.com

Porsche Gold Coast
125 S Service Rd
Jericho, NY 11753
@porschegoldcoastny
www.porschegoldcoast.com

Porsche Jacksonville
11211 Atlantic Blvd
Jacksonville, FL 32225
@porschejacksonville
www.porschejacksonville.com

Porsche Monterey
1781 Del Monte Boulevard
Seaside, CA 93955
@porschemonterey
www.porschemonterey.com

Porsche North Houston
13911 North Freeway
Houston, TX 77090
@porschehouston
www.porschenorthhouston.com

Porsche Ontario
2262 Inland Empire Blvd.
Ontario, CA 91764
@porscheontario
www.porscheontario.com

Porsche Palm Springs
3735 E Palm Canyon Drive
Palm Springs, CA 92264
@porschepalmsprings
www.porschepalmsprings.com

Porsche San Diego
9020 Miramar Road
San Diego, CA 92126
@porschсандiego
www.porscheofsandiego.com

Porsche South Bay
14610 Hindry Avenue
Hawthorne, CA 90250
@porschessouthbay
www.porschessouthbay.com

Porsche Southpoint
122 Kentington Drive
Durham, NC 27713
@porschessouthpoint
www.porschessouthpoint.com

THE PLACE FOR PORSCHE ORIGINALE

Just drop into your Porsche Classic Centre
or your Porsche Classic Partner.
They have something special
waiting for you.



**True classic love deserves
a modern heart.**

Porsche Classic Communication Management systems.

Enjoy modern entertainment options and the benefits of connecting your smartphone to your classic car. Matched to the design of your Porsche Classic model, the PCCM and PCCM Plus systems show you all important information at a glance. This gives you a better overview – and enhances your classic car's timeless design. Find out more at www.porsche.com/classic-pccm



A mark of quality:

All products manufactured by Porsche – and therefore all Porsche Classic Genuine Parts – are marked with the Porsche trademark known as the “P in the triangle” either directly on the part itself or on the sales packaging.

Please only use genuine Porsche spare parts for your vehicle. You can obtain these parts from authorised Porsche dealers. Your Porsche Partner is familiar with the verified range of parts and will be happy to advise you. Porsche will not accept any liability for damage caused by the use of spare parts or accessories not authorised by Porsche.

The safety of the vehicle may be affected, even if a supplier of accessories or parts has obtained a general operating licence. The huge variety of products available on the accessories market means that Porsche is not able to verify such parts. Please note that the guarantee for your vehicle may also be affected if you use parts that are not authorised by Porsche. Porsche reserves the right to alter the design, equipment and scope of delivery without prior notice. Colour tones and materials may differ from those illustrated.

Due to country-specific legislation and requirements, product contents may differ from those described and individual items may not be available for all models in certain countries.

© Dr. Ing. h.c. F. Porsche AG, 2023. All text, pictures and other information contained in this catalogue is subject to copyright of Dr. Ing. h.c. F. Porsche AG.

Any reproduction, distribution or other use is prohibited without advance written permission from Dr. Ing. h.c. F. Porsche.

Porsche, the Porsche Crest, 911, Carrera, Boxster, Tiptronic and other distinctive features are registered trademarks of Dr. Ing. h.c. F. Porsche AG.

Dr. Ing. h.c. F. Porsche AG supports the use of paper from sustainable forest management. The paper used to make this sales brochure is certified according to the strict conditions of PEFC (Programme for the Endorsement of Forest Certification).

Dr. Ing. h.c. F. Porsche AG
Porscheplatz 1
70435 Stuttgart
Germany
www.porsche.com

Date: 08/2023
Printed in Germany
WSLU090920 EN-WW
www.porsche.com/classic

