



PORSCHE

Sinopsis de modelos Porsche Classic

Denominación del modelo	Año de modelo (AM)	Denominación del modelo	Año de modelo (AM)
356 Urmmodell/356 A/356 B/356 C:		944:	
356 Coupé, todos derivados	1948 hasta 1965	944 Coupé, todos derivados	1982 hasta 1991
356 Cabriolet, Speedster American-Roadster, todos derivados	1948 hasta 1965	944 Cabriolet, todos derivados	1989 hasta 1991
356 Convertible-D (Hardtop), Hardtop-Cabriolet, todos derivados	1952 hasta 1965	959:	
		959 Coupé, todos derivados	1986 hasta 1988
550:		911 (964):	
550 Coupé, todos derivados	1952 hasta 1957	911 Coupé, todos derivados	1989 hasta 1994
550 Spyder, todos derivados	1953 hasta 1957	911 Targa, todos derivados	1990 hasta 1994
911 Urmmodell:		911 Cabriolet, Speedster, todos derivados	1990 hasta 1994
911 Coupé, todos derivados	1965 hasta 1973	911 Turbo, todos derivados	1990 hasta 1994
911 Targa, todos derivados	1965 hasta 1973	968:	
911 G-Model:		968 Coupé, todos derivados	1991 hasta 1995
911 Coupé, todos derivados	1974 hasta 1989	968 Cabriolet, todos derivados	1991 hasta 1995
911 Targa, todos derivados	1974 hasta 1989	911 (993):	
911 Cabriolet, todos derivados	1983 hasta 1989	911 Coupé, todos derivados	1994 hasta 1998
911 G-Model Turbo (930):		911 Targa, todos derivados	1994 hasta 1998
911 Coupé, todos derivados	1975 hasta 1989	911 Cabriolet, todos derivados	1994 hasta 1998
911 Targa, todos derivados	1986 hasta 1989	Boxster (986):	
911 Cabriolet, todos derivados	1986 hasta 1989	Boxster Cabriolet, todos derivados	1997 hasta 2004
912:		911 (996):	
912 Coupé, todos derivados	1965 hasta 1969	911 Coupé, todos derivados	1998 hasta 2005
912 Coupé E, todos derivados	A partir del AM 1976	911 Targa, todos derivados	1998 hasta 2005
912 Targa, todos derivados	1965 hasta 1969	911 Cabriolet, todos derivados	1998 hasta 2005
914:		980:	
914 Targa, todos derivados	1970 hasta 1976	980 Carrera GT, Cabriolet, todos derivados	2003 hasta 2006
924:			
924 Coupé, todos derivados	1976 hasta 1988		
928:			
928 Coupé, todos derivados	1977 hasta 1995		

Advertencia legal:

© Dr. Ing. h.c. F. Porsche AG

Estado: 02/2019



PORSCHE

Advertencia legal:

Las fichas de datos de seguridad de Porsche han sido elaboradas exclusivamente para personal de salvamento que disponga de la correspondiente formación profesional técnica en el ámbito del salvamento de víctimas en vehículos accidentados, y deben ser utilizadas exclusivamente para ese fin.

Incluyen información, entre otras, sobre la naturaleza de la carrocería, los sistemas de seguridad pasiva y los sistemas de propulsión alternativos, y representan el mayor número de variantes de equipamiento posible.

Porsche carece conocimientos especializados en la ejecución de tareas de salvamento, por lo que todas las fuerzas de salvamento deben valorar esta información con anterioridad a la práctica de las tareas de salvamento, así como elaborar estrategias y adoptar decisiones basándose en sus propios conocimientos profesionales. Recomendamos a todas las fuerzas de salvamento que, en el contexto de sus ejercicios prácticos, examinen vehículos representativos de Porsche al objeto de comprender esta información en toda su extensión.

La obra, incluidos sus fragmentos, está amparada por el derecho de propiedad intelectual. Cualquier aprovechamiento o utilización comercial requerirá el previo consentimiento por escrito de Porsche AG. Lo anterior rige en particular en relación con la reproducción, transformación, tratamiento, traducción o microfilmación, así como el almacenamiento y/o tratamiento en sistemas electrónicos, incluidas las bases de datos y los servicios en línea.

La compañía Porsche AG se reserva expresamente el derecho a efectuar en cualquier momento adaptaciones o modificaciones de los contenidos de las fichas técnicas de salvamento. Las informaciones eran actuales en el momento de su elaboración. Porsche no está obligada a la actualización, modificación o sustitución de esta información.



Porsche AG, 356 Urmodell, 356 A, 356 B, 356 C

Coupé, todos derivados

PORSCHE

mod. 1948 hasta el mod. 1965

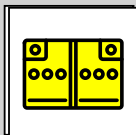
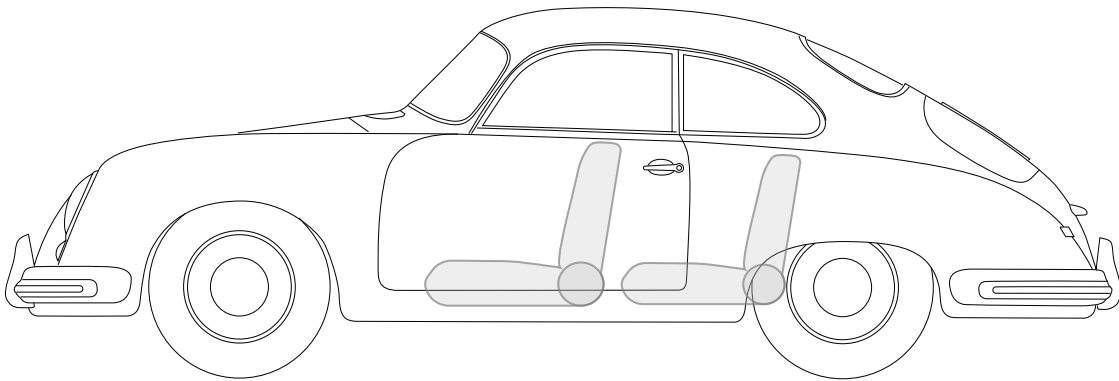
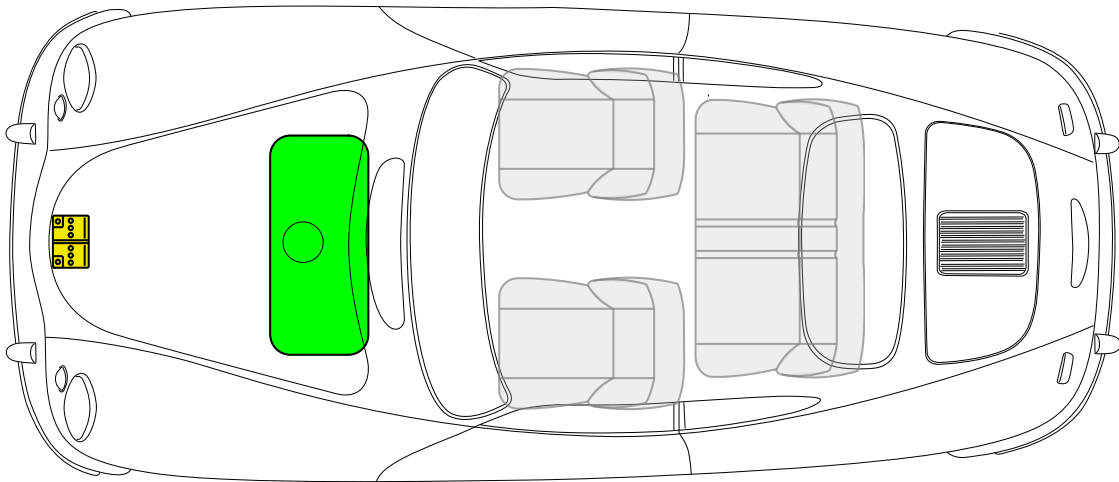

Batería

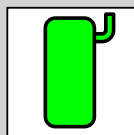

Depósito de combustible



**Porsche AG, 356 Urmodell, 356 A, 356 B, 356 C
Cabriolet, Speedster/American-Roadster,
todos derivados, mod. 1948 hasta el mod. 1965**

PORSCHE

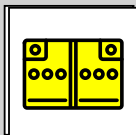
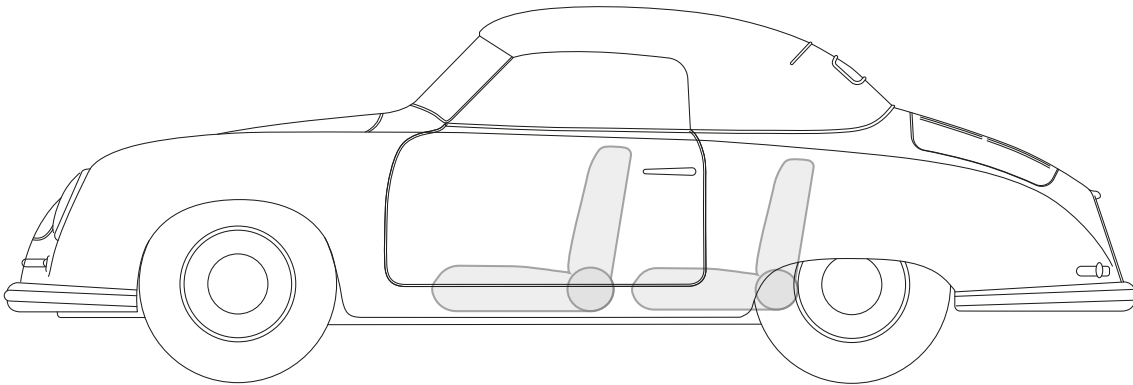
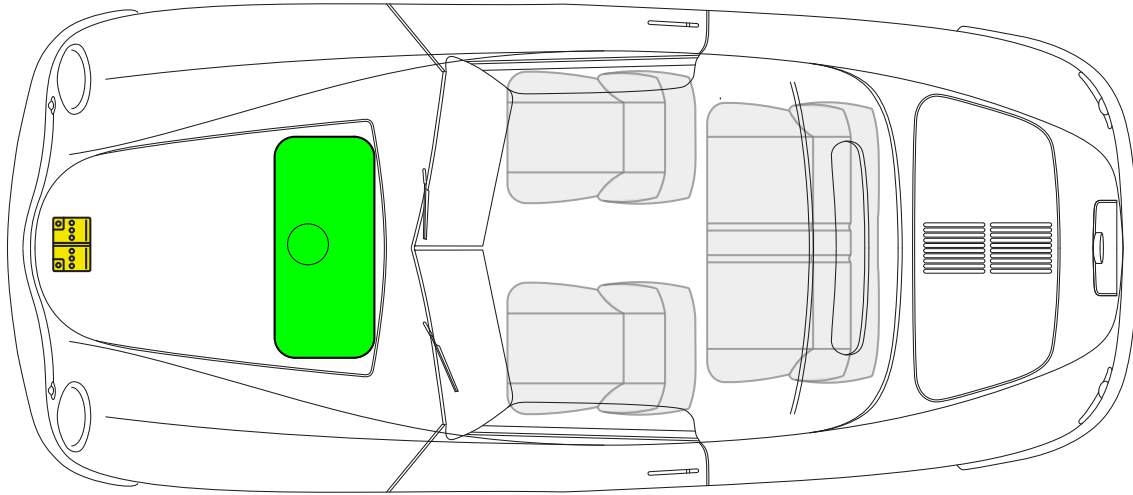

Batería

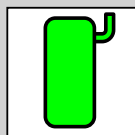

Depósito de combustible



**Porsche AG, 356 Urmodell, 356 A, 356 B, 356 C
Convertible-D (Hardtop), Hardtop-Cabriolet, todos derivados,
mod. 1952 hasta el mod. 1965**

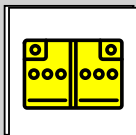
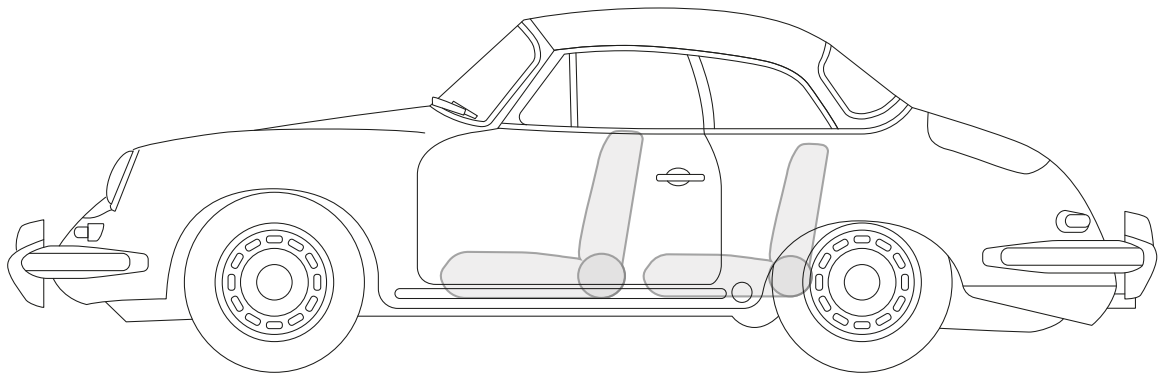
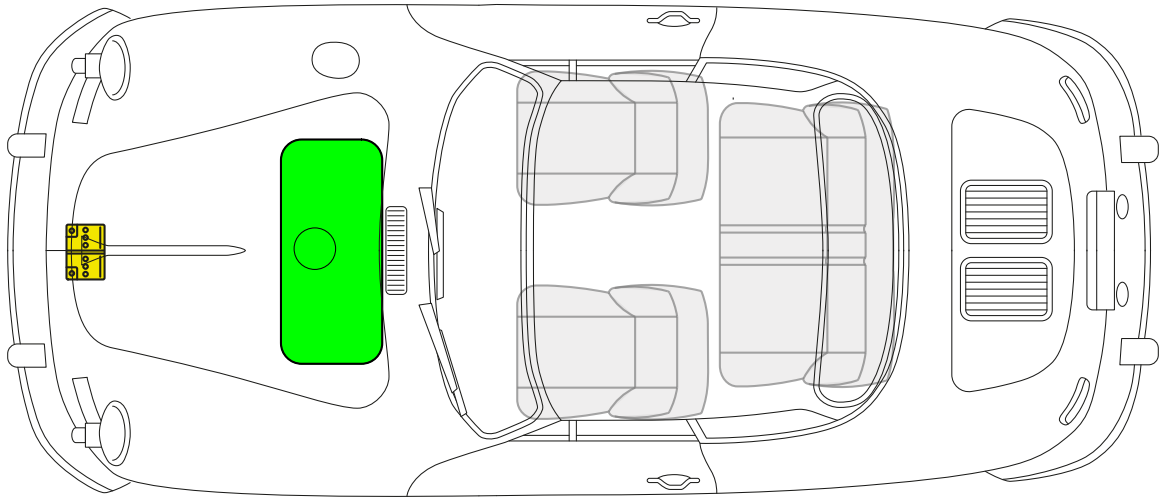

Batería

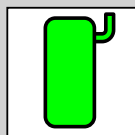

Depósito de combustible



**Porsche AG, 550, Coupé,
todos derivados,
mod. 1952 hasta el mod. 1957**

PORSCHE

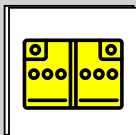
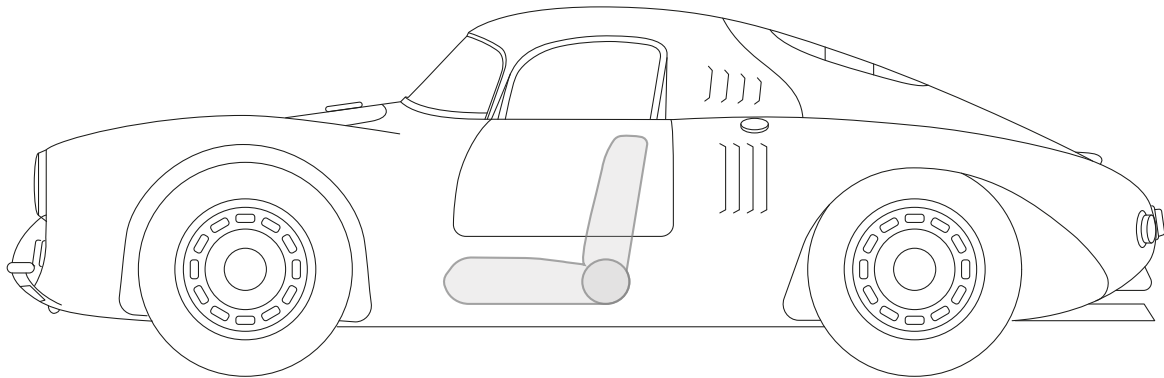
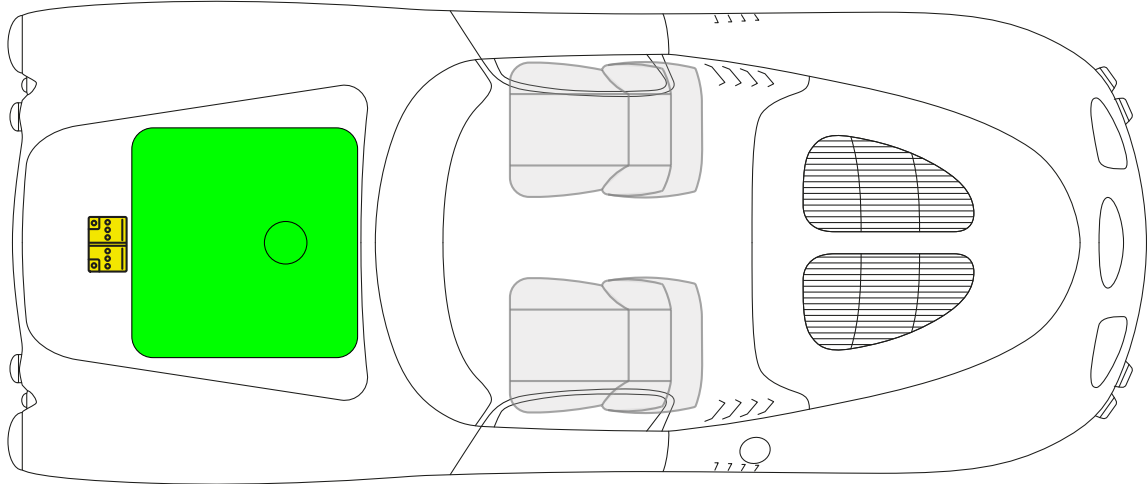

Batería

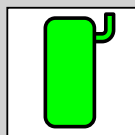

Depósito de combustible



**Porsche AG, 550, Spyder,
todos derivados,
mod. 1953 hasta el mod. 1957**

PORSCHE

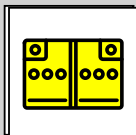
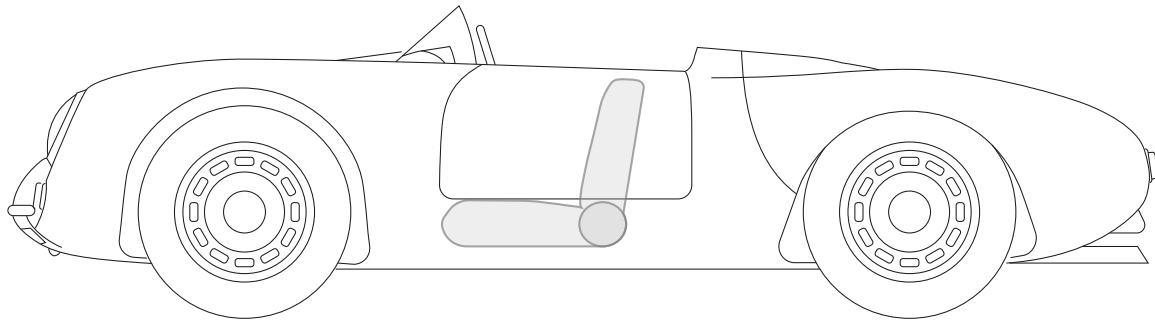
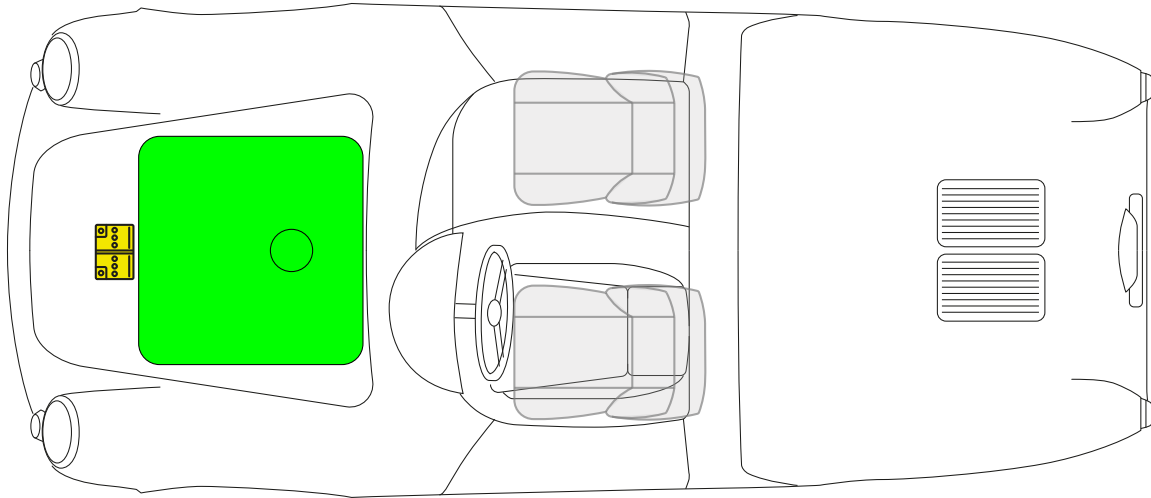

Batería

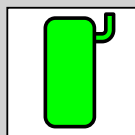

Depósito de
combustible



**Porsche AG, 911 Urmodell, Coupé,
todos derivados,
mod. 1965 hasta el mod. 1973**

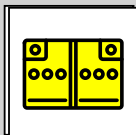
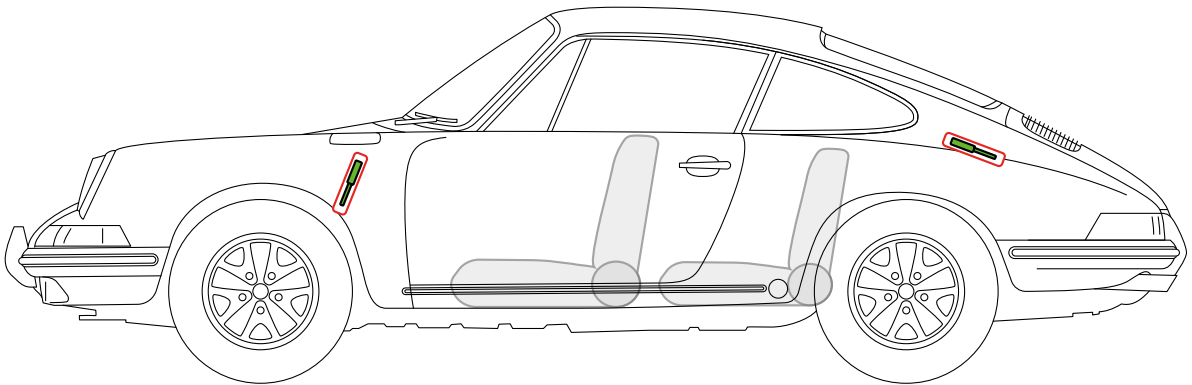
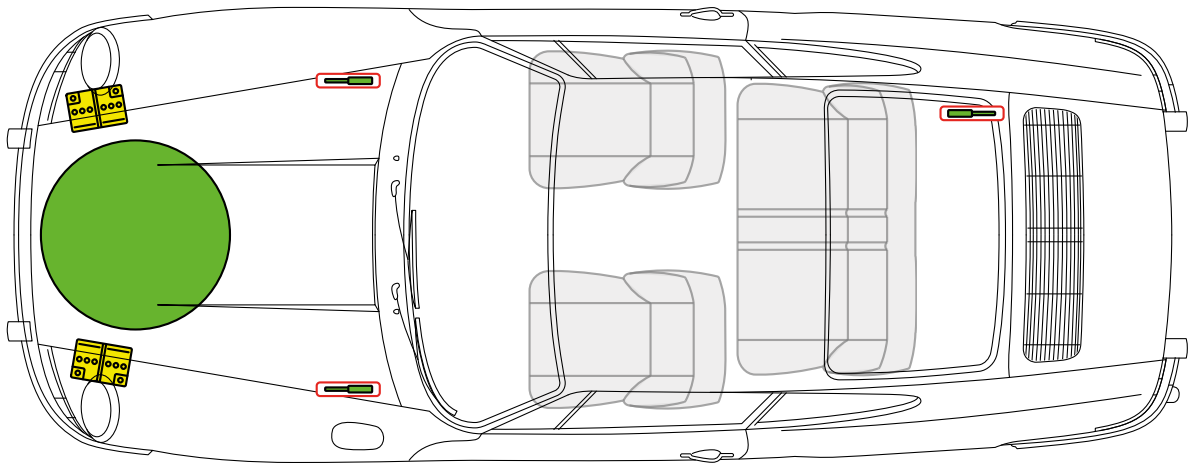

Batería

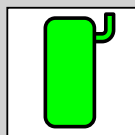

Depósito de combustible

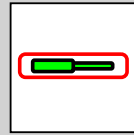

Amortiguador a gas



**Porsche AG, 911 Urmodell, Targa,
todos derivados,**

PORSCHE mod. 1965 hasta el mod. 1973

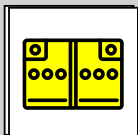
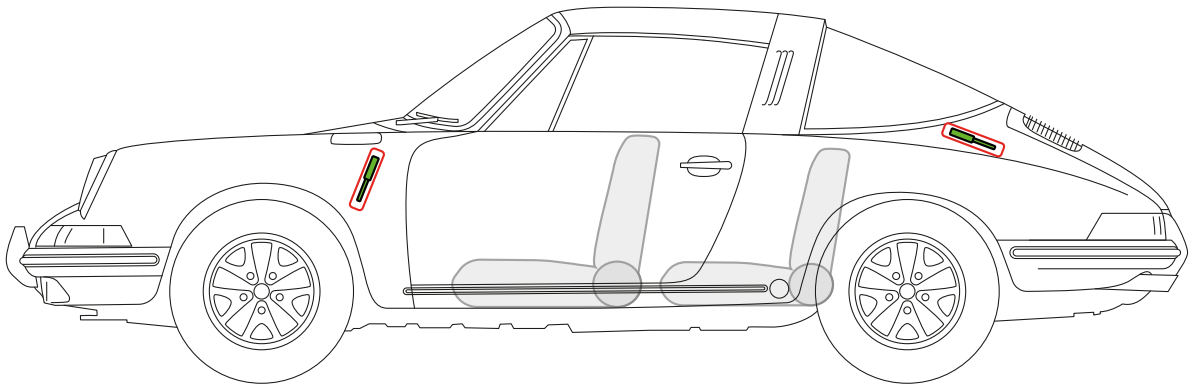
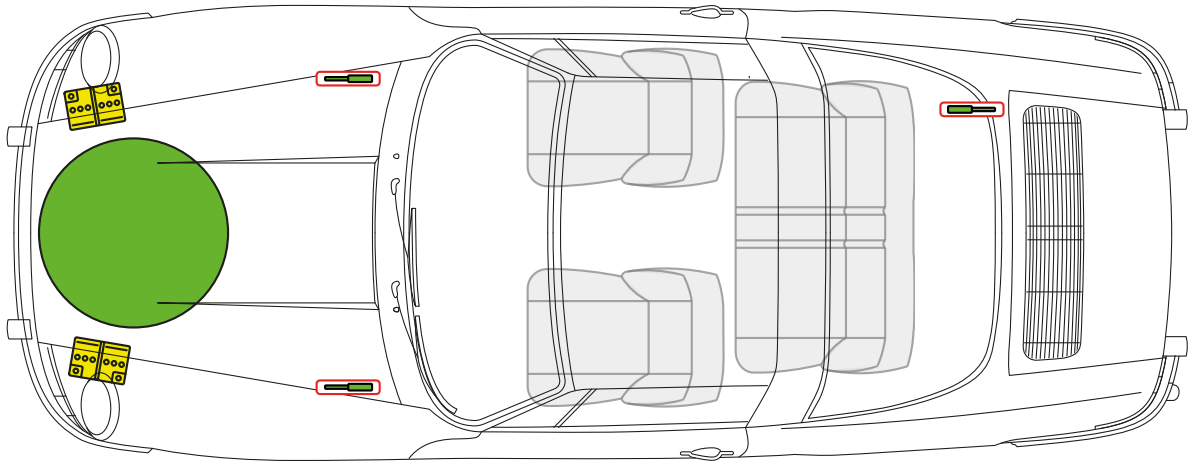

Batería

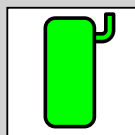

Depósito de
combustible

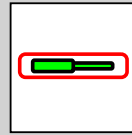

Amortiguador
a gas



**Porsche AG, 911 G-Model, Coupé,
todos derivados,**

PORSCHE mod. 1974 hasta el mod. 1989

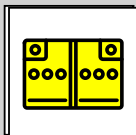
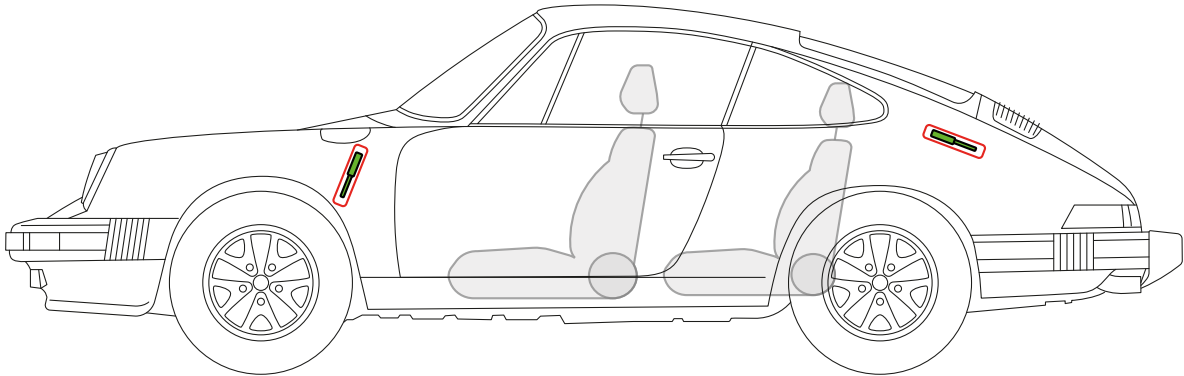
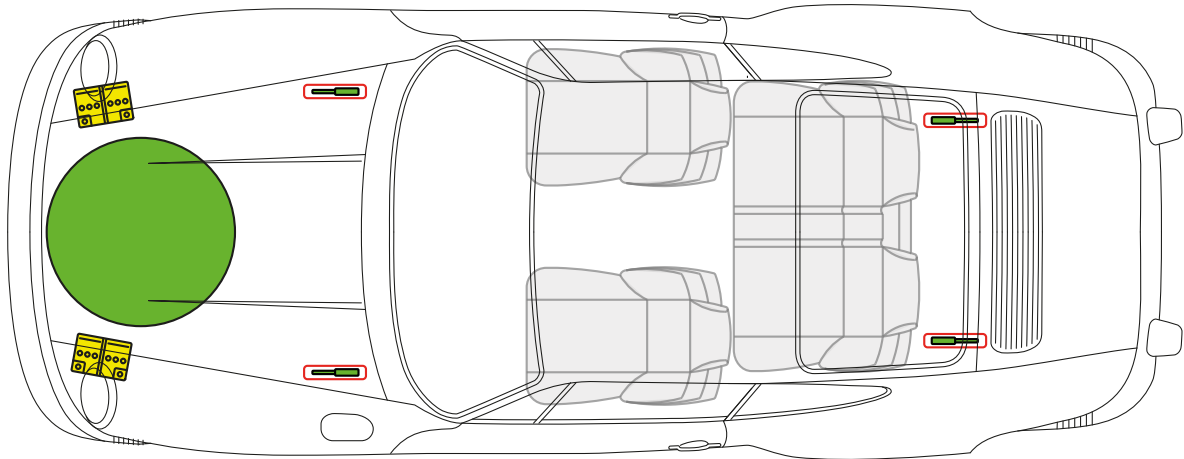

Batería

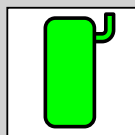

Depósito de combustible

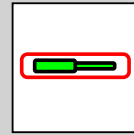

Amortiguador a gas



**Porsche AG, 911 G-Model, Targa,
todos derivados,**

PORSCHE mod. 1974 hasta el mod. 1989

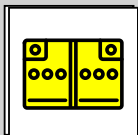
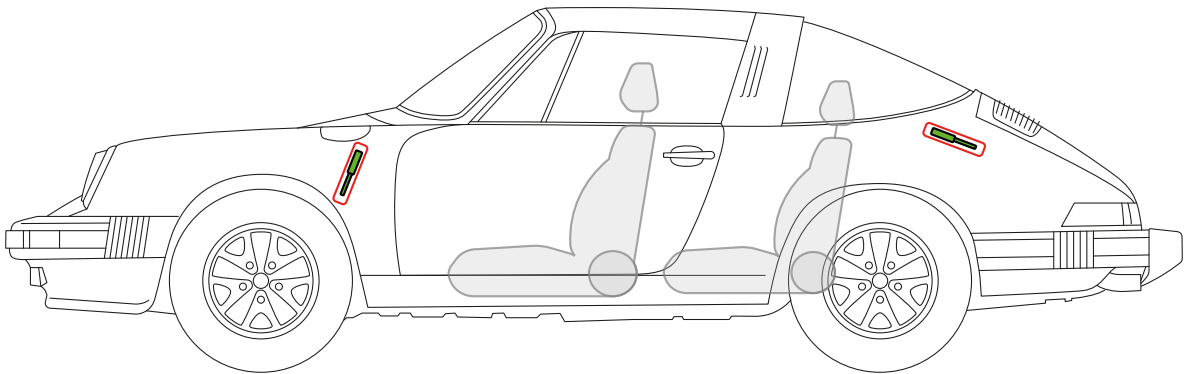
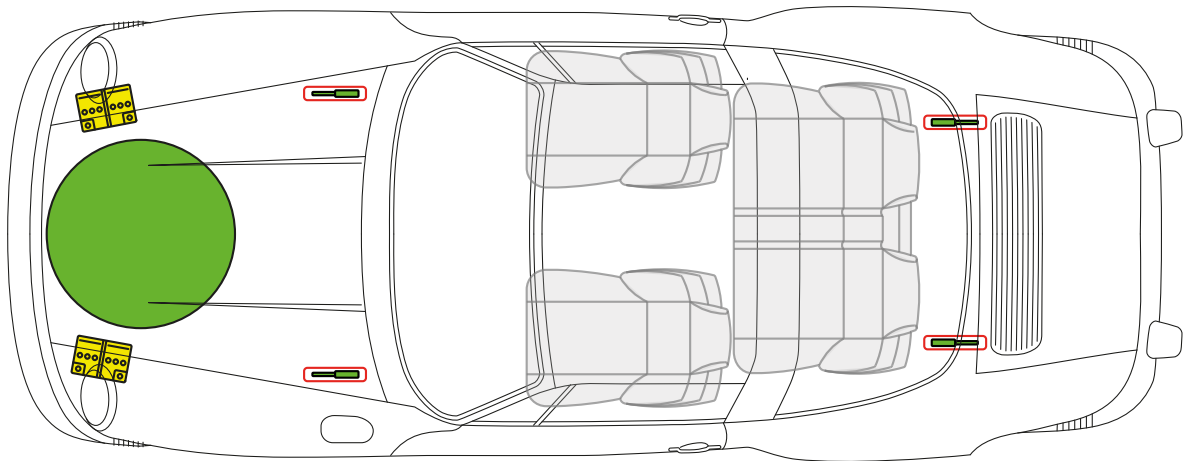

Batería

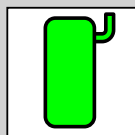

Depósito de combustible

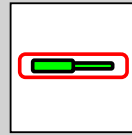

Amortiguador a gas



**Porsche AG, 911 G-Model, Cabriolet,
todos derivados,**

PORSCHE mod. 1983 hasta el mod. 1989

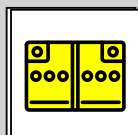
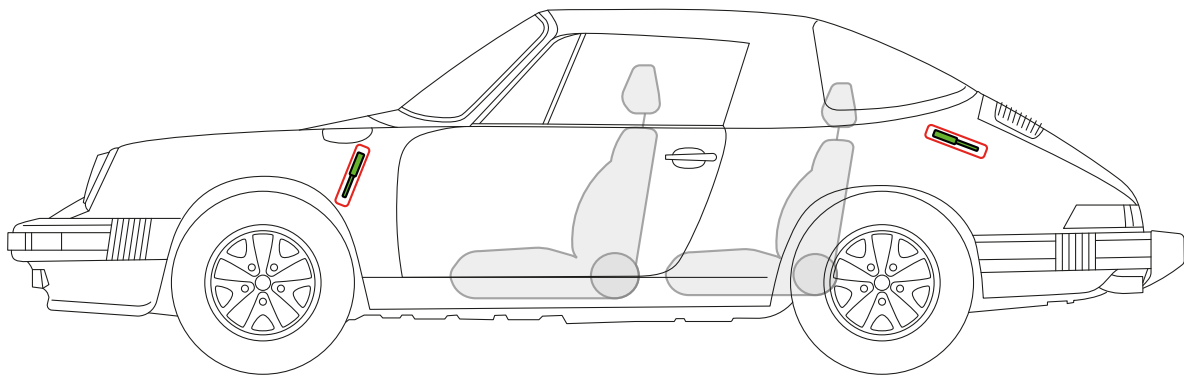
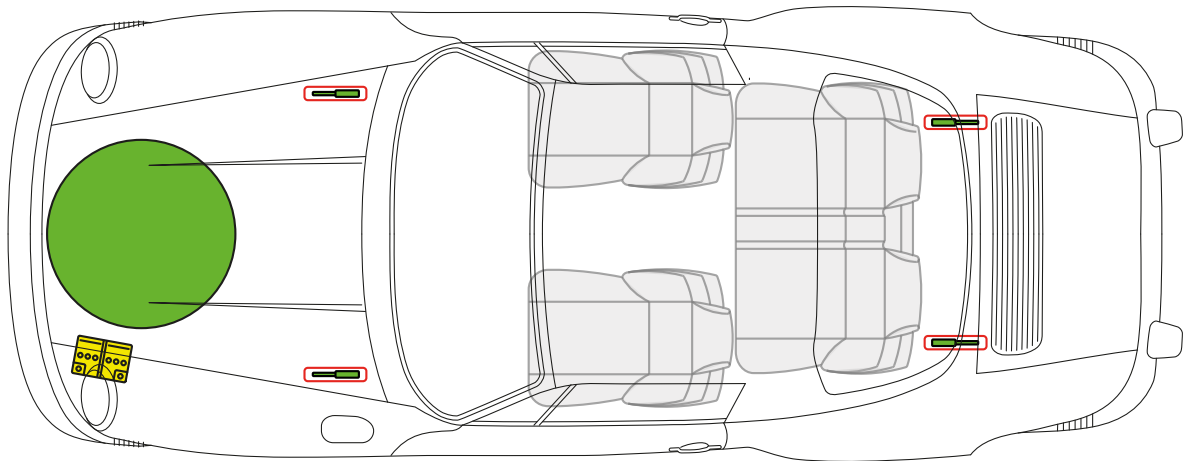

Batería

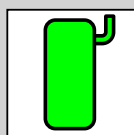

Depósito de combustible

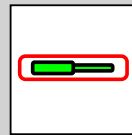

Amortiguador a gas



**Porsche AG, 911 G-Model Turbo (930), Coupé,
todos derivados,**

PORSCHE mod. 1974 hasta el mod. 1989

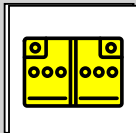
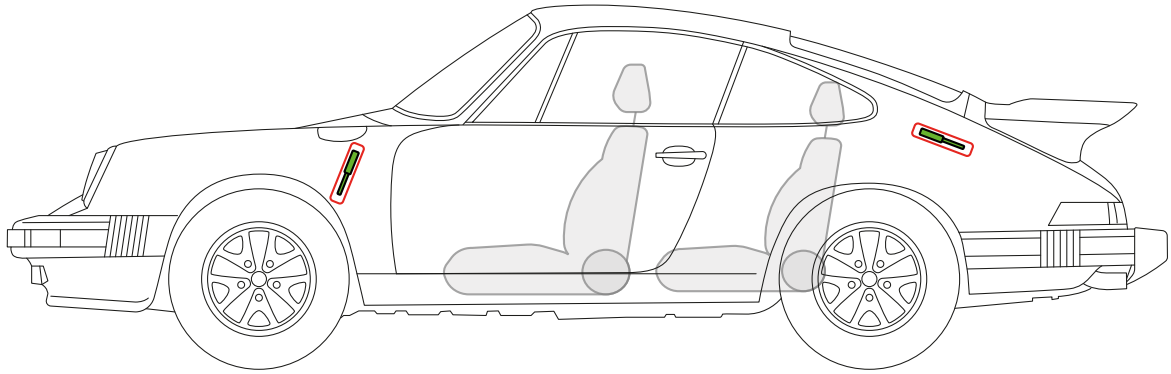
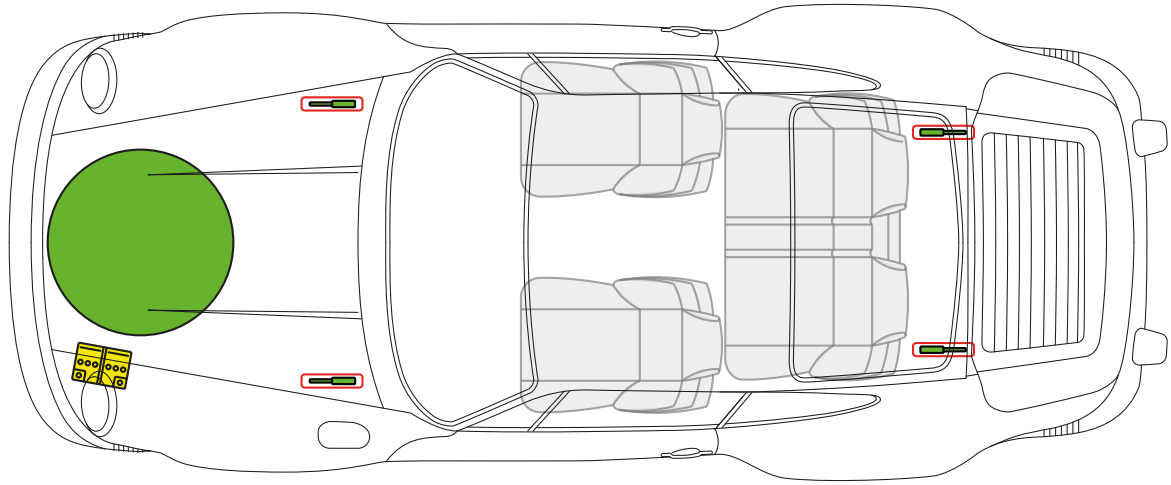

Batería

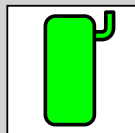

Depósito de
combustible

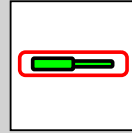

Amortiguador
a gas



**Porsche AG, 911 G-Model Turbo (930), Targa,
todos derivados,**

PORSCHE mod. 1986 hasta el mod. 1989

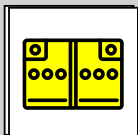
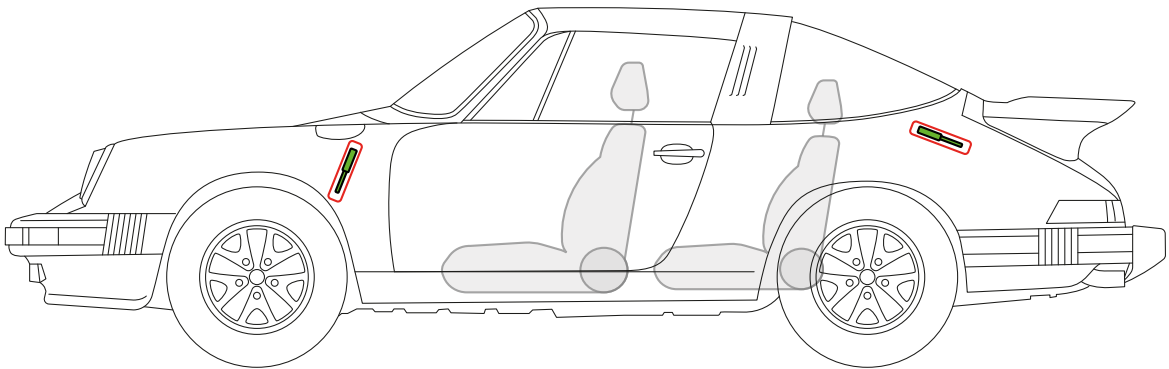
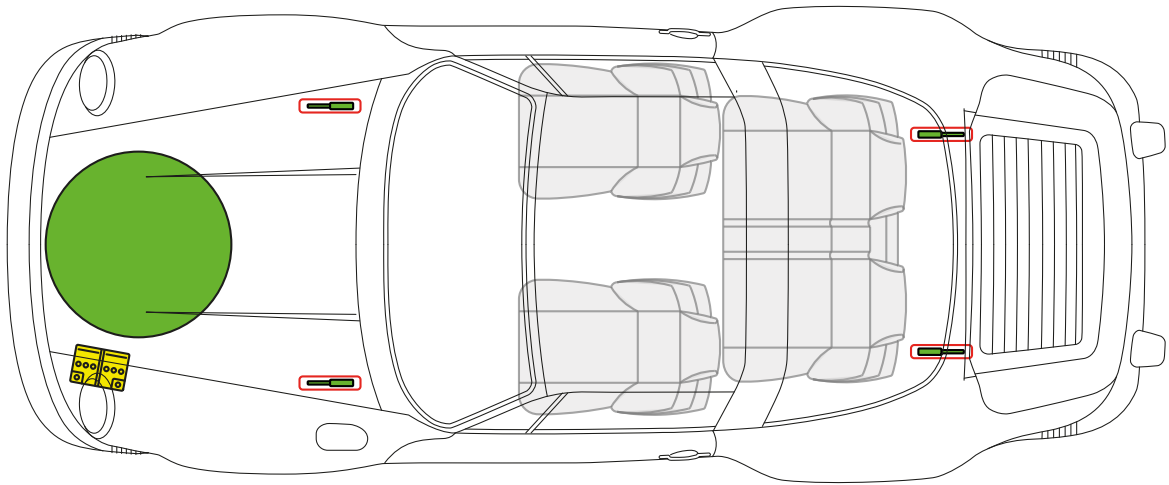
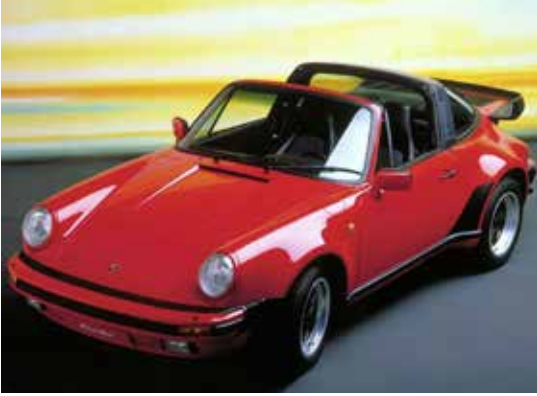

Batería

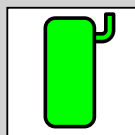

Depósito de
combustible

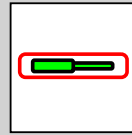

Amortiguador
a gas



**Porsche AG, 911 G-Model Turbo (930), Cabriolet,
todos derivados,**

PORSCHE mod. 1986 hasta el mod. 1989

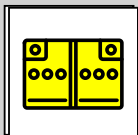
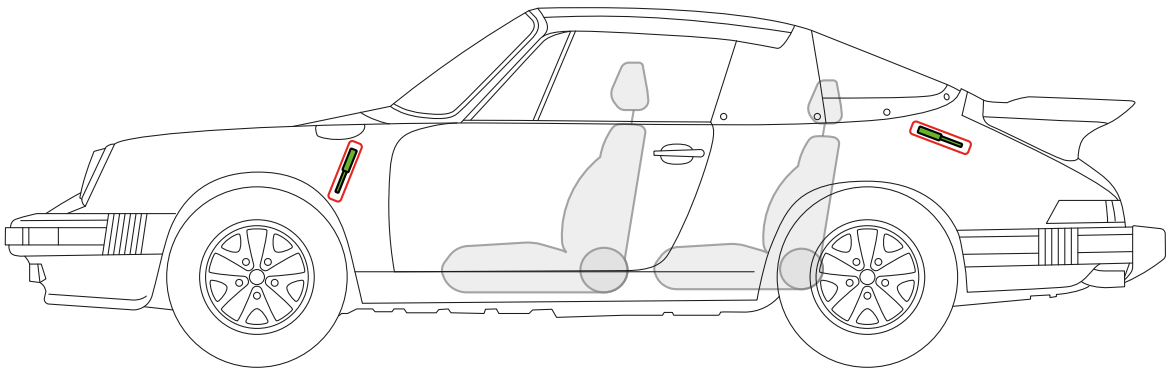
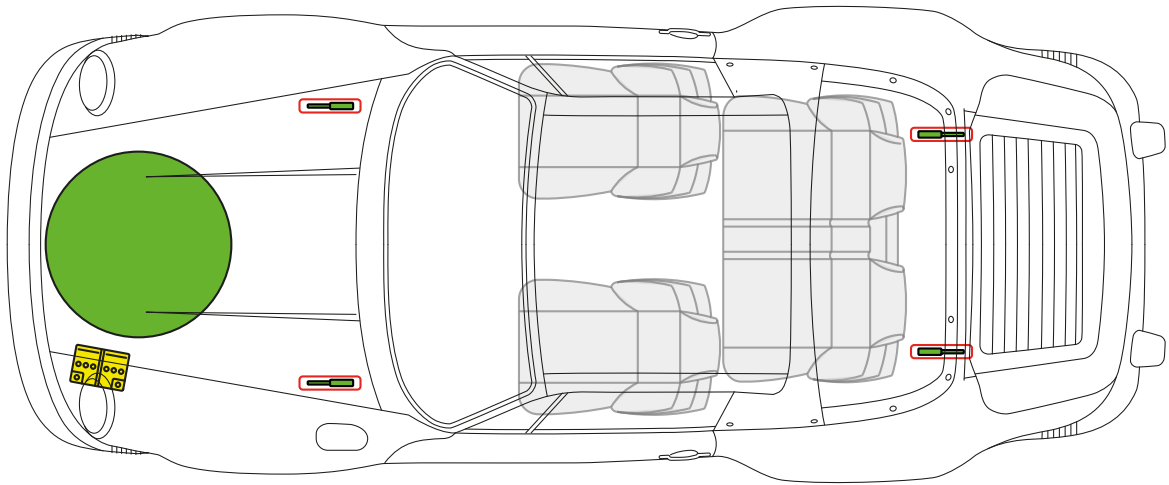

Batería

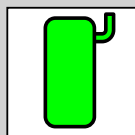

Depósito de
combustible

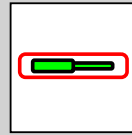

Amortiguador
a gas



**Porsche AG, 912, 912 E, Coupé,
todos derivados,**

PORSCHE mod. 1965 hasta el mod. 1969, mod. 1976 (912 E)

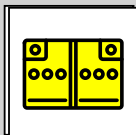
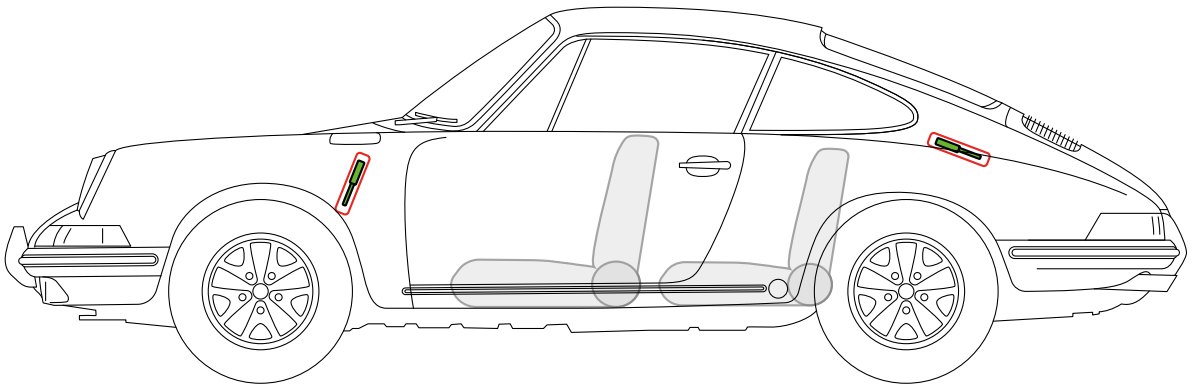
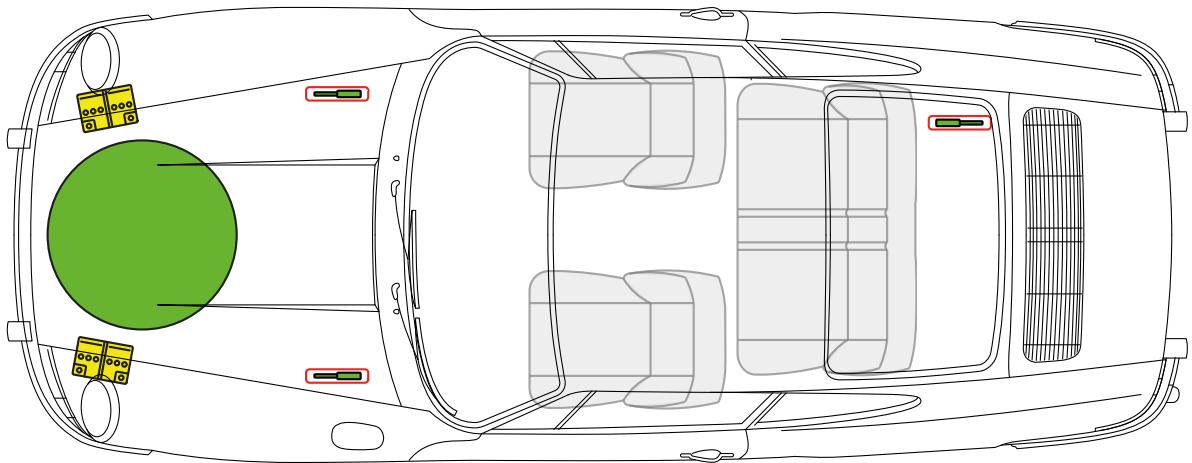

Batería

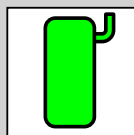

Depósito de
combustible

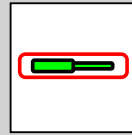

Amortiguador
a gas



**Porsche AG, 912, Targa,
todos derivados,
mod. 1965 hasta el mod. 1969**

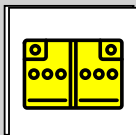
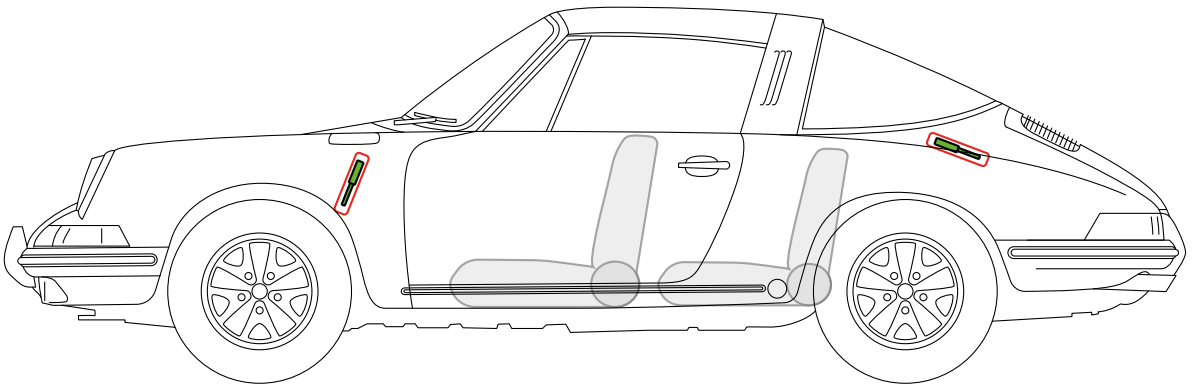
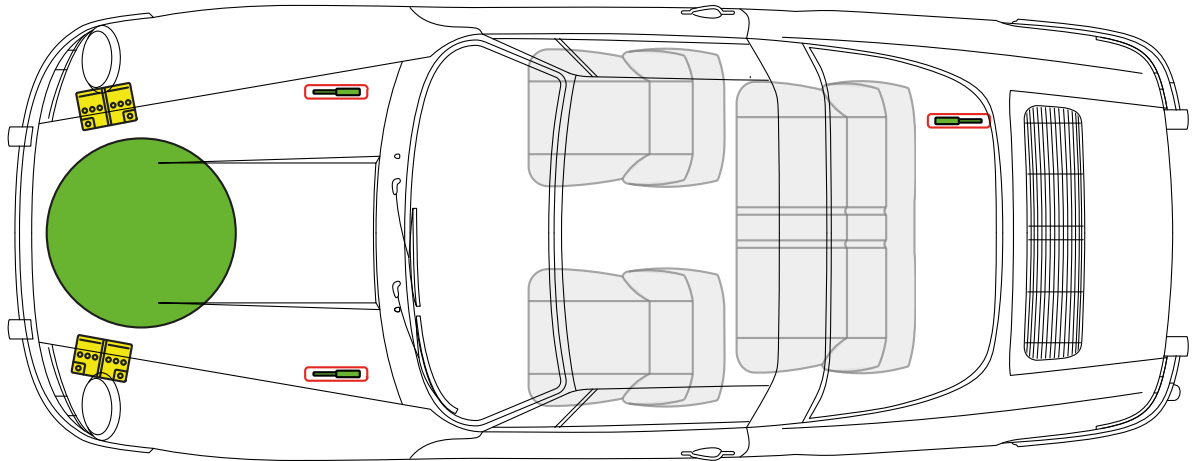

Batería

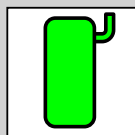

Depósito de combustible

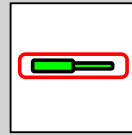

Amortiguador a gas



**Porsche AG, 914, Coupé,
todos derivados,
mod. 1970 hasta el mod. 1976**

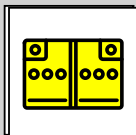
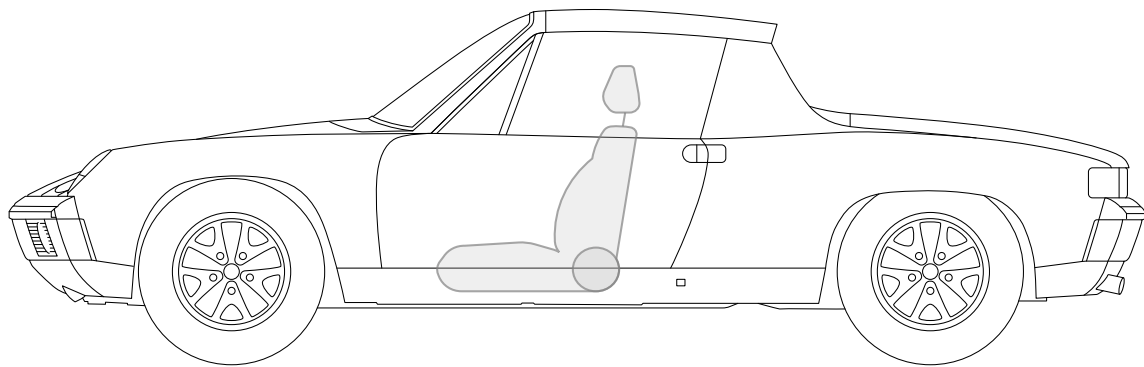
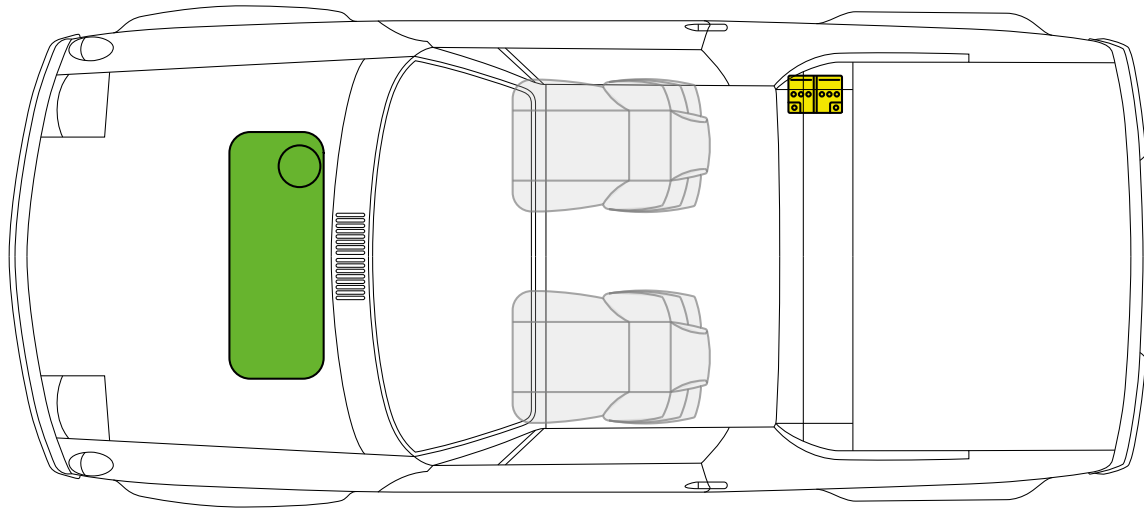

Batería

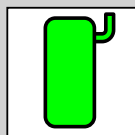

Depósito de combustible



**Porsche AG, 924, Coupé,
todos derivados,
mod. 1976 hasta el mod. 1988**

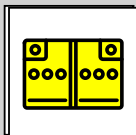
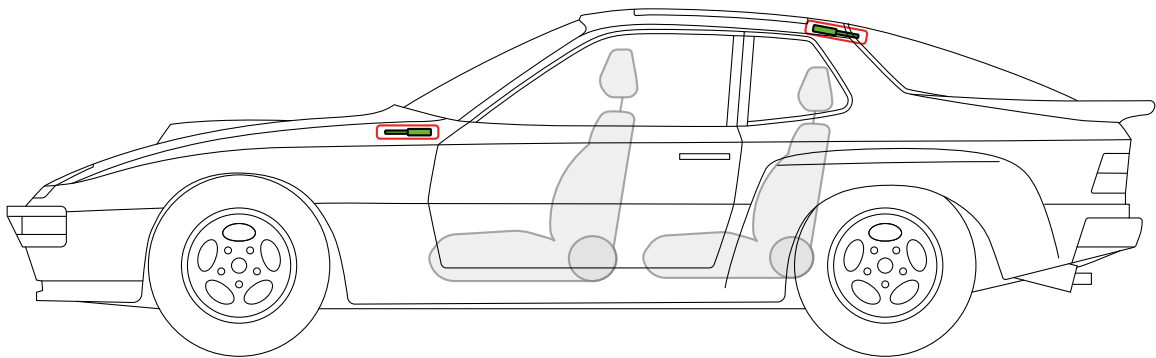
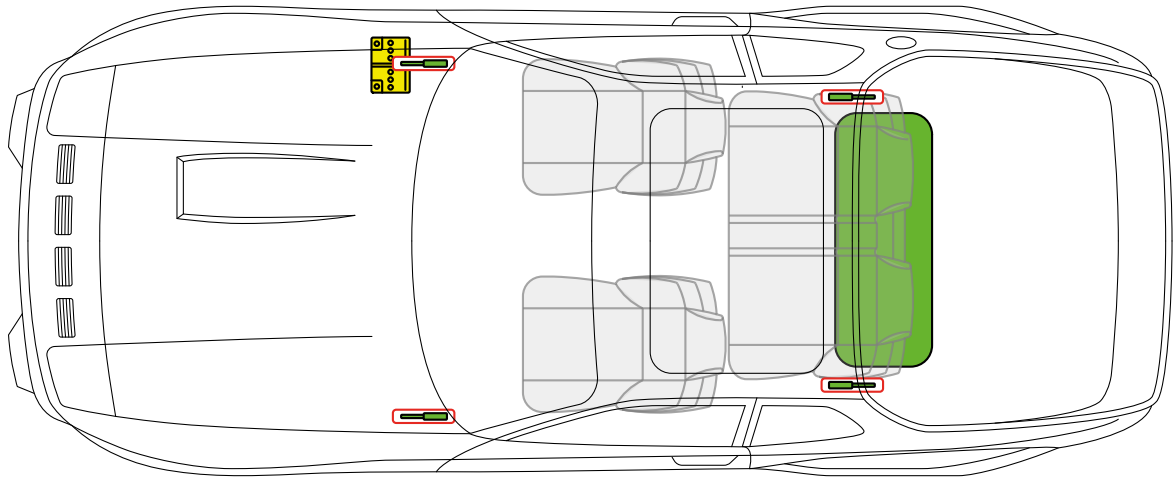

Batería

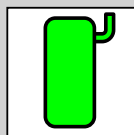

Depósito de
combustible

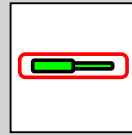

Amortiguador
a gas



**Porsche AG, 928, Coupé,
todos derivados,
mod. 1977 hasta el mod. 1995**

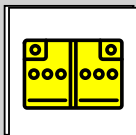
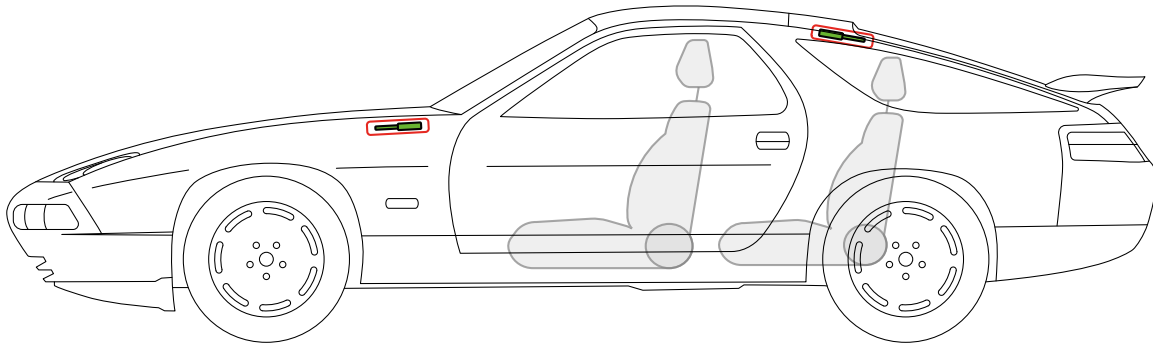
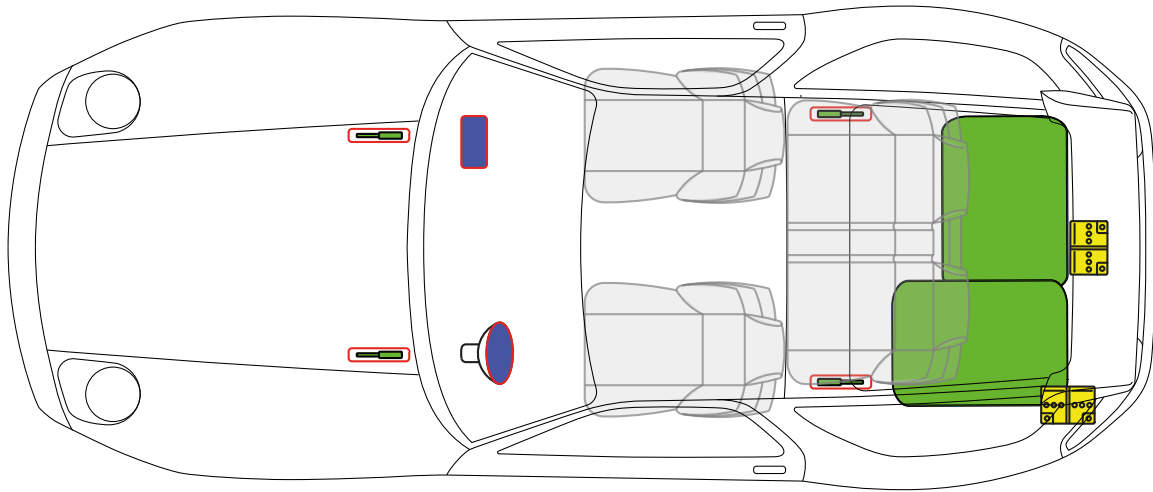

Batería

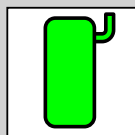

Depósito de combustible

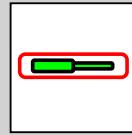

Amortiguador a gas



**Porsche AG, 944 Coupé, Targa,
todos derivados,
mod. 1982 hasta el mod. 1991**

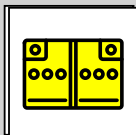
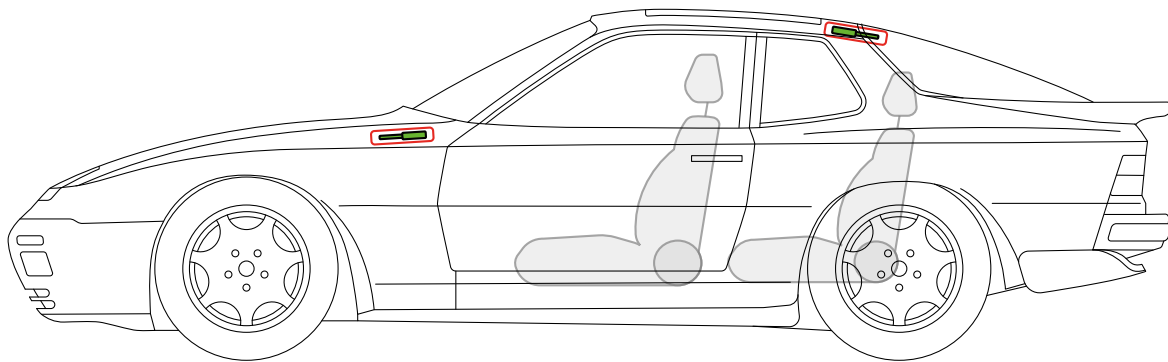
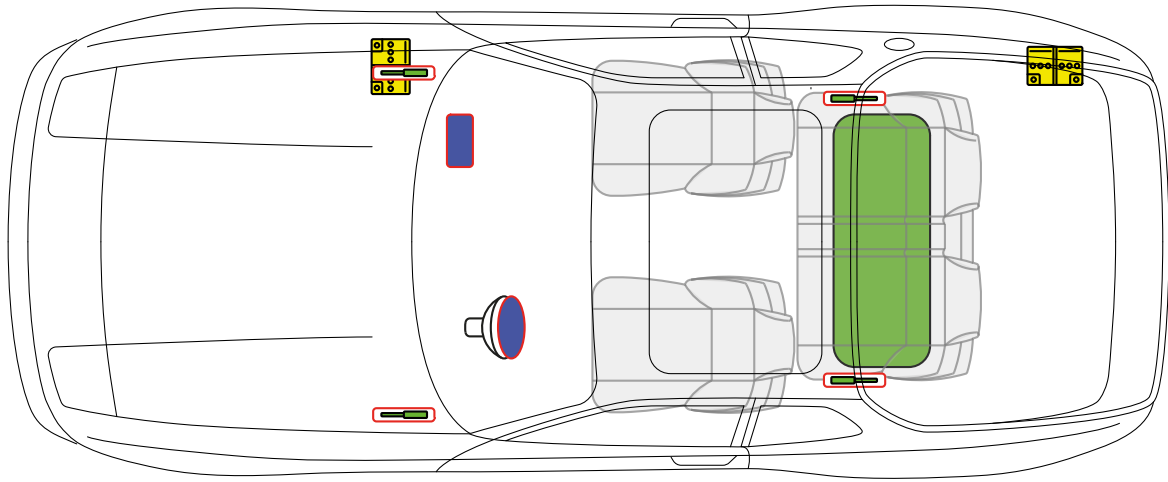
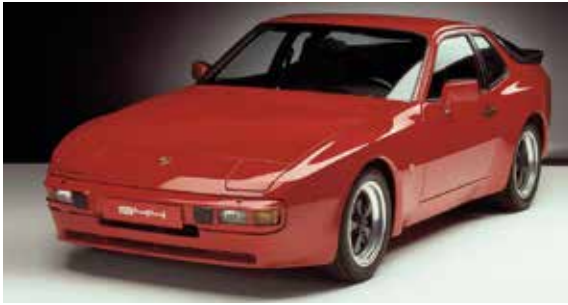

Batería

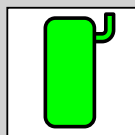

Depósito de combustible

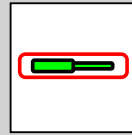

Amortiguador a gas

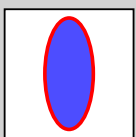

Airbag



**Porsche AG, 944, Cabriolet,
todos derivados,
mod. 1989 hasta el mod. 1991**

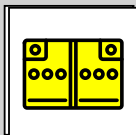
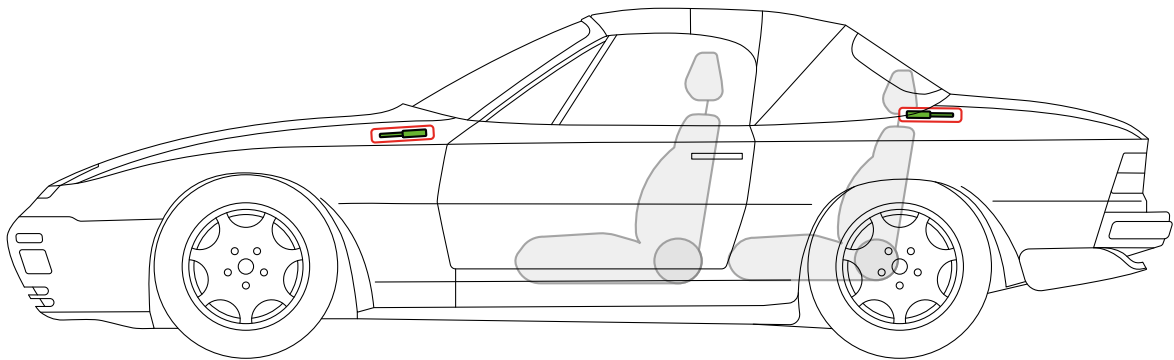
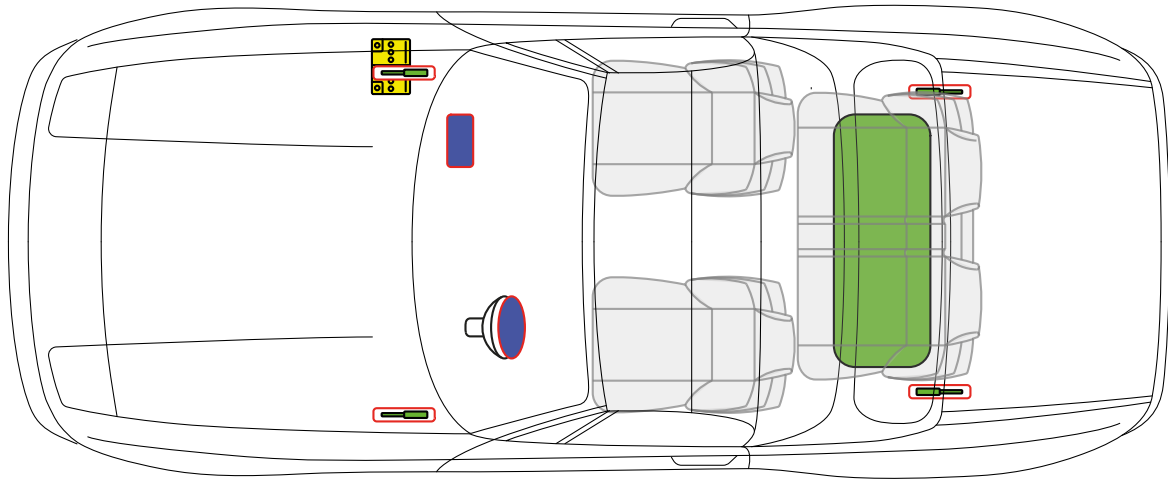

Batería

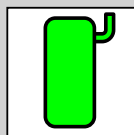

Depósito de combustible

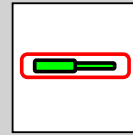

Amortiguador a gas

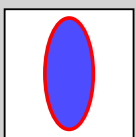

Airbag



**Porsche AG, 959, Coupé,
todos derivados,
mod. 1986 hasta el mod. 1988**

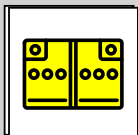
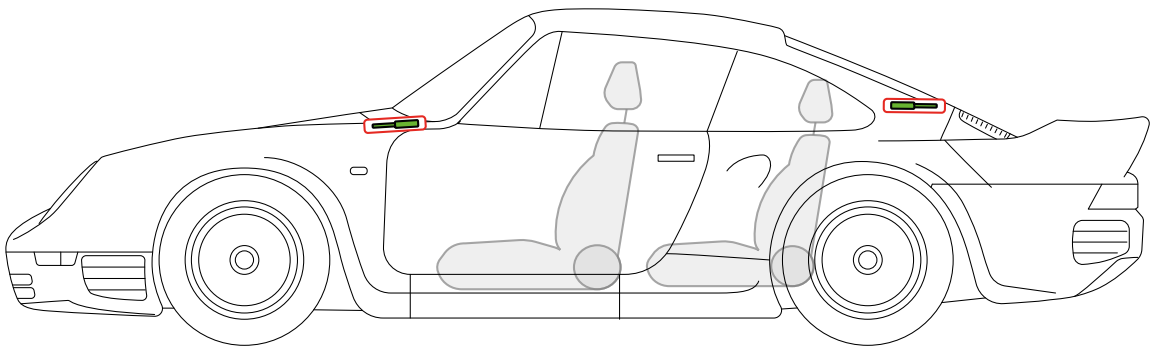
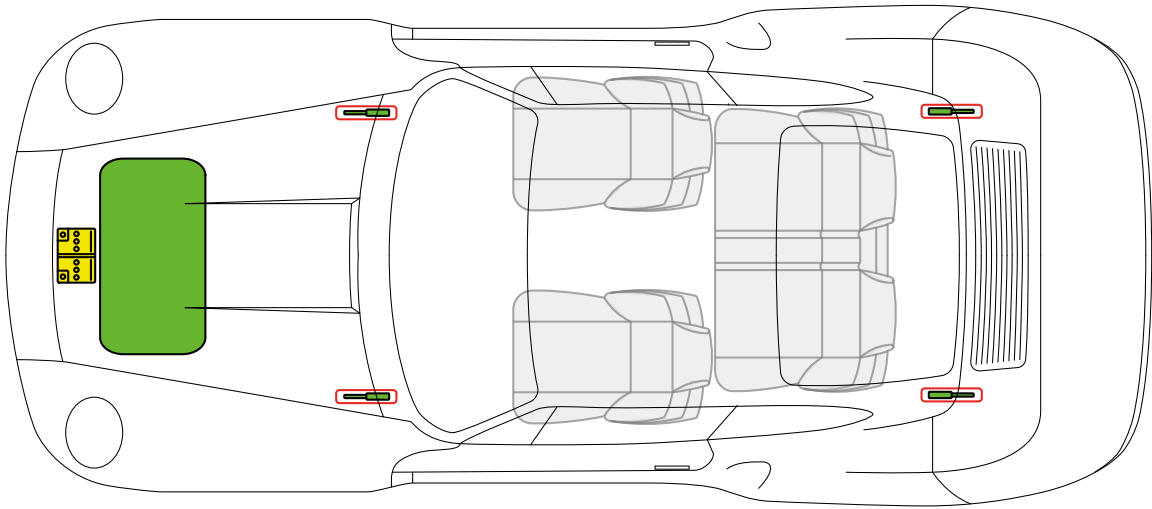

Batería

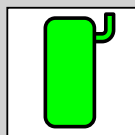

Depósito de
combustible

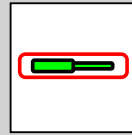

Amortiguador
a gas



**Porsche AG, 964, Coupé,
todos derivados,
mod. 1989 hasta el mod. 1994**

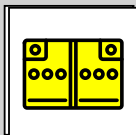
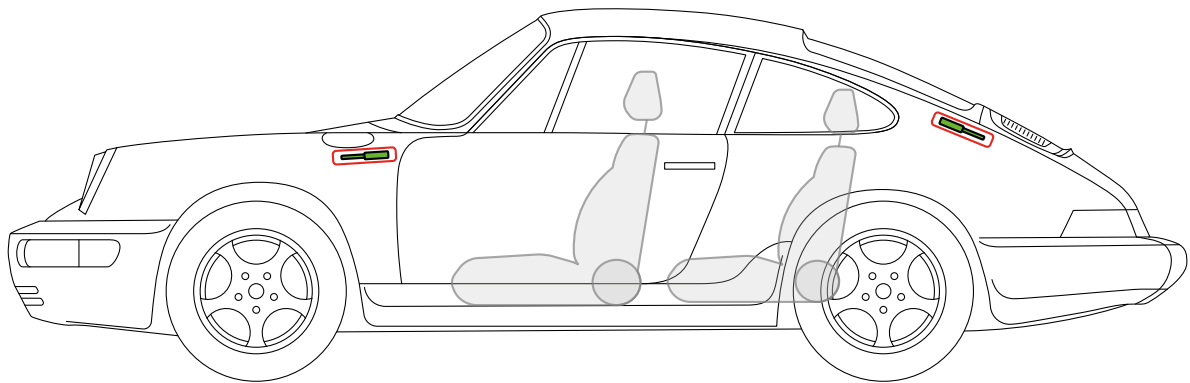
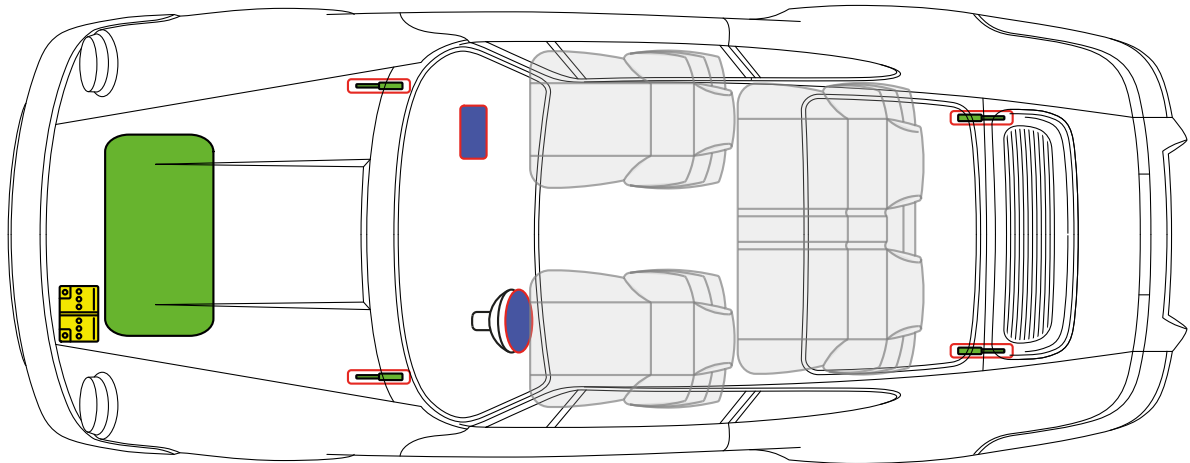
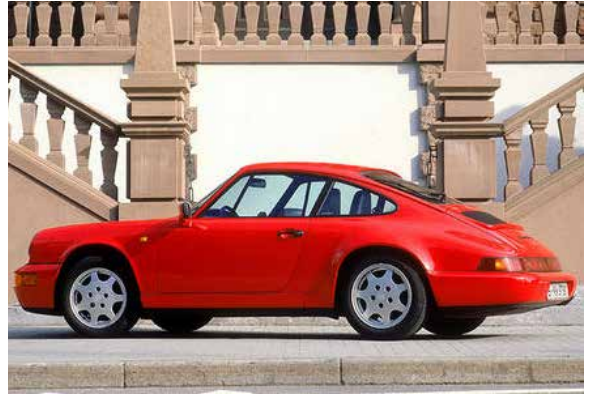

Batería

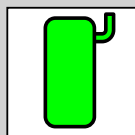

Depósito de
combustible

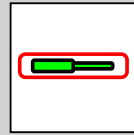

Amortiguador
a gas

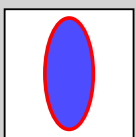

Airbag



**Porsche AG, 964, Targa,
todos derivados,
mod. 1990 hasta el mod. 1994**

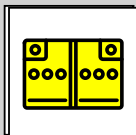
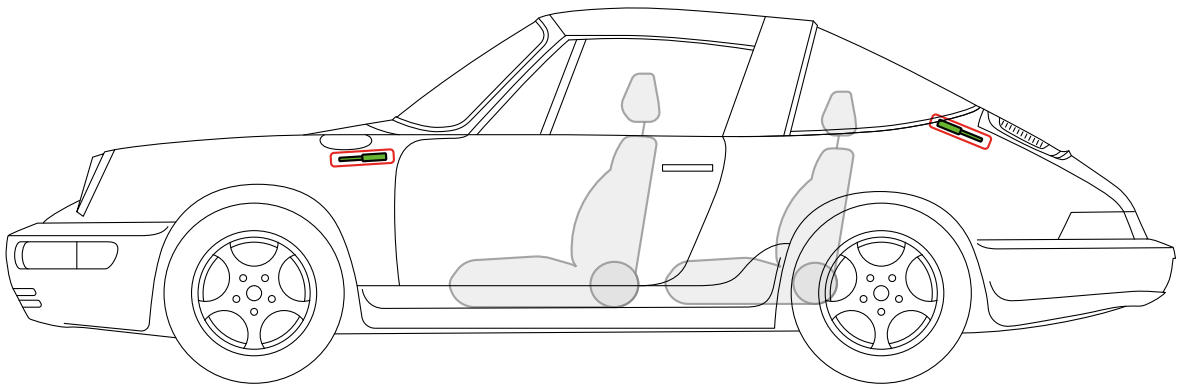
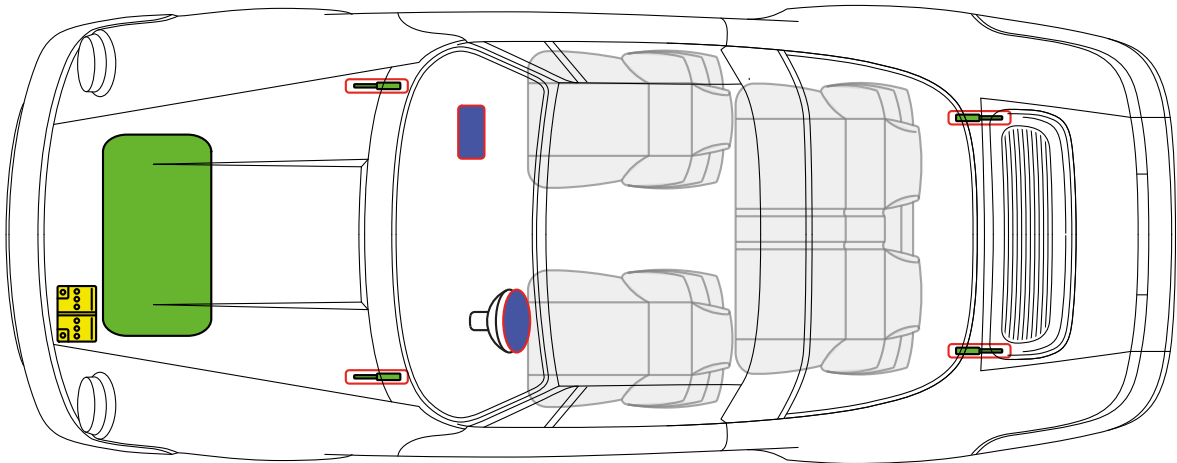

Batería

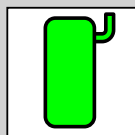

Depósito de combustible

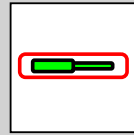

Amortiguador a gas

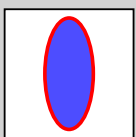

Airbag



**Porsche AG, 964, Cabriolet, Speedster,
todos derivados,**

PORSCHE mod. 1990 hasta el mod. 1994

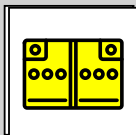
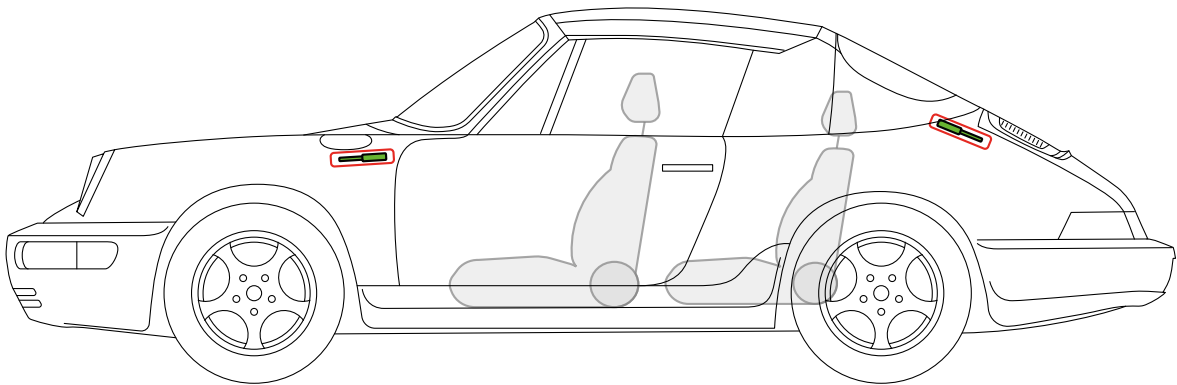
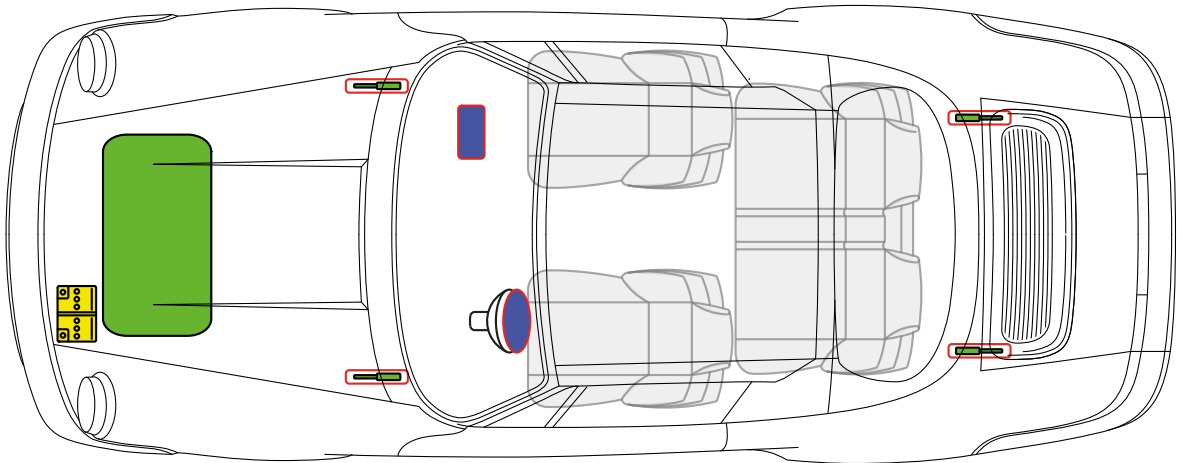

Batería

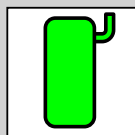

Depósito de combustible

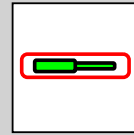

Amortiguador a gas

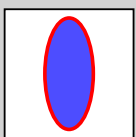

Airbag



**Porsche AG, 964, Coupé, Turbo,
todos derivados,
mod. 1990 hasta el mod. 1994**

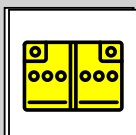
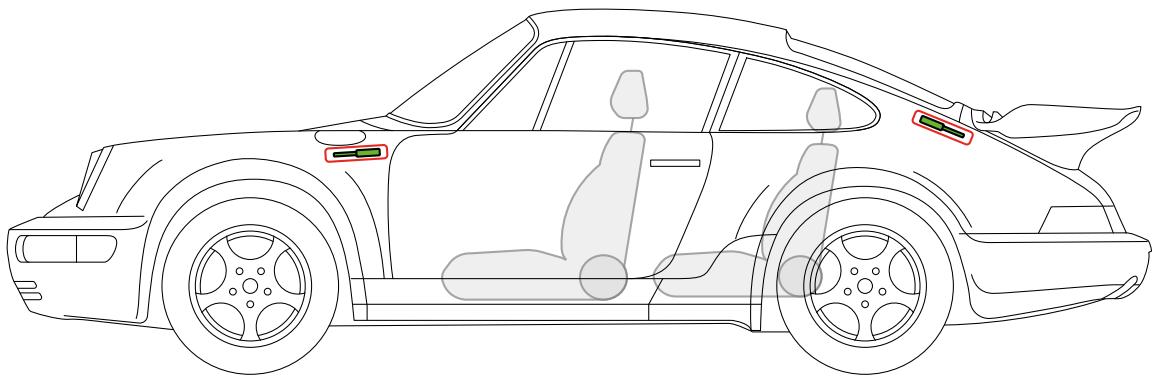
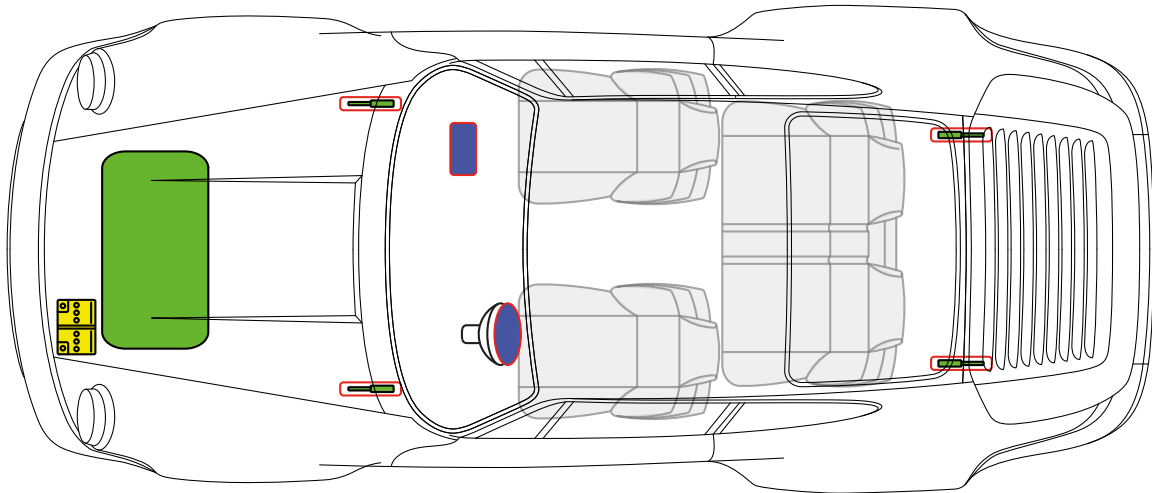
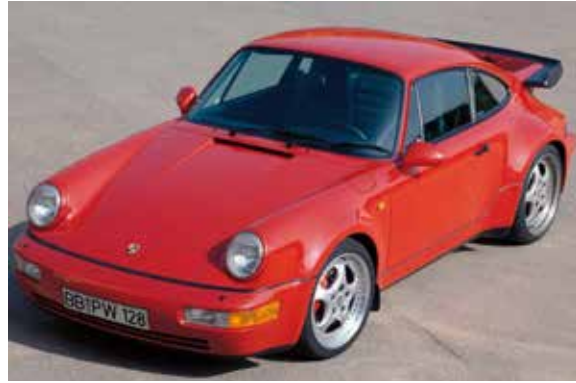

Batería

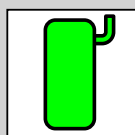

Depósito de
combustible

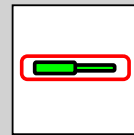

Amortiguador
a gas

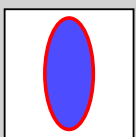

Airbag



**Porsche AG, 968, Coupé,
todos derivados,
mod. 1991 hasta el mod. 1995**

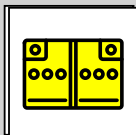
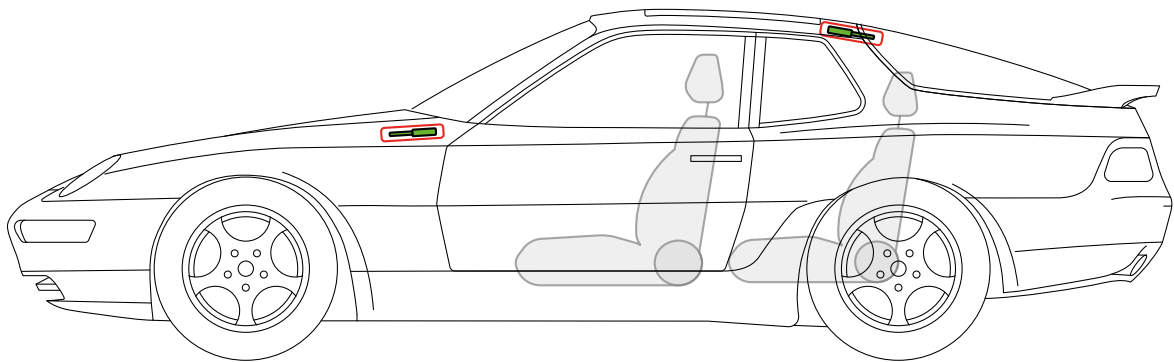
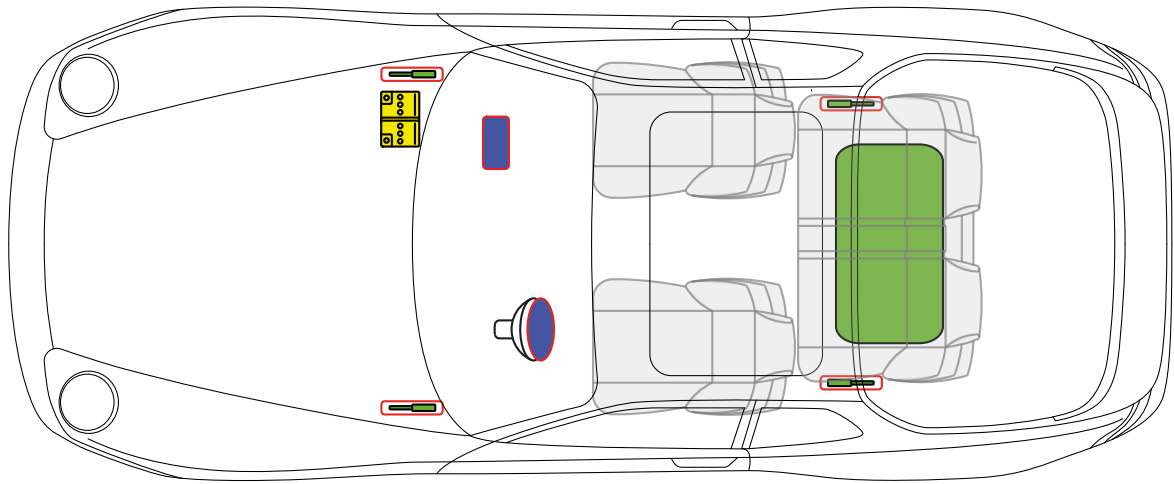

Batería

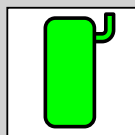

Depósito de combustible

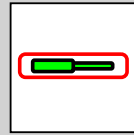

Amortiguador a gas

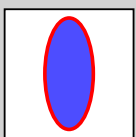

Airbag



**Porsche AG, 968, Coupé,
todos derivados,
mod. 1991 hasta el mod. 1995**

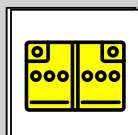
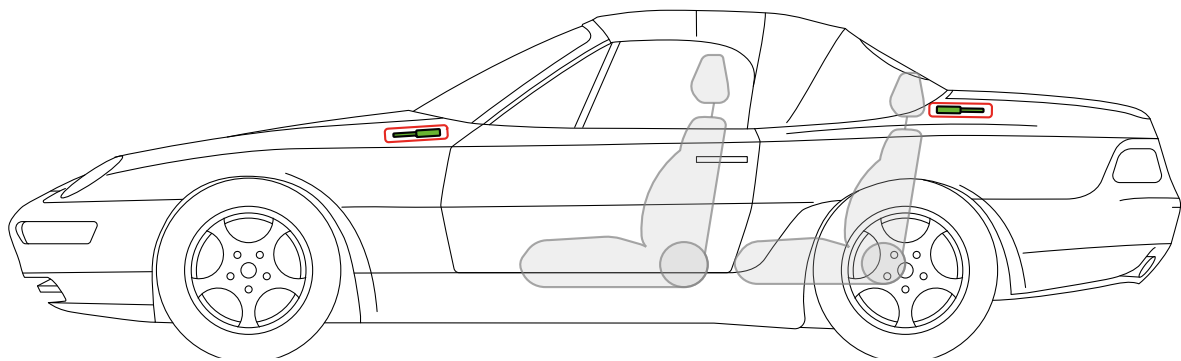
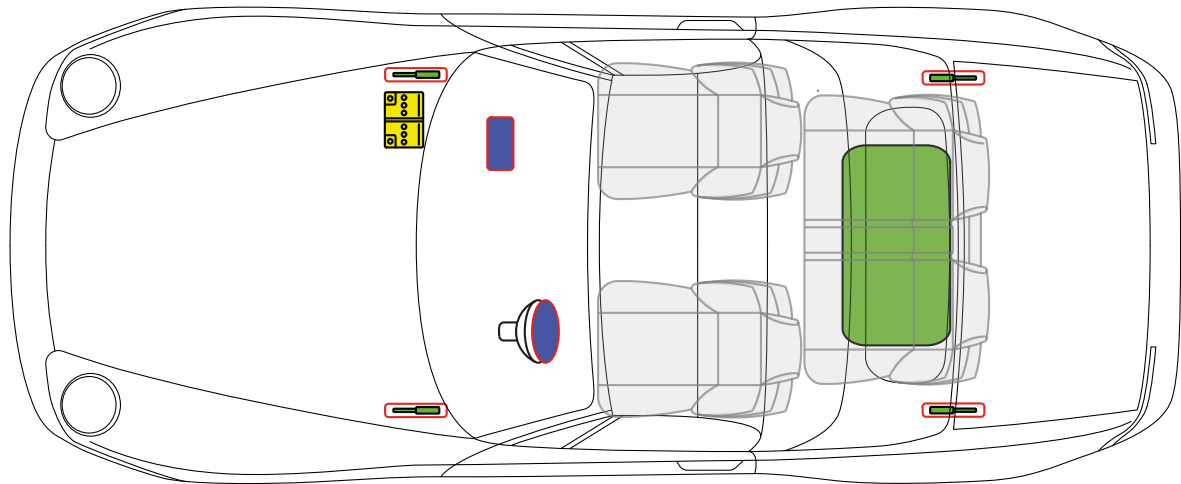

Batería

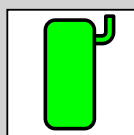

Depósito de combustible

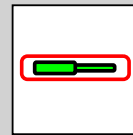

Amortiguador a gas

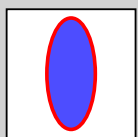

Airbag



**Porsche AG, 993, Coupé,
todos derivados,
mod. 1994 hasta el mod. 1998**

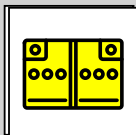
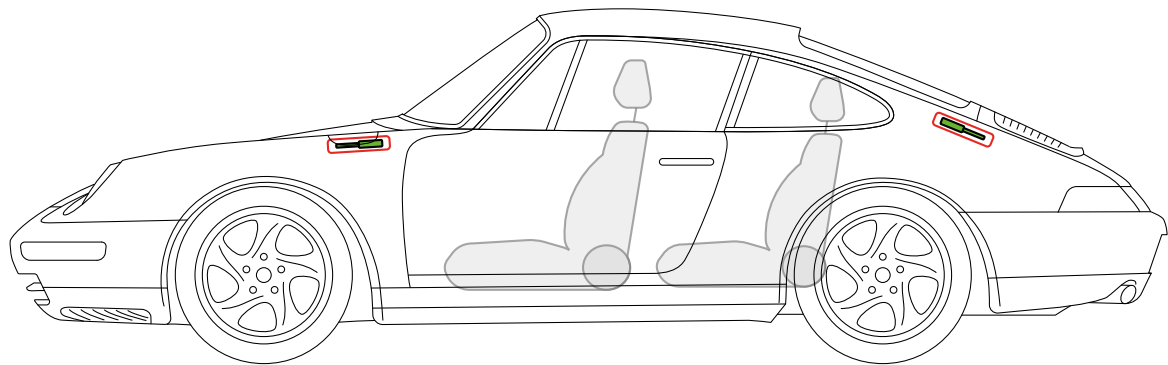
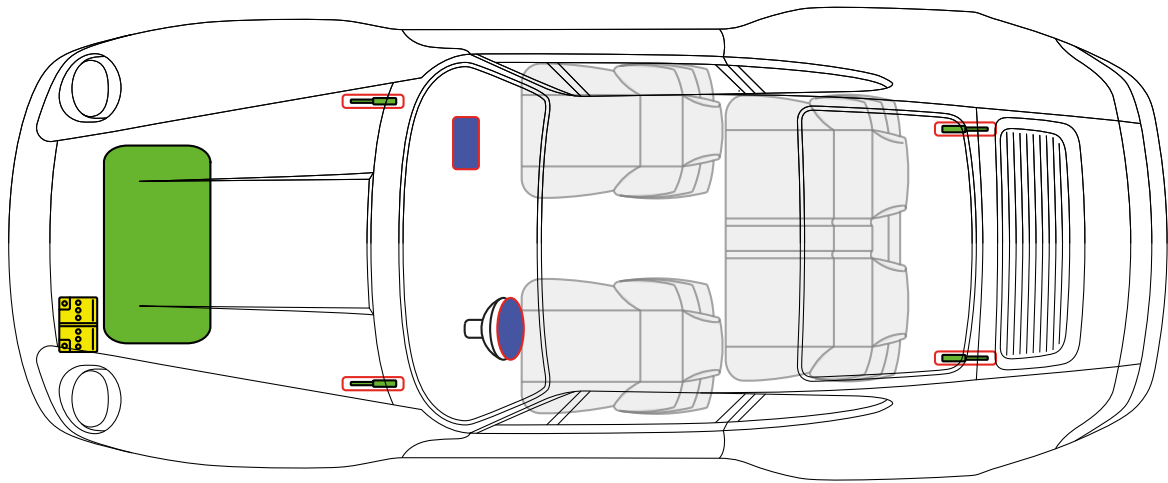

Batería

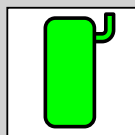

Depósito de combustible

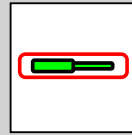

Amortiguador a gas

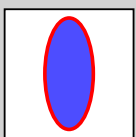

Airbag



**Porsche AG, 993, Targa,
todos derivados,
mod. 1994 hasta el mod. 1998**

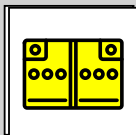
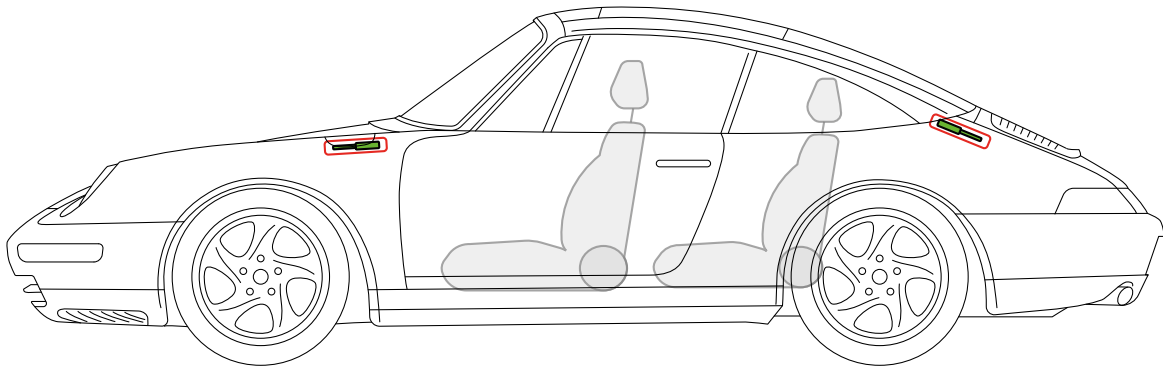
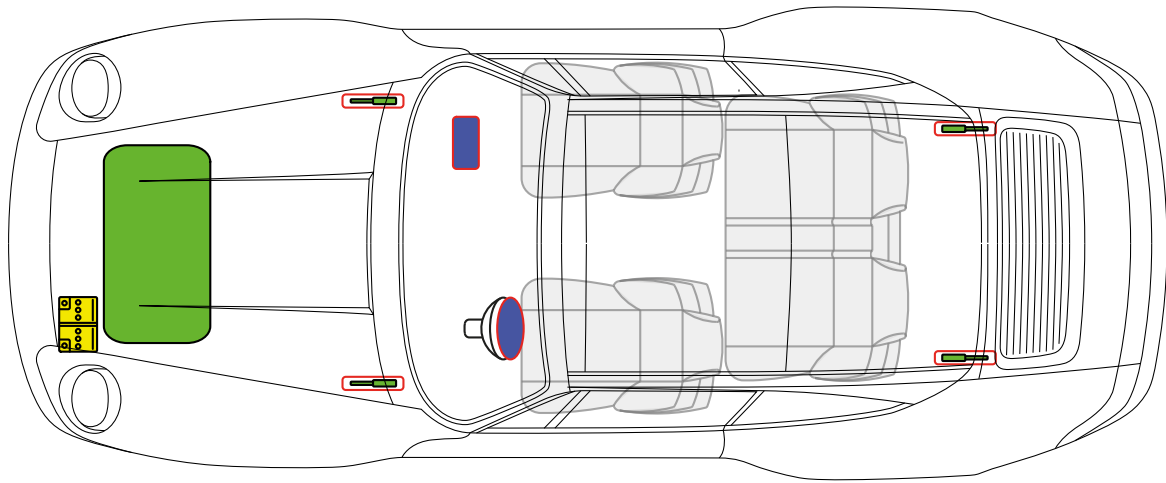

Batería

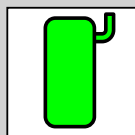

Depósito de
combustible

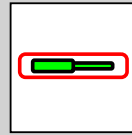

Amortiguador
a gas

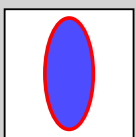

Airbag



Porsche AG, 993, Cabriolet,
todos derivados,
mod. 1994 hasta el mod. 1998

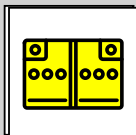
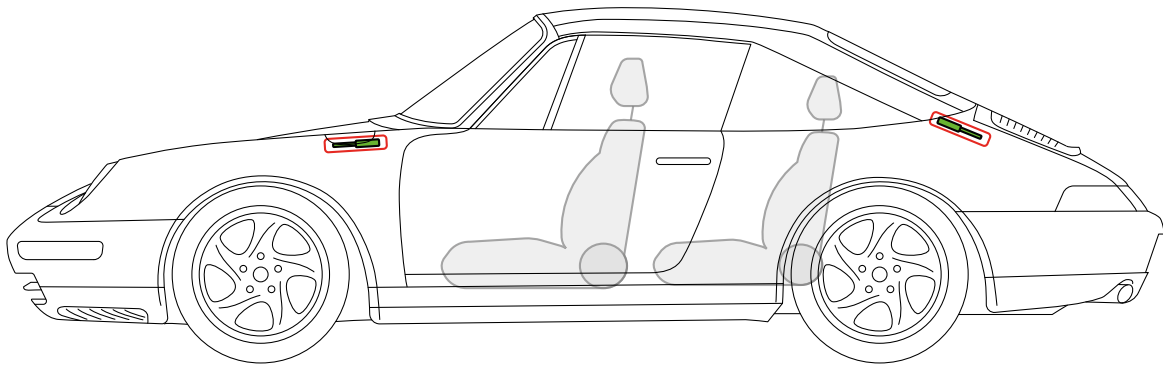
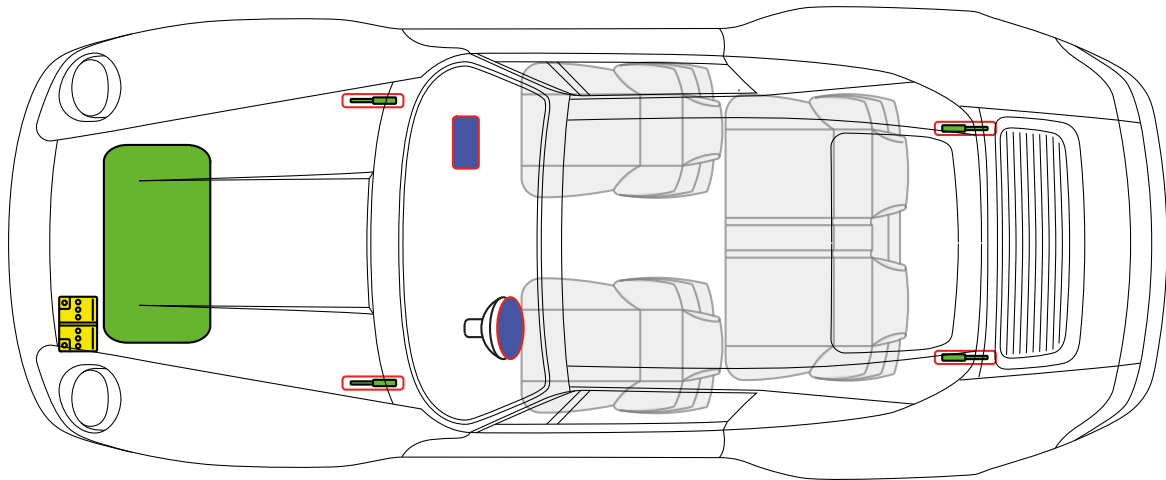

Batería

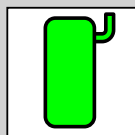

Depósito de combustible

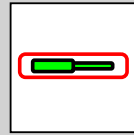

Amortiguador a gas

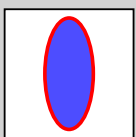

Airbag



**Porsche AG, 986, Boxster, Cabriolet,
todos derivados,**

PORSCHE mod. 1997 hasta el mod. 2004

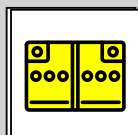
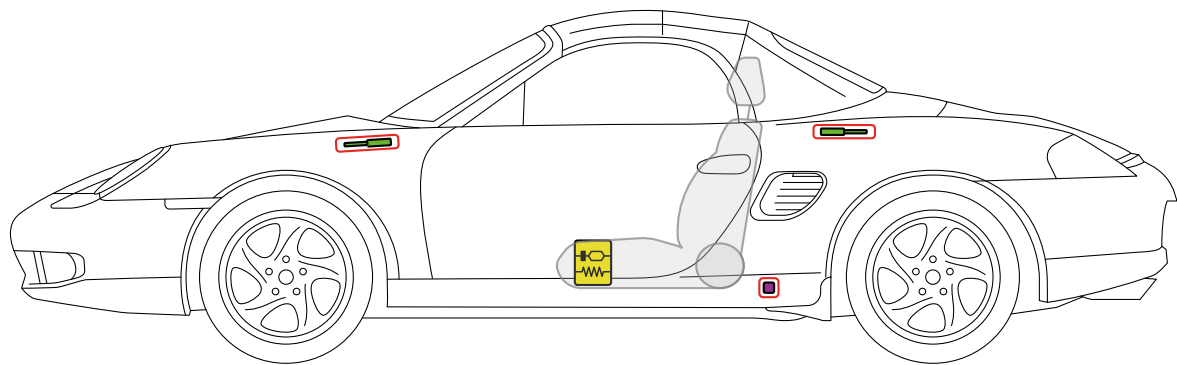
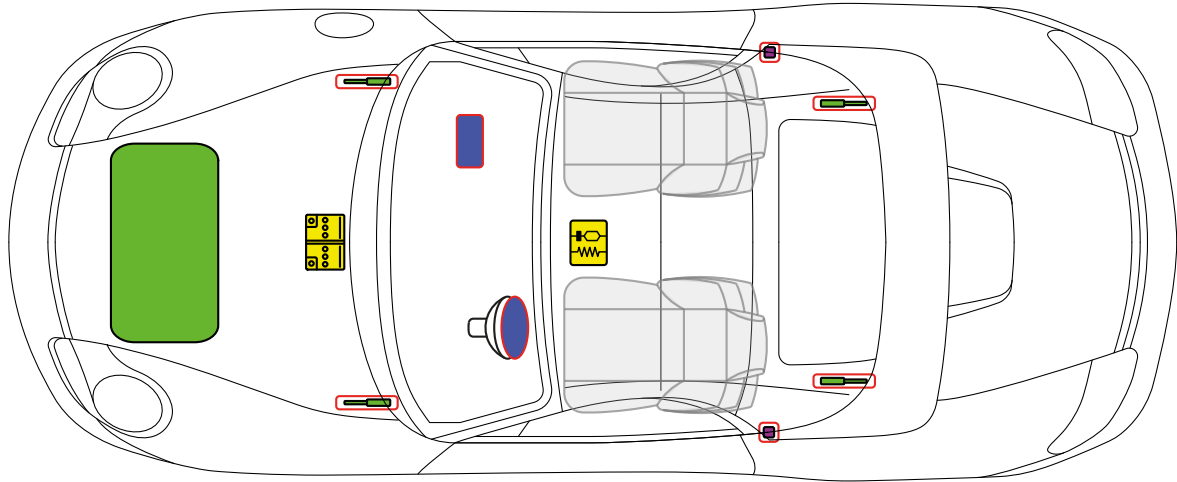

Batería

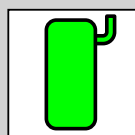

Depósito de combustible

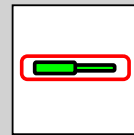

Amortiguador a gas

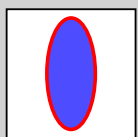

Airbag

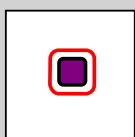

Pretensor del cinturón de seguridad

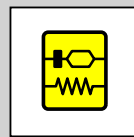

SRS-Unidad de control



**Porsche AG, 996, Coupé,
todos derivados,
mod. 1998 hasta el mod. 2005**

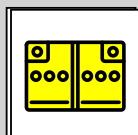
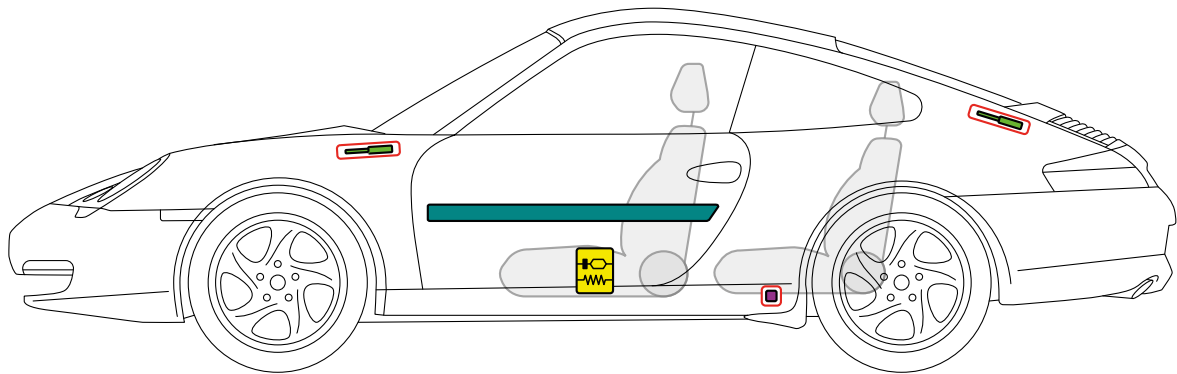
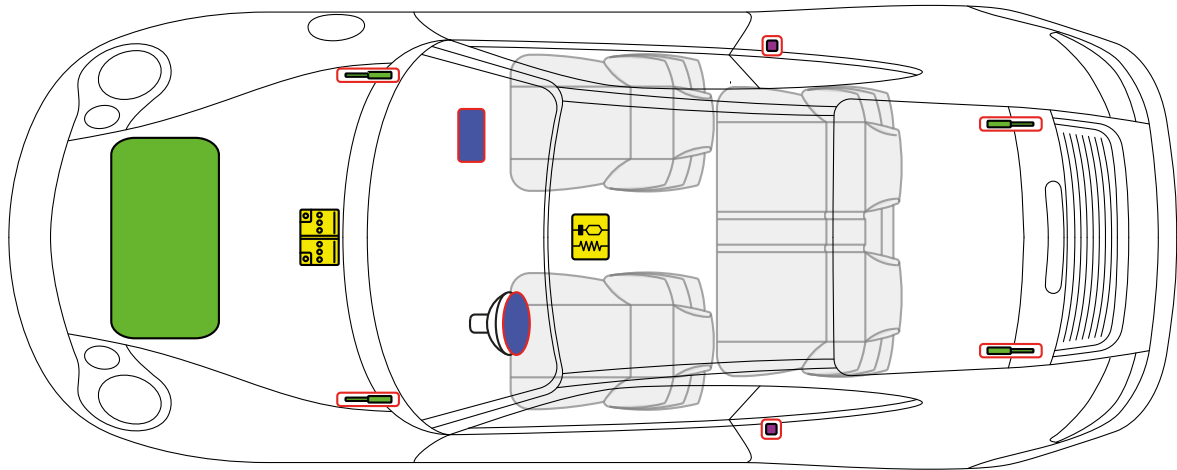
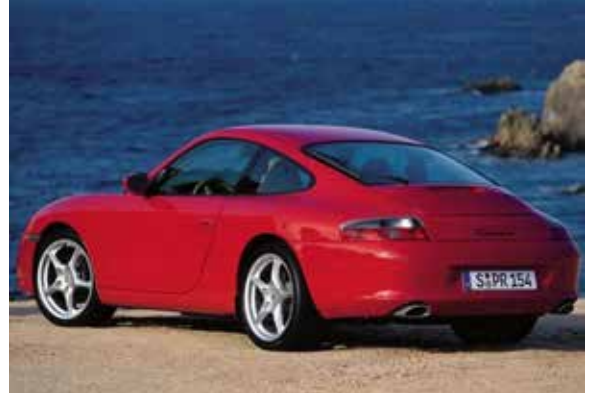

Batería

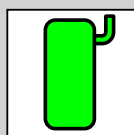

Depósito de combustible

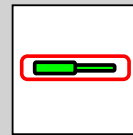

Amortiguador a gas

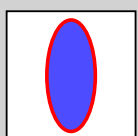

Airbag

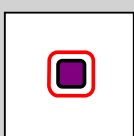

Pretensor del cinturón de seguridad

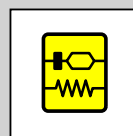

SRS-Unidad de control

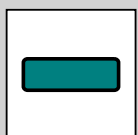

Refuerzo de la carrocería



**Porsche AG, 996, Targa,
 todos derivados,
 mod. 1998 hasta el mod. 2005**

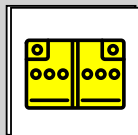
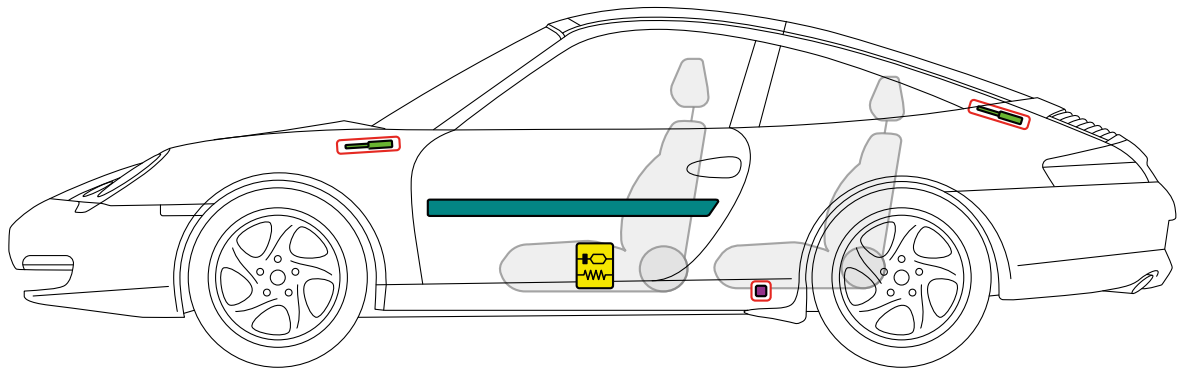
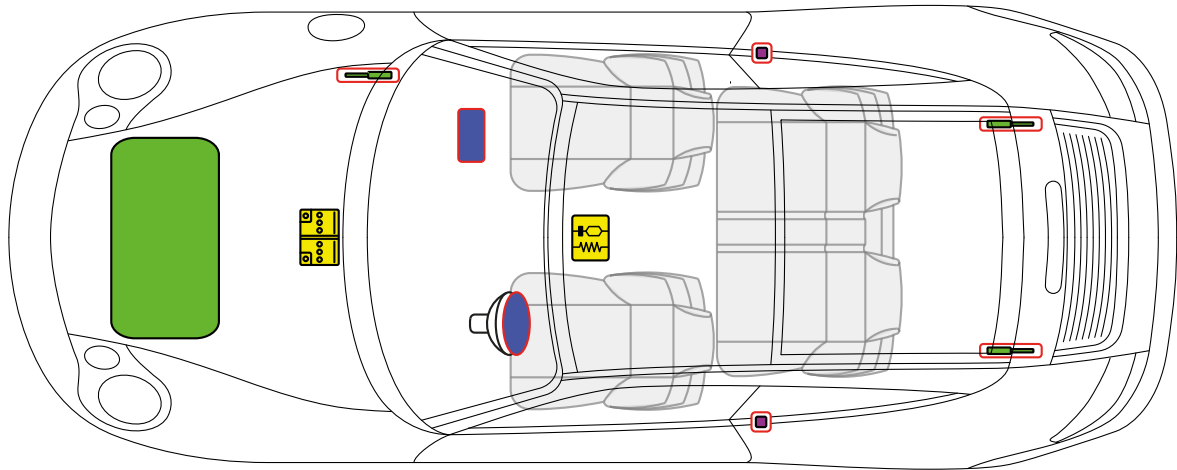

Batería

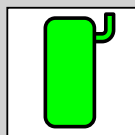

Depósito de combustible

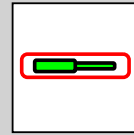

Amortiguador a gas

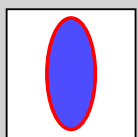

Airbag

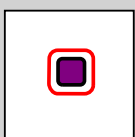

Pretensor del cinturón de seguridad

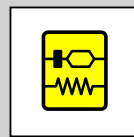

SRS-Unidad de control

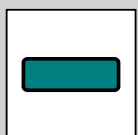

Refuerzo de la carrocería



**Porsche AG, 996, Cabriolet,
todos derivados,
mod. 1998 hasta el mod. 2005**

PORSCHE

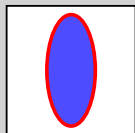
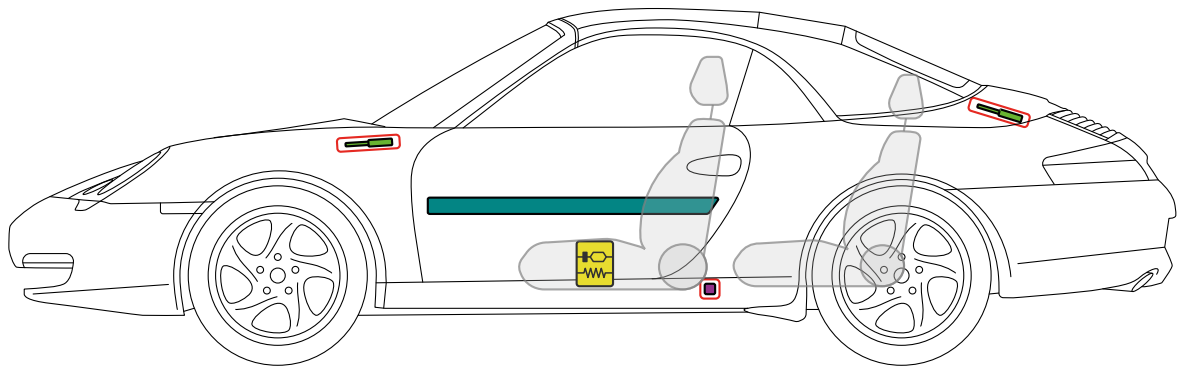
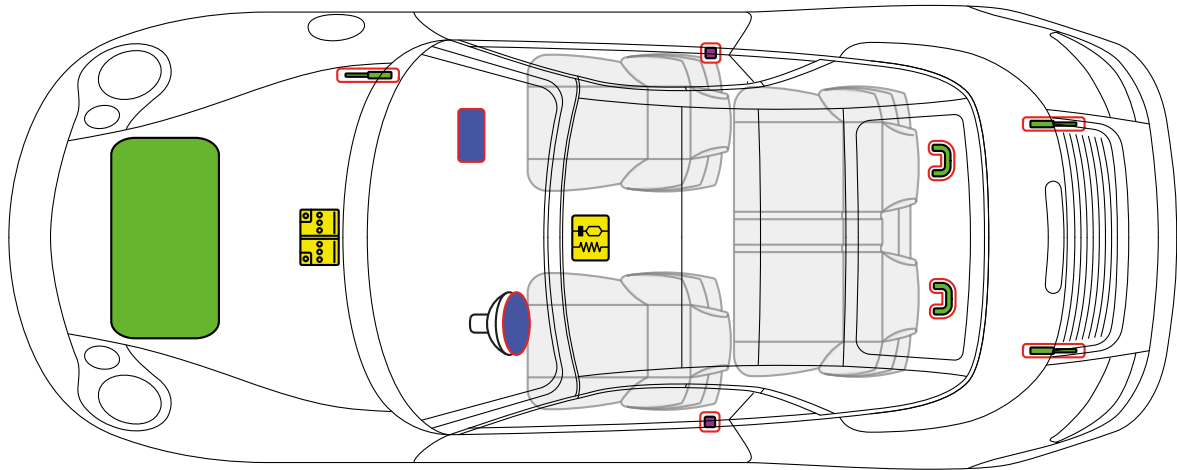

Airbag

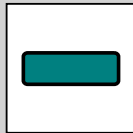

Refuerzo de la carrocería

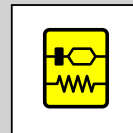

Unidad de control

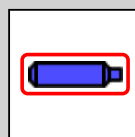

Generador de gas

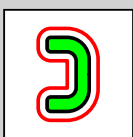

Protección antivuelco

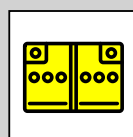

Batería



Pretensor del cinturón de seguridad

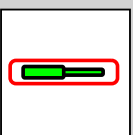

Amortiguador a gas

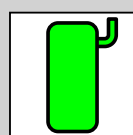

Depósito de combustible



**Porsche AG, 980, Carrera GT, Cabriolet,
todos derivados,**

PORSCHE mod. 2003 hasta el mod. 2006

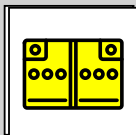
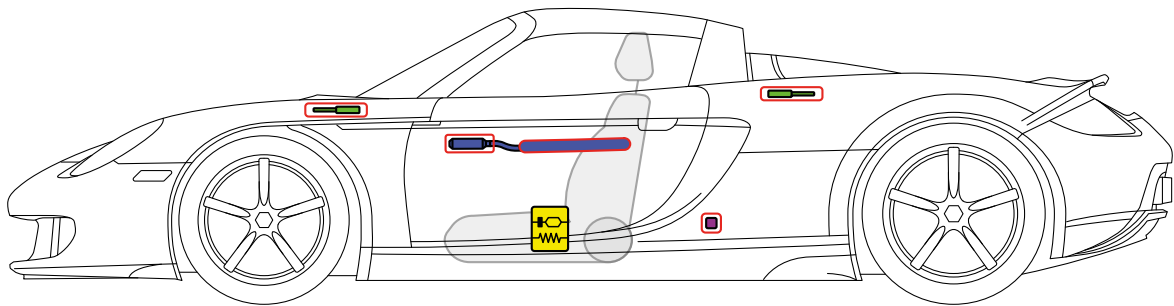
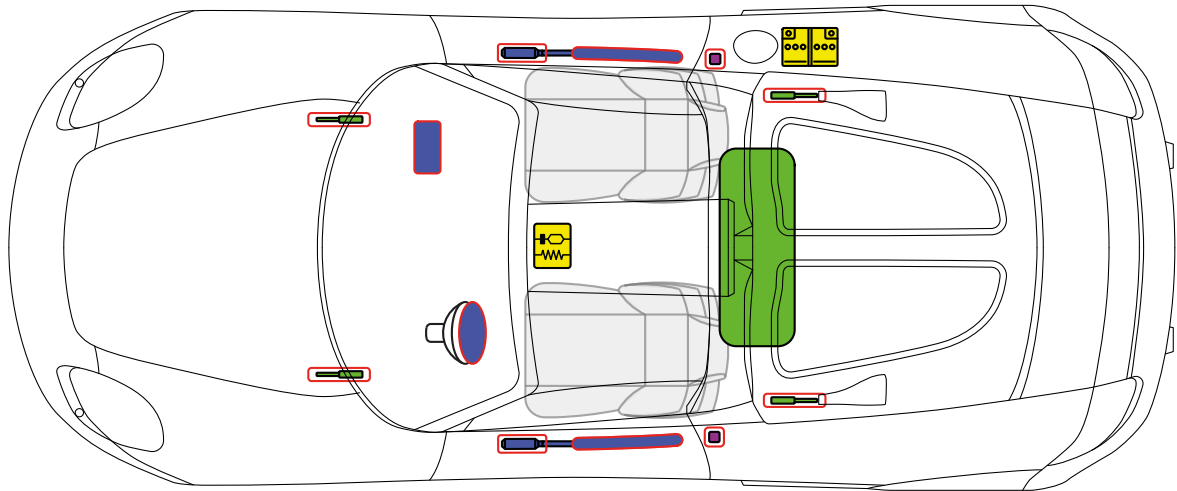

Batería

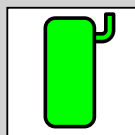

Depósito de combustible

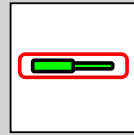

Amortiguador a gas

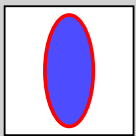

Airbag

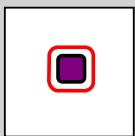

Pretensor del cinturón de seguridad

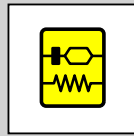

SRS-Unidad de control

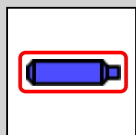

Generador de gas