



Porsche Mobile Charger

Good to know – Driver's Manual

06/2023

Porsche, the Porsche Crest, Panamera, Cayenne and Taycan are registered trademarks of Dr. Ing. h.c. F. Porsche AG.

Printed in Germany.

Reprinting – even of excerpts – or duplication of any kind are only permissible with the written authorisation of Dr. Ing. h.c. F. Porsche AG.

© Dr. Ing. h.c. F. Porsche AG

Porscheplatz 1
70435 Stuttgart
Germany

Driver's Manual

Always keep this operating manual and hand it over to the new owner if you sell your charger.

Due to different requirements in various countries, the information in the thumb index tabs of this manual will be different. To ensure that you are reading

the thumb index tab that applies to your country, compare the article number of the charger shown in the "Technical Data" section with the article number on the identification plate on the charger.

Suggestions

Do you have any questions, suggestions or ideas regarding your vehicle or this manual?

Please write to us:

Dr. Ing. h.c. F. Porsche AG
Vertrieb Customer Relations
Porscheplatz 1
70435 Stuttgart
Germany

Equipment

Because our vehicles undergo continuous development, equipment and specifications may not be as illustrated or described by Porsche in this manual. Items of equipment are not always according to the standard scope of delivery or country-specific vehicle equipment

For more information on retrofit equipment, please contact a qualified specialist workshop. Porsche recommends a Porsche partner as they have trained workshop personnel and the necessary parts and tools.

Because of different legal requirements in individual countries, the equipment in your vehicle may vary from what is described in this manual. If your Porsche is fitted with any equipment not described in this manual, your qualified specialist workshop will be glad to provide information on the correct operation and care of the items concerned.

About this Owner's Manual

Warning notices and symbols

Various types of Warning notices and symbols are used in this Driver's Manual.



Serious injury or death

Failure to observe Warning notices in the "Danger" category will result in serious injury or death.



Possible serious injury or death

Failure to observe Warning notices in the "Warning" category can result in serious injury or death.



Possible moderate or minor injury

Failure to observe Warning notices in the "Caution" category can result in moderate or minor injuries.

NOTICE

Possible vehicle damage

Failure to observe Warning notices in the "Notice" category can result in damage to the vehicle.



Information

Additional information is indicated by "Information".

- ✓ Conditions that must be met in order to use a function.
- ▶ Instruction that you must follow.

1. If an instruction comprises several steps, these are numbered.

2. Instructions that you must follow on the central display.

▶ Notice on where you can find further important information on a topic.

Further Information

You can access the full Driver's Manual at the following web address:

<https://tinyurl.com/porsche-e-help>



Table of contents

To the Driver's Manual

Key to pictograms..... 3

Security

Safety instructions..... 4

Intended use..... 5

Scope of delivery..... 5

Overview

Charger control unit..... 5

Requirements and conditions

Selecting the installation location..... 6

Required tools..... 6

Installing

Installing the wall mount..... 6

Set up

Vehicle charging cables and supply cables..... 8

Operating

Operating instructions..... 12

Charge..... 13

Control panel status indicators and error messages..... 15

Transport..... 20

Cleaning and maintenance..... 20

Disposal..... 20

Technical Data

Identification plate..... 24

Production information..... 24

Importers..... 24

Index..... 26

To the Driver's Manual

Key to pictograms

Depending on the country, various pictograms may be attached to the charger.

 Operate the charger within a temperature range from -30 °C to +50 °C.

 The charger should not be operated at altitudes of more than 4,000 m above sea level.

 The charger is equipped with a non-switched protective conductor.

 The charger is equipped with a switched protective conductor.



 Dispose of the charger in compliance with all applicable disposal regulations.



 Do not use extension cables or cable reels.



 Do not use (travel) adapters.

 Do not use multiple sockets.

 Do not use chargers with damaged electronics or connecting cables.

  Risk of electric shock due to unintended use.

  Observe the operating instructions provided, particularly the warnings and safety instructions.

  The surface of the charger can become very hot.

 Do not operate the charger in non-earthed mains supply systems (e. g. IT networks). Operate the charger only in earthed mains supply systems.

 Indicates the type 1 plug with a voltage range ≤ 250 VAC.

 Indicates the type 2 plug with a voltage range ≤ 480 VAC.

Security

Safety instructions

⚠ DANGER

Electric shock, short circuit, fire, explosion

- Use of a damaged or faulty charging cable or electrical socket, improper use of the charger or failure to observe the safety instructions can cause short circuits, electric shocks, explosions, fire or burns.
- ▶ Do not use a damaged and/or soiled charger. Check the cable and plug connection for damage and soiling before use.
 - ▶ Only connect the charger to properly installed and undamaged electrical sockets and fault-free electrical installations.
 - ▶ Do not use extension cables, cable reels, multiple sockets or (travel) adapters.
 - ▶ Disconnect the charger from the mains supply during thunderstorms.
 - ▶ Do not modify or repair any of the electrical components.
 - ▶ **Never** immerse the charger or plugs in water or spray them directly with water (e.g. high-pressure cleaning equipment or garden hoses).
 - ▶ Only clean the charger when the control unit has been fully disconnected from the mains supply and from the vehicle. Use a dry cloth for cleaning.

⚠ DANGER

Electric shock, fire

Incorrectly installed electrical sockets can cause electric shock or fire when the high-voltage battery is charged using the vehicle charge port.

- ▶ Installation and initial operation of the electrical socket for the charger may only be carried out by a qualified, electrically skilled person. The qualified electrician is fully responsible for compliance with the relevant standards and regulations.
 - ▶ The cross-section of the power cable for the electrical socket must be defined in accordance with the wire length and the locally applicable regulations and standards.
 - ▶ The electrical socket used for charging must be connected to a separately fused electric circuit that complies with local laws and standards.
 - ▶ The charger is intended for use in private and semi-public areas, e.g. private properties or company car parks. In some countries, e.g. in Italy and New Zealand¹, mode 2 charging is **prohibited** in public areas.
- Further information is available from your Porsche partner and from your local power supplier.
- ▶ Unauthorised persons (e.g. playing children) must not have access to the charger and the vehicle during unsupervised charging.
 - ▶ Please read the safety instructions in the installation manual and the Driver's Manual.

⚠ DANGER

Electric shock, fire

Incorrect handling of the plug contacts can lead to electric shock or fire.

- ▶ Do not touch the contacts on the vehicle charge port and charger.
- ▶ Do not insert any objects into the vehicle charge port or charger.
- ▶ Protect electrical sockets and plug connections against moisture, water and other liquids.

⚠ WARNING

Flammable or explosive vapours

Components of the charger can cause sparks and ignite flammable or explosive vapours.

- ▶ To reduce the risk of explosion – particularly in garages – make sure that the control unit is located at least 50 cm above the floor during charging.
- ▶ Do not install the charger in potentially explosive atmospheres.

Observe the following instructions and recommendations in order to guarantee uninterrupted charging with the charger:

- Before installation, check that the necessary power for charging a vehicle can be continuously provided with the currently available domestic installation. If necessary, protect the domestic installation with an energy management system.
- The charger should preferably be operated in earthed mains supply systems. The protective conductor lead must be properly installed.

1. Time of printing. Further information is available from your Porsche partner.

- When installing a new electrical socket, select an industrial electrical outlet with the highest possible power available (adapted to the domestic electric installation) and have it put into operation by a qualified electrician.
- Where technically possible and legally permissible, the electric installation must be dimensioned in such a way that the maximum nominal power of the electrical socket used is available for charging the vehicle.
- In order to make full use of the charger and to ensure fast vehicle charging, use either NEMA electrical sockets with the highest possible current rating appropriate for the power plug or industrial electrical outlets to IEC 60309.

- When charging the high-voltage battery via the household/industrial electrical outlet, the electrical installation may be loaded to its maximum capacity.

Porsche recommends that you have electrical installations used for charging checked regularly by a qualified electrician. Ask a qualified electrician which inspection intervals are appropriate for your installation.

- To prevent overheating of the electrical installation, the charging current for household cables is automatically limited on delivery. Have a qualified electrician bring the charger into operation and set the charging current limit as required for the domestic installation.

▷ Refer to chapter "Charging current limiting" on page 13.

Intended use

Charger with integrated control and protection for mode 2 charging, for charging vehicles with high-voltage batteries that meet the generally applicable standards and directives for electric vehicles.

- ▶ Always use the appropriate device version for the local mains supply.
 - ▷ Refer to chapter "Technical Data" on page 22.

The charger may only be used as a combination of supply cable, control panel and vehicle cable.

Scope of delivery

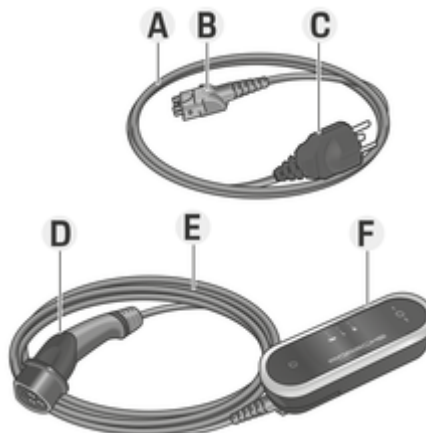

Fig. 1: Overview of Charger:

- A** Supply cables (detachable from control panel)
- B** Supply cable connection plug on the control panel
- C** Power plug for connecting to the mains supply
- D** Vehicle plug (connector plug for the vehicle)
- E** Vehicle cable (permanently installed on control panel)

F Control panel

Overview Charger control unit

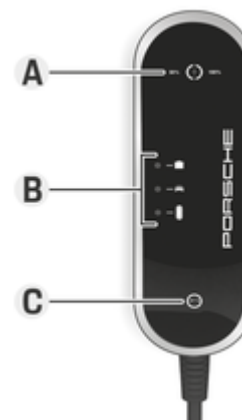

Fig. 2: Control unit

- A** ⏻ ON/OFF button with indicator light and additional charging current limiting function
- B** 🏠 Power supply/domestic connection indicator light
 - 🚗 Vehicle indicator light
 - 🔌 Control unit indicator light
- C** ⏻ Reset button with indicator light

The operating state of the control unit and charging current limiting can be set using the ON/OFF button (⏻).

The control unit can be reset using the reset button (⏻) if residual current is detected.

Requirements and conditions

The indicator lights **A – C** (Fig. 2) indicate the operating state of the control unit, whether charging current limiting is set and possible faults by means of different colours, illumination and flashing.

► Refer to chapter "Control panel status indicators and error messages" on page 15.

Requirements and conditions Selecting the installation location

DANGER

Electric shock, fire

Improper use of the charger or non-compliance with the safety instructions may result in short circuits, electric shocks, explosions, fire or burns.

- Do not install the basic wall mount in potentially explosive atmospheres.
- To reduce the risk of explosion - particularly in garages - make sure that the control unit is located at least 50 cm above the floor during charging.
- Observe the locally applicable electrical installation regulations, fire protection measures, accident prevention regulations and escape routes.

The basic wall mount is designed for indoor and outdoor installation.

The following criteria must be considered when selecting a suitable installation location:

- Install the electrical socket and basic wall mount preferably in a covered area protected against direct sunlight and rain (e.g. in a garage).
- Do not spray the basic wall mount directly with water (e.g. high-pressure cleaning equipment or garden hoses)

- Do not install the basic wall mount under suspended or hanging objects.
 - Do not install the basic wall mount in stables, livestock buildings or locations where ammonia gases occur.
 - Install the basic wall mount on a smooth surface.
 - In order to ensure secure fastening, check the condition of the wall before installing.
 - Install the basic wall mount so that it is not near pathways and the charging cables do not cross any pathways.
 - Install the basic wall mount so that the distance between the plug and the socket does not exceed the length of the available supply cable.
 - Install the electrical socket as close as possible to the preferred vehicle parking position. Take the orientation of the vehicle into account.
 - The distance of the electrical socket from the floor and ceiling should be selected in compliance with national regulations and standards so that comfortable use is ensured.
- Refer to chapter "Safety instructions" on page 4.

Required tools

- Level
- Power drill or power hammer
- Screwdriver

Installing Installing the wall mount Installing the basic wall mount

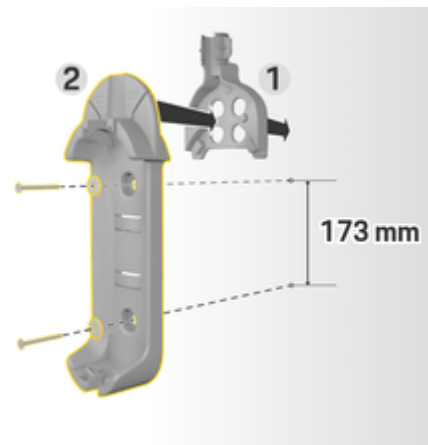

Fig. 3: Drilling dimensions

1. Mark the drill holes on the wall.
2. Drill the mounting holes and insert dowels.
3. Press the standard wall mount **2** (Fig. 3) into the cable guide **1** (Fig. 3) from the front.
4. Screw the basic wall mount onto the wall.

i Information

Attach the wall mount at a height of at least 1 m.

Installing the connector fastener

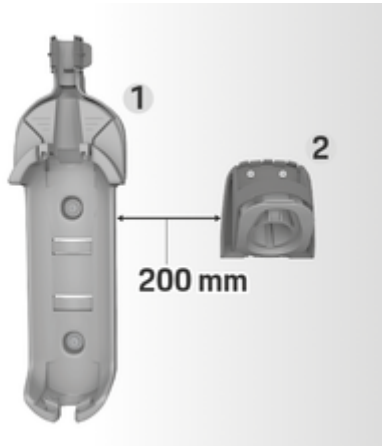

Fig. 4: Distance between wall mount and connector fastener
When installing the connector fastener, ensure a distance of 200 mm from the basic wall mount.

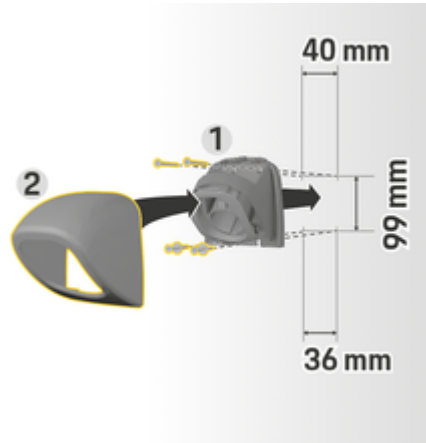

Fig. 5: Drilling dimensions

1. Remove the connector fastener **1** (Fig. 5) from the cover **2** (Fig. 5).
2. Mark the drill holes on the wall.
3. Drill the mounting holes and insert wall plugs.
4. Screw the connector fastener **1** (Fig. 5) onto the wall.
5. Fit the cover **2** (Fig. 5) onto the connector fastener **1** (Fig. 5) from below and push up.

Attaching the control unit to the wall mount



Fig. 6: Attaching the control unit

1. Route the vehicle cable through the lower opening of the basic wall mount, place the bottom of the control unit on the locking tab and push back to engage.
2. Guide the supply cable through the upper opening in the basic wall mount and lock the circlip by pushing it to the left.
3. Insert the vehicle plug in the connector fastener.

Set up

Vehicle charging cables and supply cables

Information on vehicle charging cables and plugs

Different vehicle charge ports **A** and vehicle plugs **B** are available depending on the vehicle equipment.



IEC 62196-2/
SAE-J1772-2009
Type 1



IEC 62196-2
Type 2



GB/T 20234.2
Type GB

Selecting a Supply cable

For regular charging with optimum charging speed, use only the supply cables listed below. The maximum achievable charging power is up to 11 kW (depending on the power supply/domestic connection and the on-board charger).

▷ Refer to chapter "Technical Data" on page 22.

NOTICE

Use only supply cables approved for the country you are in. The following supply cables are approved for specific countries and are defined in the tables below.

Country	Supply cables for industrial electrical outlets	Supply cables for household electrical outlets
Russia, Ukraine	5, 6, 7, 8	C
Abu Dhabi, Israel, Singapore	5, 6, 7, 8	Charging not permitted at household electrical outlets
Argentina	5, 6, 7, 8	C
Bolivia, Paraguay, Uruguay, St. Marteen, St. Martin	5, 6, 7, 8	B
Chile	5, 6, 7, 8	D
Peru	5, 6, 7, 8	A

Country-specific approval of supply cables (examples)

Supply cables for industrial electrical outlets



1
NEMA 14-30



2
NEMA 14-50



3
NEMA 6-30



4
NEMA 6-50



5
IEC 60309-2
CEE 230 V/16 A 6 h



6
IEC 60309-2
CEE 230 V/32 A 6 h



7
IEC 60309-2
CEE 400 V/16 A 6 h



8
IEC 60309-2
CEE 400 V/32 A 6 h



9
WCZ8 20 A

Supply cables for household electrical outlets

If no industrial electrical outlet is available, the supply cables listed below can also be used for charging with reduced charging speed.

- ▶ In some countries, e.g. in Abu Dhabi, Israel and Singapore¹, to charge from household electrical outlets is **prohibited**. Further information is available from your Porsche partner.



A
NEMA 5-15
Type B²



B
WCZ8 15 A



C
CEE 7/5; CEE 7/7
Type E/type F
(Safety plug)



D
BS 1363
Type G

1. Time of printing. Further information is available from your Porsche partner.

2. for Mexico: 12 A



E
M09A-15
Type I



F
SEV 1011
Type J

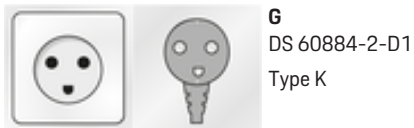

G
DS 60884-2-D1
Type K



H
CEI 23-16-VII
Type L 16 A
(5 mm)



I
IA6A3 (BS 546)
Type M

NEMA 6-50 / NEMA 14-50 (additional information)

Information

Scope

This usage recommendation applies only to regions with NEMA 6-50 / NEMA 14-50 standard.

Charging your vehicle may result in high electric currents. For safety reasons, it is absolutely essential that you use only components approved for this and that the entire charging equipment is installed correctly.

General safety instructions

DANGER Electric shock and fire!

Incorrect use of the charging equipment and failure to observe the installation and safety instructions can lead to a short circuit, electric shock, explosion, fire or burns.

- ▶ Pay attention to the installation instructions in the charging equipment manual.
- ▶ Pay particular attention to all safety and warning notices there.
- ▶ Have the installation carried out by a person with the necessary electrical training and specialist knowledge.
- ▶ Also observe the national regulations for carrying out electrical installations.

Power socket requirements

DANGER Unsuitable mains sockets

An unsuitable mains socket can cause a short circuit, electric shock, explosion, fire, or burns.

- ▶ Only use only a type of mains socket that is suitable for this installation (see **Suitable types of mains sockets/power plugs**).
- ▶ Only use mains sockets that meet the requirements for the quality of contact surfaces and fastening (see **Requirements for the quality of mains sockets**).
- ▶ Avoid direct contact between the terminal screws and the wire. Preferably, use wire end ferrules.
- ▶ Avoid jamming the cable on the insulation.

Suitable mains socket/power plug types



NEMA 6-50
Socket/connector



NEMA 14-50
Socket/connector

Mains sockets quality requirements

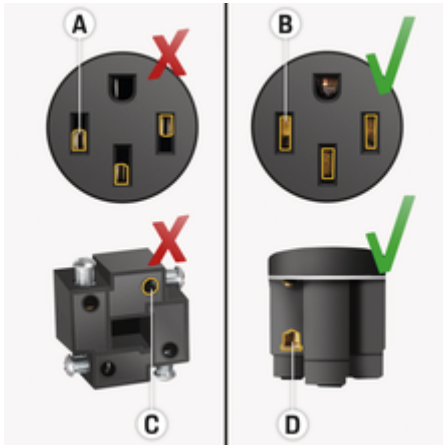

- A** Contact surface only half plug contact height
- B** Contact surface over the entire plug-in contact height
- C** Small contact surface between clamping screw and strand.
- D** Broad surface contact area between between clamping plate and strand

Line installation requirements

⚠ DANGER

Unsuitable power cable

The use of unsuitable power cables or excessive electrical currents can cause a short circuit, electric shock, explosion, fire or burns.

- ▶ The cable must have a 50-amp fuse.
- ▶ Only use copper cables with a minimum cross-section of 8 AWG, or preferably 6 AWG.

1. Time of printing. Further information is available from your Porsche partner.

Outdoor installation requirements

⚠ DANGER

Direct contact with rain

If the charging equipment is used outdoors, direct contact with rain can cause a short circuit, electric shock, explosion, fire or burns.

- ▶ Prevent the charging equipment from coming into direct contact with rain.
- ▶ Use a NEMA 3R rainproof enclosure.

Changing supply cables

⚠ DANGER

Electric shock

Risk of serious or fatal injury from electric shock.

- ▶ Before changing the supply cable, always unplug the supply cable from the electrical socket and disconnect the vehicle cable from the vehicle charge port.
- ▶ Only change cables in a dry environment.
- ▶ Only use the control unit with vehicle cable in conjunction with a supply cable included in the scope of supply or a supply cable approved by Porsche.
 - ▷ Refer to chapter "Scope of delivery" on page 5.
- ▶ In some countries, e.g. in Norway or Japan¹, changing the supply cable is **prohibited**. Further information is available from your Porsche partner.



Fig. 7: Plug of the supply cable connection on the control unit.

The plug of the supply cable connection can be removed and inserted at the top of the control unit.

Disconnecting the supply cable

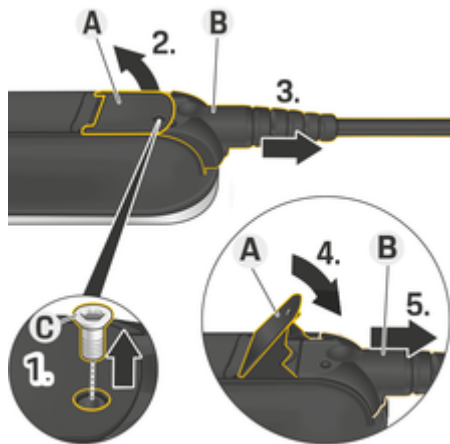

Fig. 8: Disconnecting cables

- ✓ Charging of the high-voltage battery has ended and the vehicle plug has been removed from the vehicle charge port.
 - ✓ The plug has been disconnected from the electrical socket.
1. Remove screw **C** (Fig. 8) using a suitable tool.
 2. Lift lever **A** (Fig. 8).
 3. Pull out plug **B** (Fig. 8) until you first feel resistance.
 4. Close lever **A**.
 5. Pull out plug **B** fully.

Securing supply cables and plugs

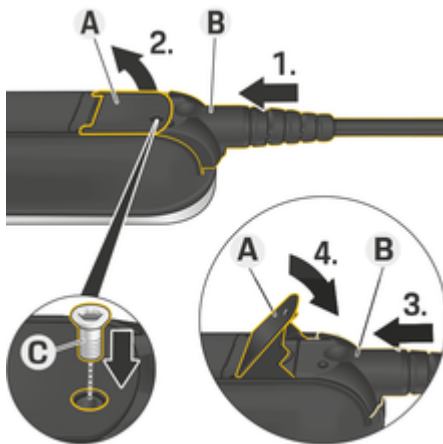

Fig. 9: Connecting cables and securing plugs

- ✓ Lever **A** (Fig. 9) is closed.
1. Insert plug **B** (Fig. 9) into the control unit until you first feel resistance.
 2. Lift lever **A**.
 3. Push in plug **B** fully.
 4. Close lever **A**.
 5. Secure plug **B** to the control unit with screw **C** (Fig. 9).

Operating Operating instructions

NOTICE

Risk of damage to the charger

- ▶ Always place the charger on a solid surface when charging.
- ▶ Porsche recommends operating the charger in the basic wall mount. In certain countries, e.g. in Switzerland¹, the charger may only be operated in the basic wall mount.
 - ▷ Refer to chapter "Installing the wall mount" on page 6.
- ▶ Do **not** immerse the charger in water.
- ▶ Protect the charger from snow and ice.
- ▶ Protect the charger from potential damage due to being driven over, dropped, pulled, bent or crushed.

The charger must only be operated within a temperature range from $-30\text{ }^{\circ}\text{C}$ to $+50\text{ }^{\circ}\text{C}$.

i Information

- To prevent overheating during operation, avoid exposing the charger to continuous direct sunlight. If the control panel overheats, the charging process is interrupted automatically until the temperature has sunk to the normal range.
- When driving abroad, always carry the appropriate supply cable with you for use in the country you are visiting.
- Different safety concepts with different device types are prescribed, depending on the country. Before driving abroad, ensure that the charger may also be operated in the respective country. Contact your Porsche partner or local power supplier.

1. Time of printing. Further information is available from your Porsche partner.

Charge

Charging instructions

Vehicle charge port

For information on connecting and disconnecting the vehicle cable to and from the vehicle charge port and for the charging and connection status at the vehicle charge port:

► Refer to the Driver's Manual.

Charging times

For information on charging times:

► Refer to the Driver's Manual.

The charging duration can vary depending on the following factors:

- Current-carrying capacity of the electrical outlet used
(domestic electrical outlet or industrial electrical outlet)
- Country-specific mains voltage and electric current
- Settings for charging current limiting on the control unit
- Fluctuations in the mains voltage
- Ambient temperature of vehicle and charger.
Charging times may be longer in the limit ranges of the permissible ambient temperature.
► Refer to chapter "Technical Data" on page 22.
- Temperature of the high-voltage battery and control unit
- Passenger compartment precooling/heating activated

Information

Due to different national mains supply systems, various cable versions are supplied. This may result in the full charging power not being available. Further information is available from your Porsche partner.

Charging

 **DANGER**

Electric shock, fire

Risk of serious or fatal injury due to fire or electric shock.

- Always observe the specified order for the charging procedure.
- Do not unplug the vehicle cable from the vehicle charge port during charging.
- End the charging process before disconnecting the vehicle cable from the vehicle charge port.
- Do not disconnect the charger from the electrical socket during charging.

Possible faults are indicated by means of different colours, illumination and flashing of indicator lights **A** – **C** (Fig. 2).

► Refer to chapter "Control panel status indicators and error messages" on page 15.

Starting charging

1. Insert the plug into the electrical socket. The indicator lights briefly light up red.
2. Insert the vehicle plug in the vehicle charge port.
 - The indicator light on the ON/OFF button  lights up yellow.

Following a successful self-test, all the indicator lights light up green for 2 seconds.

For information on connecting the vehicle cable to the vehicle charge port:

► Refer to the Driver's Manual.

3. Charging starts automatically.
 - The indicator light on the ON/OFF button  pulses green.

Charging is controlled by the vehicle.

The charge status is displayed in the vehicle.

Charging current limiting

The control panel detects the voltage and the available current automatically. Using charging current limiting, full or half charging power (100% or 50%) can be set. The last charging current set is saved. To prevent overheating of the electrical installation with household cables, the charging current is limited at delivery to 50% when using household electrical sockets ► P. 9.

Setting limitation of charging current

- Press On/Off button  for at least 2 seconds.
 - After the limitation of charging current has been set successfully, the indicator lights **B** (Fig. 2) flash green once.

The set power (50% or 100%) is indicated to the left or right of the On/Off button .

Deactivating and activating protective conductor monitoring

DANGER

Electric shock, short circuit, fire, explosion

Using the charger without active protective conductor monitoring may result in electric shocks, short circuits, fires, explosions or burns.

- ▶ The charger should preferably be operated in earthed mains supply systems.
- ▶ Only **deactivate** protective conducting monitoring in **non-earthed** mains supply systems (e.g. IT networks).
- ▶ **Activate** protective conducting monitoring in **earthed** mains supply systems.

▶ Refer to chapter "Activating protective conductor monitoring" on page 14.

Deactivating protective conductor monitoring

- ✓ Protective conductor monitoring has interrupted the charging process.
- ✓ A message relating to an interrupted or absent protective conductor is indicated at the control unit:

 ON/OFF lights up red.

 Power supply/domestic connection lights up red.



 Vehicle lights up red.

 Control unit is off.

 Reset is off.

1. Press the ON/OFF  and Reset  buttons.

After the control unit indicator light  flashes 6 times, release the buttons.

2. After 1 second, press the ON/OFF  and Reset  buttons again.

After the control unit indicator light  flashes 6 times, release the buttons.

- ➔ Protective conductor monitoring is deactivated automatically after a short time.
The status display for deactivated protective conductor monitoring is displayed on the control unit:

 ON/OFF pulses green.

 Power supply/domestic connection lights up yellow.

 Vehicle lights up yellow.



 Control unit is off.

 Reset is off.

Activating protective conductor monitoring

- ▶ Press the ON/OFF  and Reset  buttons.





















After the control unit indicator light  flashes 6 times, release the buttons.

- ➔ The yellow power supply/domestic connection  and Vehicle  indicator lights go out.





















Activation of the protective conductor monitoring is performed automatically after a short time.

























The ON/OFF indicator light  pulses green.

Control panel status indicators and error messages





















Pilot lights	Meaning	Remedy
<ul style="list-style-type: none">  ON/OFF lights up green.  Power supply/household connection is off.  Vehicle is off.  Control panel is off.  Reset is off. 	The charger is ready but not charging.	<ul style="list-style-type: none"> ▶ Start charging process. ▶ Refer to chapter "Starting charging" on page 13.
<ul style="list-style-type: none">  ON/OFF pulses green.  Power supply/household connection is off.  Vehicle is off.  Control panel is off.  Reset is off. 	The vehicle is charging with protective conductor monitoring activated.	
<ul style="list-style-type: none">  ON/OFF pulses green.  Mains supply/household connection lights up yellow.  Vehicle is off.  Control panel is off.  Reset is off. 	<p>The power plug is overheated.</p> <p>Possible cause: multiphase electrical socket connected only as single phase.</p> <p>Charging process is at reduced power.</p>	<p>The fault is automatically reset once the power plug has cooled.</p> <p>Until it has cooled, charging is only at reduced power.</p> <ul style="list-style-type: none"> ▶ If the fault persists, have the power supply/household connection checked by a qualified electrician.
<ul style="list-style-type: none">  ON/OFF pulses green.  Mains supply/household connection lights up yellow.  Vehicle lights up yellow.  Control panel is off.  Reset is off. 	The vehicle is being charged with protective conductor monitoring deactivated.	<p>The vehicle should ideally be charged with protective conductor monitoring activated.</p> <ul style="list-style-type: none"> ▶ Refer to chapter "Activating protective conductor monitoring" on page 14.





















Control panel status indicators and error messages

Pilot lights	Meaning	Remedy
<ul style="list-style-type: none">  ON/OFF pulses green.  Power supply/household connection is off.  Vehicle is off.  Control panel lights up yellow.  Reset is off. 	<p>The control panel is overheated.</p> <p>Charging process is at reduced power.</p>	<p>The fault is automatically reset once the control panel has cooled.</p> <p>Until it has cooled, charging is only at reduced power.</p> <ul style="list-style-type: none"> ▶ If the fault persists, have the control panel checked by a specialist dealer/ Porsche Partner.
<ul style="list-style-type: none">  ON/OFF lights up red.  Mains supply/household connection lights up yellow.  Vehicle is off.  Control panel is off.  Reset is off. 	<p>The power plug is overheated.</p> <p>The charging process is interrupted.</p>	<p>The fault is automatically reset and charging resumed once the power plug has cooled.</p> <ul style="list-style-type: none"> ▶ If the fault persists, have the power supply/household connection checked by a qualified electrician.
<ul style="list-style-type: none">  ON/OFF lights up red.  Power supply/household connection is off.  Vehicle is off.  Control panel lights up yellow.  Reset is off. 	<p>The control panel is overheated.</p> <p>The charging process is interrupted.</p>	<p>The fault is automatically reset and charging resumed once the control panel has cooled.</p> <ul style="list-style-type: none"> ▶ If the fault persists, have the control panel checked by a specialist dealer/ Porsche Partner.
<ul style="list-style-type: none">  ON/OFF lights up red.  Power supply/household connection flashes yellow.  Vehicle is off.  Control panel is off.  Reset is off. 	<p>The power supply/household connection charging infrastructure is limited.</p> <p>Possible cause: Undervoltage or poor mains frequency.</p> <p>The charging process is interrupted.</p>	<p>After the mains supply/household connection has stabilised, the fault is automatically reset and charging resumed.</p> <ul style="list-style-type: none"> ▶ If the fault persists, have the power supply/household connection checked by a qualified electrician.

Pilot lights	Meaning	Remedy
<ul style="list-style-type: none">  ON/OFF lights up red.  Power supply/household connection is off.   Vehicle flashes yellow.  Control panel is off.  Reset is off. 	<p>The vehicle charging system has malfunctioned.</p> <p>The charging process is interrupted.</p>	<p>After the vehicle charging system has stabilised, the fault is automatically reset and charging resumed.</p> <ul style="list-style-type: none"> ▶ If the fault persists, have the vehicle checked by a specialist dealer/Porsche Partner.
<ul style="list-style-type: none">  ON/OFF lights up red.  Power supply/household connection is off.   Vehicle is off.   Control panel flashes yellow.  Reset is off. 	<p>The supply or vehicle cable is faulty.</p> <p>Possible cause: The coding resistances of the supply and vehicle cables do not match.</p> <p>The charging process is interrupted.</p>	<ul style="list-style-type: none"> ▶ Have the supply or vehicle cable replaced by a specialist dealer/Porsche Partner.
<ul style="list-style-type: none">  ON/OFF lights up red.  Power supply/household connection is off.   Vehicle lights up red.  Control panel is off.  Reset is off. 	<p>The vehicle charging system has malfunctioned.</p> <p>The charging process is interrupted.</p>	<ul style="list-style-type: none"> ▶ End the charging process from the vehicle and disconnect the vehicle cable from the vehicle charge port. ▶ Disconnect charger from mains supply and reconnect after 60 seconds. ▶ Restart charging process. <ul style="list-style-type: none"> ▷ Refer to chapter "Starting charging" on page 13. ▶ If the fault persists, have the vehicle checked by a specialist dealer/Porsche Partner.
<ul style="list-style-type: none">  ON/OFF lights up red.  Power supply/household connection flashes red.   Vehicle is off.  Control panel is off.  Reset is off. 	<p>There is overvoltage in the power supply/household connection charging infrastructure.</p> <p>The charging process is interrupted.</p>	<ul style="list-style-type: none"> ▶ Disconnect charger from mains supply and reconnect after 60 seconds. ▶ If the fault persists, have the power supply/household connection checked by a qualified electrician.

Control panel status indicators and error messages

Pilot lights	Meaning	Remedy
<ul style="list-style-type: none">  ON/OFF lights up red.  Power supply/household connection is off.  Vehicle is off.  Control panel lights up red.  Reset is off. 	<p>The control panel has a technical fault.</p> <p>The charging process is interrupted.</p>	<ul style="list-style-type: none"> ▶ Disconnect charger from mains supply and reconnect after 60 seconds. ▶ If the fault persists, have the control panel checked by a specialist dealer/ Porsche Partner.
<ul style="list-style-type: none">  ON/OFF lights up red.  Power supply/household connection is off.  Vehicle is off.  Control panel flashes red.  Reset is off. 	<p>The control panel has a technical fault (self-test failed).</p> <p>The charging process is interrupted.</p>	<ul style="list-style-type: none"> ▶ Disconnect charger from mains supply and reconnect after 60 seconds. ▶ If the fault persists, have the control panel checked by a specialist dealer/ Porsche Partner.
<ul style="list-style-type: none">  ON/OFF lights up red.  Power supply/household connection lights up red.  Vehicle lights up red.  Control panel is off.  Reset is off. 	<p>The power supply/household connection charging infrastructure is insufficient: The protective conductor is interrupted or not present.</p> <p>Protective conductor monitoring has interrupted the charging process.</p>	<ul style="list-style-type: none"> ▶ Only non-earthed mains supply systems (e.g. IT networks): If necessary, charge the vehicle with protective conductor monitoring deactivated. <ul style="list-style-type: none"> ▶ Refer to chapter "Deactivating protective conductor monitoring" on page 14. ▶ Only earthed mains supply systems: Have the control panel checked by a specialist dealer/ Porsche Partner and the power supply/household connection checked by a qualified electrician.
<ul style="list-style-type: none">  ON/OFF lights up red.  Power supply/household connection lights up red.  Vehicle lights up red.  Control panel lights up red.  Reset is off. 	<p>The indicator light in the Reset button on the control unit is defective.</p> <p>The charging process is interrupted.</p>	<ul style="list-style-type: none"> ▶ Have the control panel replaced by a specialist dealer/ Porsche Partner.

Pilot lights	Meaning	Remedy
<ul style="list-style-type: none">  ON/OFF lights up red.  Power supply/household connection lights up red.  Vehicle lights up red.  Control panel lights up red.  Reset flashes red. 	<p>The control unit has detected residual current.</p> <p>The charging process is interrupted.</p>	<ul style="list-style-type: none"> ▶ Press  button for at least 2 seconds. ▶ If the fault persists, have the control unit checked by a specialist dealer/ Porsche Partner and the power supply/household connection checked by a qualified electrician.
<ul style="list-style-type: none">  ON/OFF lights up red.  Power supply/household connection flashes red.  Vehicle flashes red.  Control panel flashes red.  Reset is off. 	<p>The charging infrastructure is incorrectly wired.</p> <p>The charging process is interrupted.</p>	<ul style="list-style-type: none"> ▶ Disconnect the charger from the mains supply. ▶ Have the mains supply/household connection checked by a qualified electrician.
<ul style="list-style-type: none">  ON/OFF lights up red.  Power supply/household connection lights up red.  Vehicle lights up red.  Control panel lights up red.  Reset lights up red. 	<p>The control panel has a technical fault.</p> <p>Possible cause: Software error or load relay incorrectly switched.</p> <p>The charging process is interrupted.</p>	<ul style="list-style-type: none"> ▶ Disconnect charger from mains supply and reconnect after 60 seconds. ▶ If the fault persists, have the control unit checked by a specialist dealer/ Porsche Partner and the power supply/household connection checked by a qualified electrician.
<ul style="list-style-type: none">  ON/OFF flashes red.  Power supply/household connection is off.  Vehicle is off.  Control panel lights up red.  Reset is off. 	<p>The control panel has a serious fault.</p> <p>The charging process is interrupted.</p>	<ul style="list-style-type: none"> ▶ Have the control panel replaced by a specialist dealer/ Porsche Partner.

Pilot lights	Meaning	Remedy
<ul style="list-style-type: none"> ⏻ ON/OFF is off. 🔴🏠 Power supply/household connection lights up red. 🔴🚗 Vehicle lights up red. 🔴🚗 Control panel lights up red. 🔄 Reset lights up red. 	<p>The indicator light in the ON/OFF button on the control panel is defective.</p> <p>The charging process is interrupted.</p>	<ul style="list-style-type: none"> ▶ Have the control panel replaced by a specialist dealer/ Porsche Partner.

Transport

⚠️ WARNING

Unsecured load

An unsecured, incorrectly secured or incorrectly positioned charger can slip out of place and endanger the vehicle occupants during braking, acceleration, direction changes or in accidents.

- ▶ Never transport the charger unsecured.
- ▶ Stow the charger in the transport case in the luggage compartment.
- ▶ Always transport the charger in the luggage compartment, never in the passenger compartment (e.g. on or in front of the seats).

For information on the tie-down rings in the luggage compartment:

- ▶ Refer to the Driver's Manual.

Securing transport case

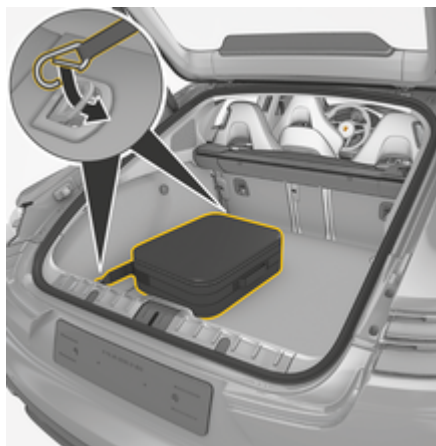

Fig. 10: Securing Transport Case (e.g. Panamera 4 E-Hybrid)

- ▶ Attach the transport case to the front and rear tie-down rings with hooks.

Cleaning and maintenance

Check the charger regularly for damage and soiling and clean if necessary.

⚠️ DANGER

Electric shock, fire

Risk of serious or fatal injury due to fire or electric shock.

- ▶ Never immerse the charger or plugs in water or spray them directly with water (e.g. high-pressure cleaning equipment or garden hoses).
- ▶ Only clean the charger when the control unit has been fully disconnected from the mains supply and from the vehicle. Use a dry cloth for cleaning.

Disposal

Electric/electronic devices and used batteries



Electrical/electronic devices and batteries can be deposited at a collection point or waste management facility.

Electric and electronic devices that are labelled with the crossed-out waste bin symbol as well as used batteries must not be thrown away with the domestic waste, but rather must be disposed of properly.

- ▶ Observe country-specific disposal regulations.
- ▶ Hand in old batteries and electric and electronic devices at a collection point.
- ▶ The 12-volt lithium battery is hazardous goods. Do not tamper with this battery and never dispose of it yourself.

For further information on proper disposal:

- ▶ Contact your Porsche partner.

Driver's Manual



Observe disposal instructions in accordance with the marking.

Technical Data

Electrical data 9Y0.971.675...	AK AM BC MCB36E1 x ¹ MCB36S1 x ¹ MCB36J1 x ¹	AP MCB72E2 x ¹	AN AR MCB72E1 x ¹ MCB72S1 x ¹	BD MCB96J1 x ¹	AS MCB11E3 x ¹
Power	3.6 kW	7.2 kW	7.2 kW	9.6 kW	11 kW
Rated current	16 A, 1-phase	16 A, 2-phase	32 A, 1-phase	40 A, 1-phase	16 A, 3-phase
Mains voltage	100 V – 240 V	100 V – 240V/400 V	100 V – 240 V	100 V – 240 V	100 V – 240V/400 V
Mains frequency	50 Hz/60 Hz	50 Hz/60 Hz	50 Hz/60 Hz	50 Hz/60 Hz	50 Hz/60 Hz
Overvoltage category (EN 60664)	II	II	II	II	II
Rated short-time withstand current (EN 61439-1)	< 10 kA eff.	< 10 kA eff.	< 10 kA eff.	< 10 kA eff.	< 10 kA eff.
Integrated residual current device	Type A (AC: 30 mA) + DC: 6 mA	Type A (AC: 30 mA) + DC: 6 mA	Type A (AC: 30 mA) + DC: 6 mA	Type A (AC: 30 mA) + DC: 6 mA	Type A (AC: 30 mA) + DC: 6 mA
Vehicle plug	Type 2: MCB36E1	Type 2	Type 2: MCB72E1	Type 1	Type 2
	Type 1: MCB36S1, MCB36J1		Type 1: MCB72S1		
Protection class	I	I	I	I	I

1. The "x" stands for pending design changes and can be any letter.

Electrical data 9Y0.971.675...	AK AM BC MCB36E1 x MCB36S1 x ¹ MCB36J1 x ¹	AP MCB72E2 x ¹	AN AR MCB72E1 x ¹ MCB72S1 x ¹	BD MCB96J1 x ¹	AS MCB11E3 x ¹
Degree of protection	IP55 (NEMA 3)	IP55 (NEMA 3)	IP55 (NEMA 3)	IP55 (NEMA 3)	IP55 (NEMA 3)
Mechanical data					
Weight of control panel	2.4 - 3.5 kg				
Wall mount dimensions	136 mm × 391 mm × 76 mm (Width × Height × Depth)				
Weight of wall mount	approx. 450 g				
Cable guide dimensions	127 mm × 139 mm × 115 mm (Width × Height × Depth)				
Weight of cable guide	approx. 420 g				
Connector fastener dimensions	136 mm × 173 mm × 50 mm (Width × Height × Depth)				
Weight of connector fastener	approx. 140 g				
Weight of complete basic wall mount	approx. 1 kg				
Ambient and storage conditions					
Ambient temperature	-30°C to +50°C				
Humidity	5% – 95% non-condensing				
Altitude	max. 4,000 m above sea level				

Identification plate

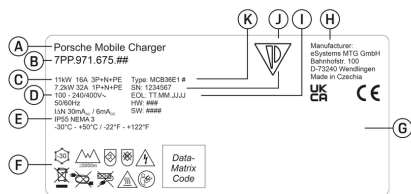

Fig. 11: Identification plate (example)

- A** Product name
- B** Product number
- C** Power and rated current
- D** Mains voltage
- E** Degree of protection
- F** Pictograms for operation
- G** Certification details
- H** Manufacturer
- I** Date of manufacture
- J** Serial number
- K** Type designation

Production information

Date of manufacture

The date of manufacture of the charger can be found on the identification plate after the abbreviation "EOL".

It is shown in the following format: Day of production.Month of production.Year of production

Charger manufacturer

Aptiv Services Deutschland GmbH
Am Technologiepark 1
42119 Wuppertal

Germany
Phone +49 202 291 0

Electrical testing

In the event of questions on regular electrical testing of the charging infrastructure (e.g. VDE 0702), please refer to <https://www.porsche.com/international/accessoriesandservice/porscheservice/vehicleinformation/documents/> or contact a Porsche partner.

Brazil



03725-21-12707

Este equipamento opera em caráter secundário, isto é, não tem direito a proteção contra interferência prejudicial, mesmo de estações do mesmo tipo, e não pode causar interferência a sistemas operando em caráter primário". Para maiores informações, consulte o site da ANATEL www.anatel.gov.br

Importers

Vereingte Arabische Emirate

Abu Dhabi: Ali & Sons Co. L.L.C
Porsche Centre Abu Dhabi

Zayed 2nd Street
Abu Dhabi
United Arab Emirates
P.O. Box 915
Telefon: +971 2 619 3911

Dubai: Al Nabooda Automobiles L.L.C

Porsche Centre Dubai
Sheikh Zayed Road E11
Dubai
United Arab Emirates
P.O. Box 10773
Telefon: +971 4 305 8555

Great Britain

Porsche Cars Great Britain Ltd.
Bath Road
Calcot, Reading, Berkshire
RG31 7SE
United Kingdom



Colombia

Autoelite S.A.S
Av. Carrera 70
No. 99-15, Bogotá

México

Volkswagen de México S.A. de C.V.
Autopista México Puebla km 116
San Lorenzo Almecatla, Cuautlancingo
72700 Puebla
Telefon: +52 222 230 9971

Russia

Porsche Russland
Ленинградское шоссе дом 71А, строение 10
125445, Москва, Россия
Telefon: +7-495-580-9911

Singapore

Porsche Asia Pacific Pte Ltd
20 McCallum Street #12-01
Tokio Marine Centre
Singapore 069046

Index

C

Charge status.....	13
Charging cable	
Cable and plug types.....	8
Plugging in/unplugging.....	13
Charging current limiting.....	13
Charging times.....	13
Cleaning.....	20
Connection status.....	13
Control panel	
Pictograms.....	3
Control unit	
Attaching to the wall mount.....	7
Overview.....	5

D

Date of manufacture.....	24
Disposal.....	20

E

Error messages.....	15
---------------------	----

G

General safety instructions.....	4
----------------------------------	---

H

Household electrical outlets.....	9
-----------------------------------	---

I

Identification plate.....	24
Importers.....	24
Industrial electrical outlets.....	9
Installing the basic wall mount.....	6
Installing the connector fastener.....	7
Intended use.....	5

L

Limiting of charging current.....	13
-----------------------------------	----

M

Maintenance.....	20
Manufacturer.....	24

O

Operating instructions.....	12
Outlets	
Household.....	9
Industrial.....	9
Overview of control unit.....	5

P

Pictograms.....	3
Pilot lights.....	15
Production information.....	24
Protective conductor monitoring	
Activating.....	14
Deactivating.....	14

R

Required tools.....	6
---------------------	---

S

Safety instructions.....	4
Scope of delivery.....	5
Selecting a Supply cable.....	8
Selecting the installation location.....	6
Serial number.....	24
Starting charging.....	13
Supply cable	
Changing.....	11
Selecting.....	8
Symbols in this Owner's Manual.....	1

T

Technical Data.....	22
Tools.....	6
Transport of the charger.....	20
Transporting charger.....	20

V

Vehicle charging cable	
Cable and plug types.....	8
Plugging in/unplugging.....	13

W

Warning notices setup.....	1
----------------------------	---