



PORSCHE

포르쉐 모델 개요

모델 명칭	모델 연도(MY)	모델 명칭	모델 연도(MY)
356 Urmotiv/356 A/356 B/356 C:		944:	
356 Coupé, 모든 파생 상품	1948 ~ 1965	944 Coupé, 모든 파생 상품	1982 ~ 1991
356 Cabriolet, Speedster American-Roadster, 모든 파생 상품	1948 ~ 1965	944 Cabriolet, 모든 파생 상품	1989 ~ 1991
356 Convertible-D (Hardtop)/ Hardtop-Cabriolet, 모든 파생 상품	1952 ~ 1965	959:	
550:		959 Coupé, 모든 파생 상품	1986 ~ 1988
550 Coupé, 모든 파생 상품	1952 ~ 1957	911 (964):	
550 Spyder, 모든 파생 상품	1953 ~ 1957	911 Coupé, 모든 파생 상품	1989 ~ 1994
911 Urmotiv:		911 Targa, 모든 파생 상품	1990 ~ 1994
911 Coupé, 모든 파생 상품	1965 ~ 1973	911 Cabriolet, Speedster, 모든 파생 상품	1990 ~ 1994
911 Targa, 모든 파생 상품	1965 ~ 1973	911 Turbo, 모든 파생 상품	1990 ~ 1994
911 G-Model:		968:	
911 Coupé, 모든 파생 상품	1974 ~ 1989	968 Coupé, 모든 파생 상품	1991 ~ 1995
911 Targa, 모든 파생 상품	1974 ~ 1989	968 Cabriolet, 모든 파생 상품	1991 ~ 1995
911 Cabriolet, 모든 파생 상품	1983 ~ 1989	911 (993):	
911 G-Model Turbo (930):		911 Coupé, 모든 파생 상품	1994 ~ 1998
911 Coupé, 모든 파생 상품	1975 ~ 1989	911 Targa, 모든 파생 상품	1994 ~ 1998
911 Targa, 모든 파생 상품	1986 ~ 1989	911 Cabriolet, 모든 파생 상품	1994 ~ 1998
911 Cabriolet, 모든 파생 상품	1986 ~ 1989	Boxster (986):	
912:		Boxster Cabriolet, 모든 파생 상품	1997 ~ 2004
912 Coupé, 모든 파생 상품	1965 ~ 1969	911 (996):	
912 Coupé E, 모든 파생 상품	1976	911 Coupé, 모든 파생 상품	1998 ~ 2005
912 Targa, 모든 파생 상품	1965 ~ 1969	911 Targa, 모든 파생 상품	1998 ~ 2005
914:		911 Cabriolet, 모든 파생 상품	1998 ~ 2005
914 Targa, 모든 파생 상품	1970 ~ 1976	980:	
924:		Carrera GT, Cabriolet, 모든 파생 상품	2003 ~ 2006
924 Coupé, 모든 파생 상품	1976 ~ 1988		
928:			
928 Coupé, 모든 파생 상품	1977 ~ 1995		

법적고지:

© Dr. Ing. h.c. F. Porsche AG

버전: 2019/02



PORSCHE

법적고지:

포르쉐 구조 데이터시트는 교통사고 인명 구조 기술 분야에서 전문적 교육을 받은 구급 요원들을 대상으로 작성되었으며, 이 목적을 위해서만 사용할 수 있습니다.

본 데이터시트에는 차체 구조, 수동 안전 시스템 및 대체 구동 시스템과 사용 가능한 다양한 장비 옵션에 대한 정보가 포함되어 있습니다.

포르쉐는 구급 작업을 수행하는 전문가가 아닙니다. 그러므로 모든 구급 요원은 비상 구급 작업 전에 이 정보를 평가하고 그들의 전문 지식을 기반으로 전략을 설계하고 결정을 내려야 합니다. 포르쉐에서는 훈련의 일환으로 포르쉐의 대표적인 차량들을 검사하여 이 정보를 완전하게 이해할 것을 모든 구급 요원에게 권장하는 바입니다.

해당 부분을 포함한 본 문서는 저작권법에 의해 보호됩니다. 상업적 사용이나 응용에는 포르쉐 AG의 사전 서면 동의가 있어야 합니다. 이는 특히 복제, 처리, 편집, 번역, 마이크로 필름화 및 데이터베이스와 온라인 서비스를 포함한 전자 시스템에 저장 및/또는 처리에 대해 적용됩니다.

포르쉐 AG는 언제라도 구조 데이터시트 내용을 수정하고 보완할 권리를 명시적으로 보유합니다. 본 정보는 인쇄 시점을 기준으로 최신 내용입니다. 포르쉐는 본 정보의 개정, 수정 또는 대체에 대한 모든 의무를 배제합니다.



Porsche AG, 356 Urmodell, 356 A, 356 B, 356 C

Coupé, 모든 파생 상품

PORSCHE 1948년형에서 1965년형까지

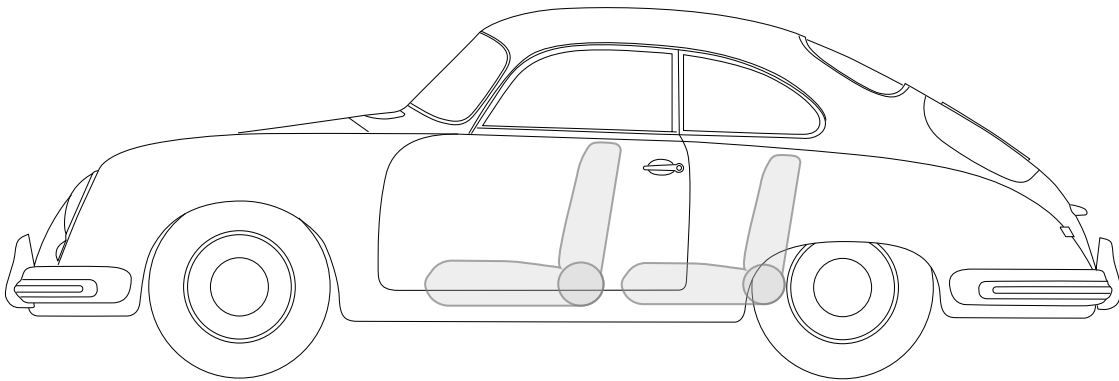
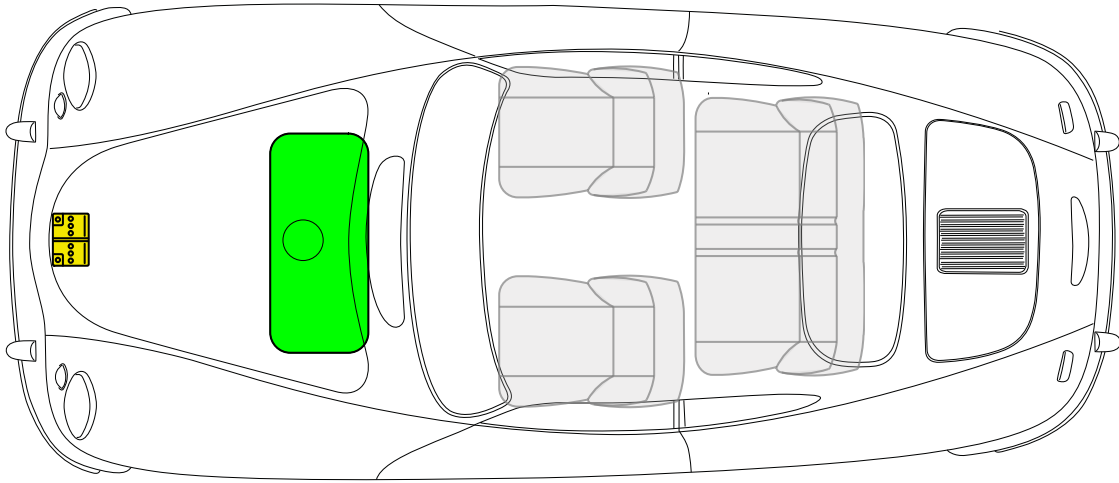

연료 탱크

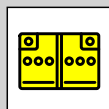

배터리



Porsche AG, 356 Urmotell, 356 A, 356 B, 356 C

Cabriolet, 모든 파생 상품

PORSCHE 1948년형에서 1965년형까지

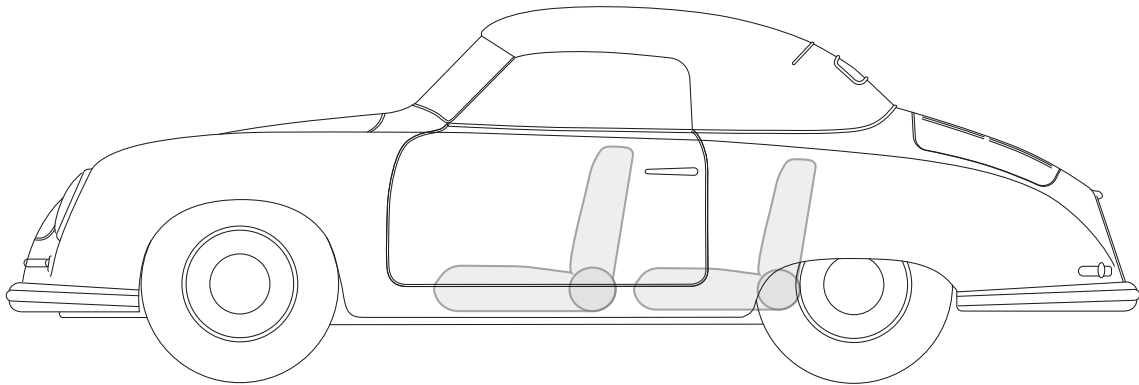
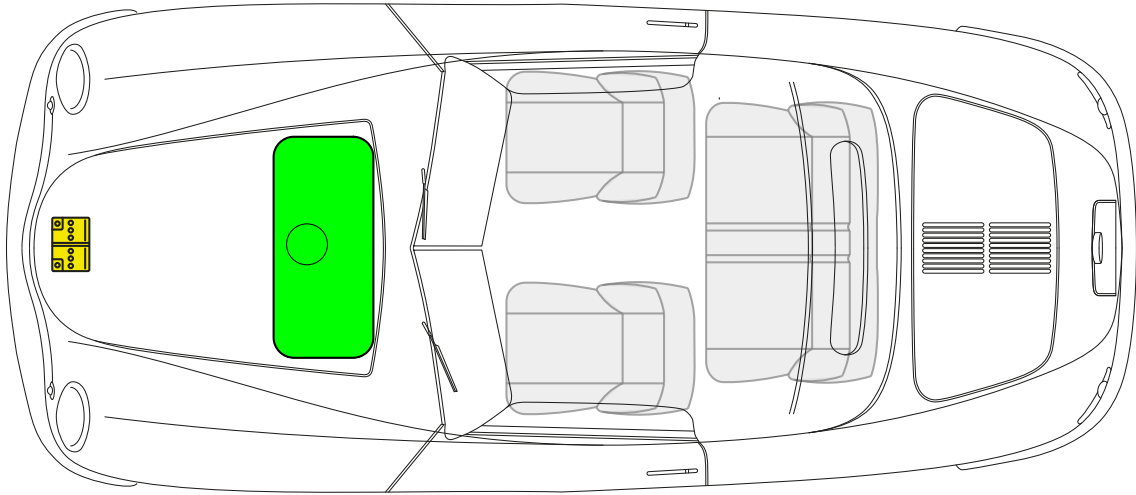

연료 탱크

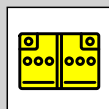

배터리



Porsche AG, 356 Urmotell, 356 A, 356 B, 356 C
Convertible-D (Hardtop), Hardtop-Cabriolet, 모든 파생 상품
1952년형에서 1965년형까지

PORSCHE

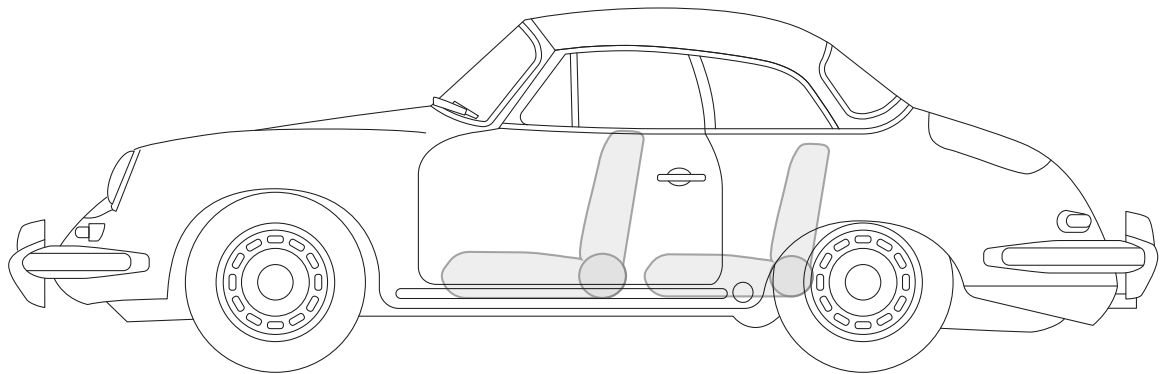
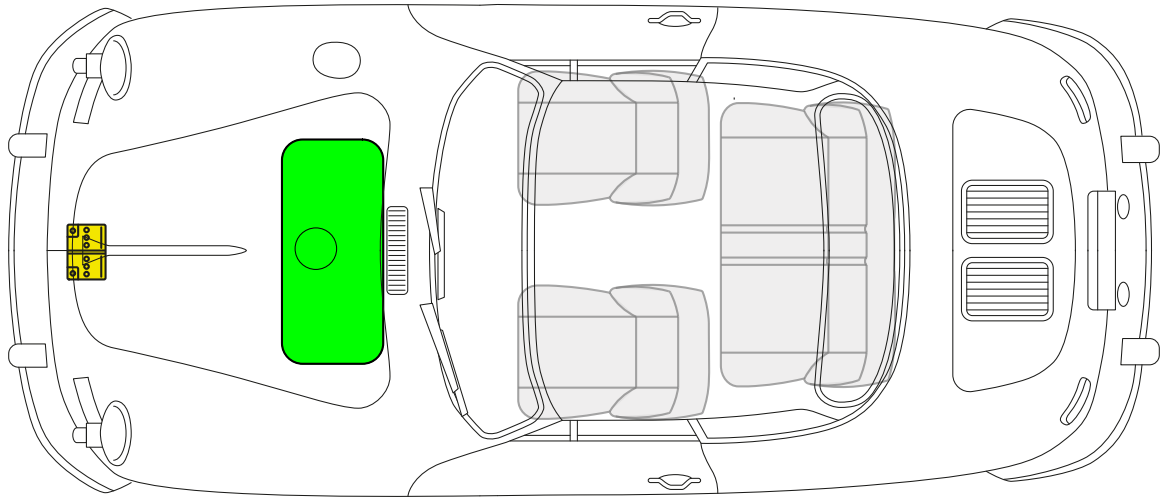

연료 탱크

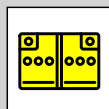

배터리



Porsche AG, 550, Coupé,
모든 파생 상품

PORSCHE 1952년형에서 1957년형까지

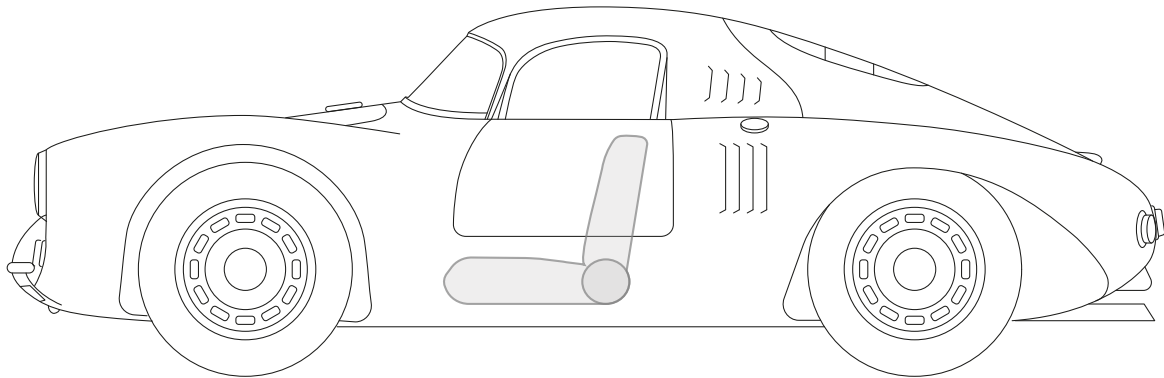
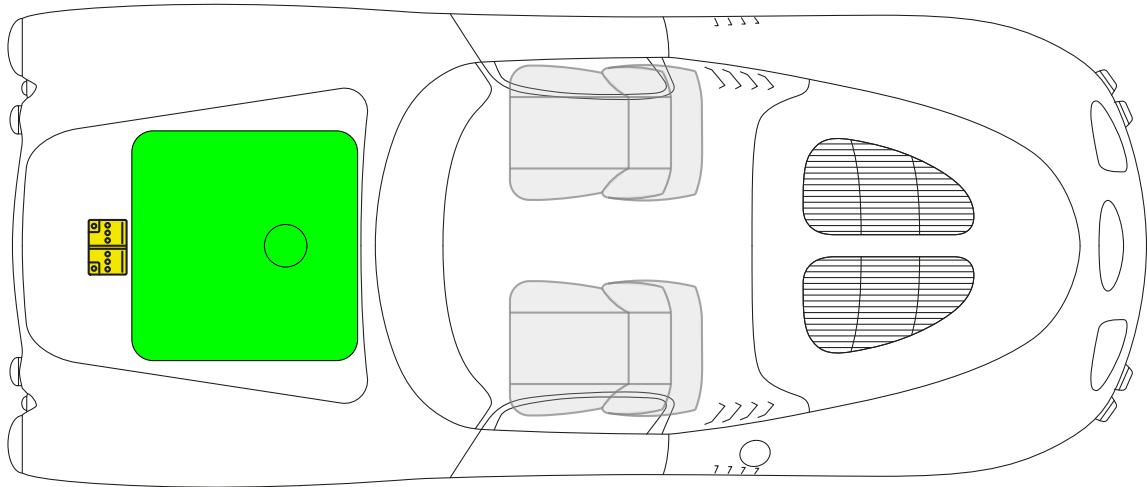

연료 탱크

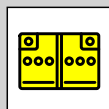

배터리



Porsche AG, 550, Spyder,
모든 파생 상품

PORSCHE 1953년형에서 1957년형까지

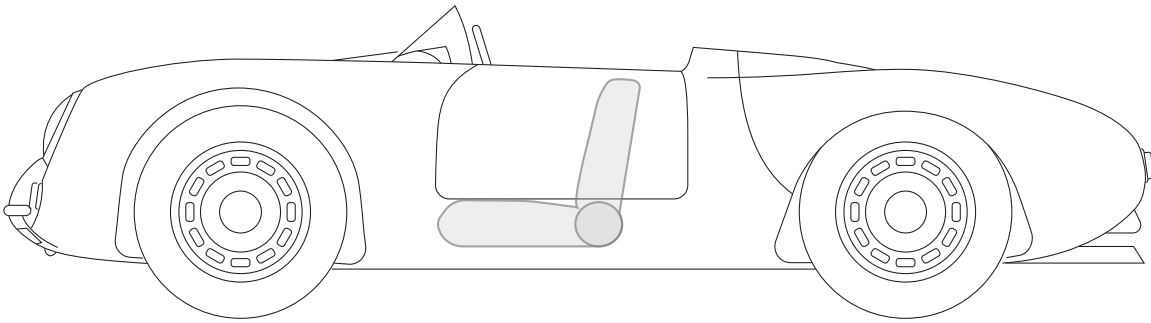
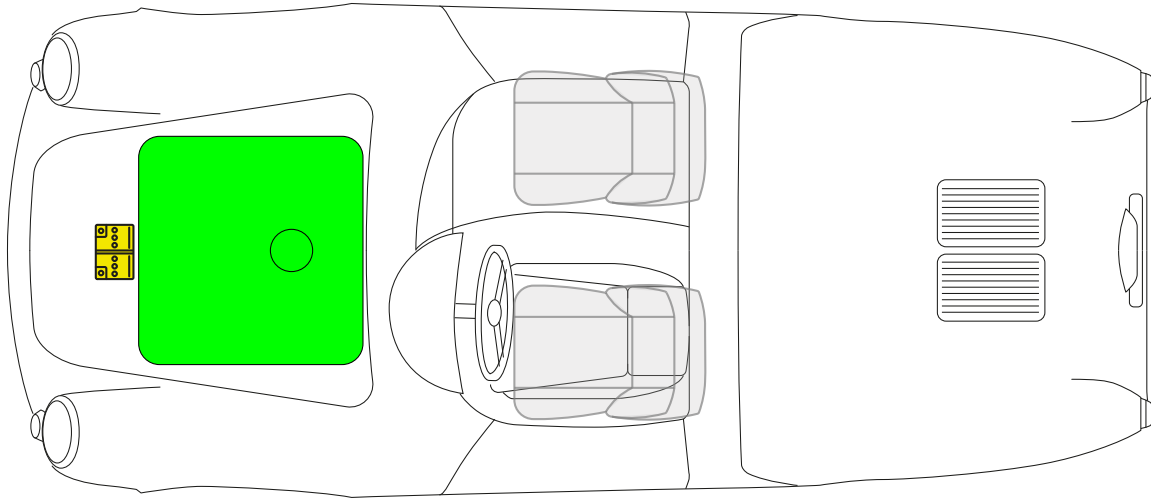

연료 탱크

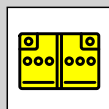

배터리



Porsche AG, 911 Urmodell, Coupé,

모든 파생 상품

PORSCHE 1965년형에서 1973년형까지

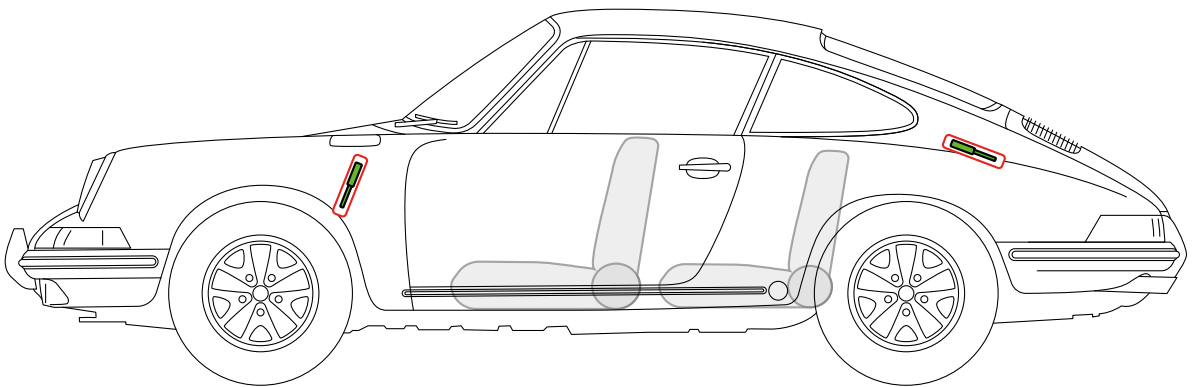
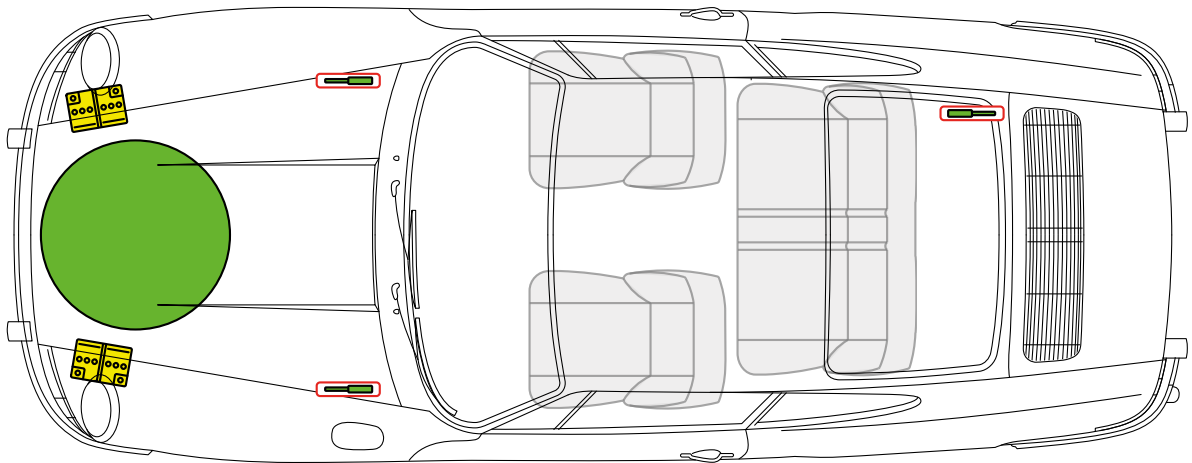
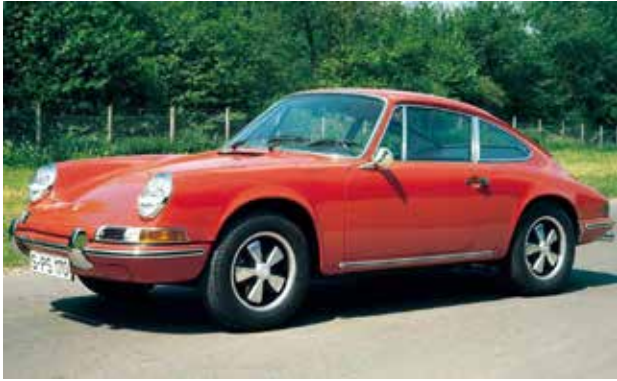

연료 탱크

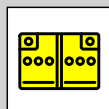

배터리

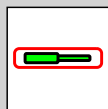

가스 압력 댐퍼



Porsche AG, 911 Urmodell, Targa, 모든 파생 상품

PORSCHE 1965년형에서 1973년형까지

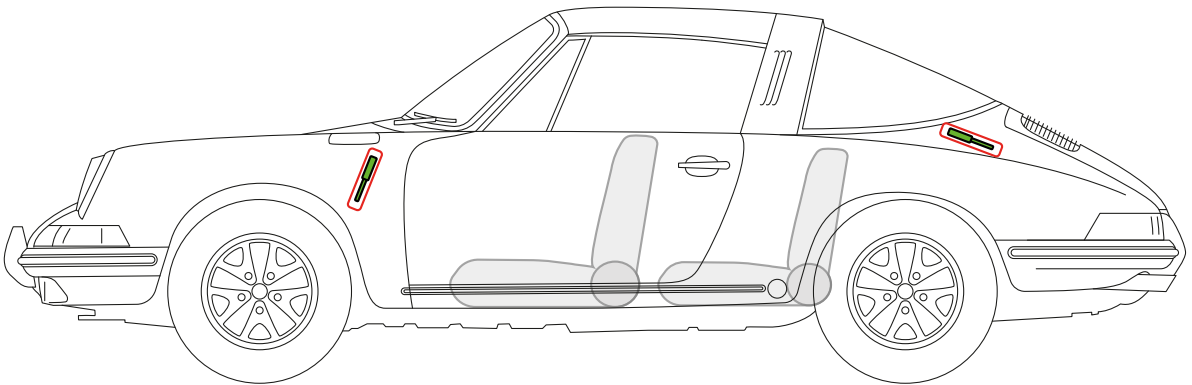
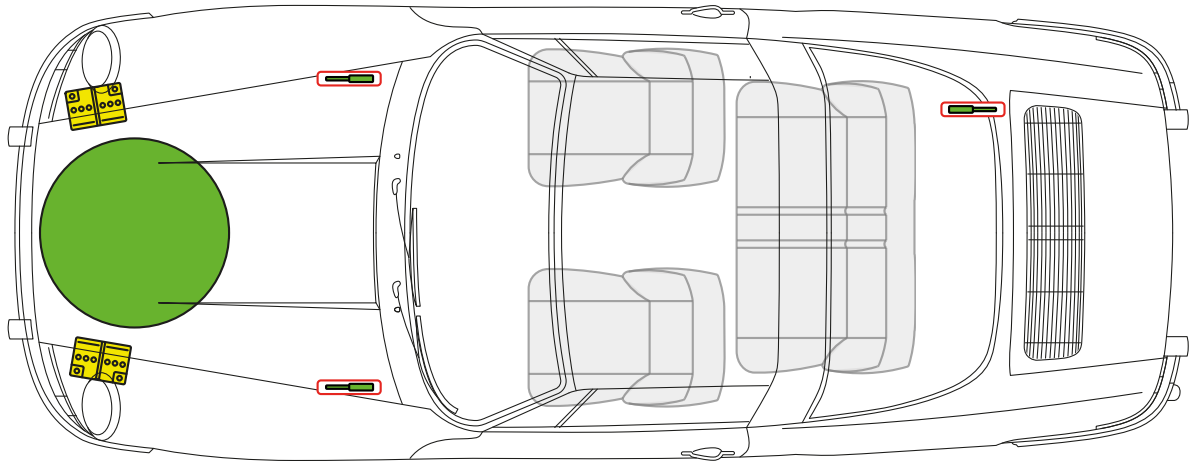

연료 탱크

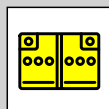

배터리

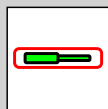

가스 압력 댐퍼



Porsche AG, 911 G-Model, Coupé, 모든 파생 상품

PORSCHE 1974년형에서 1989년형까지

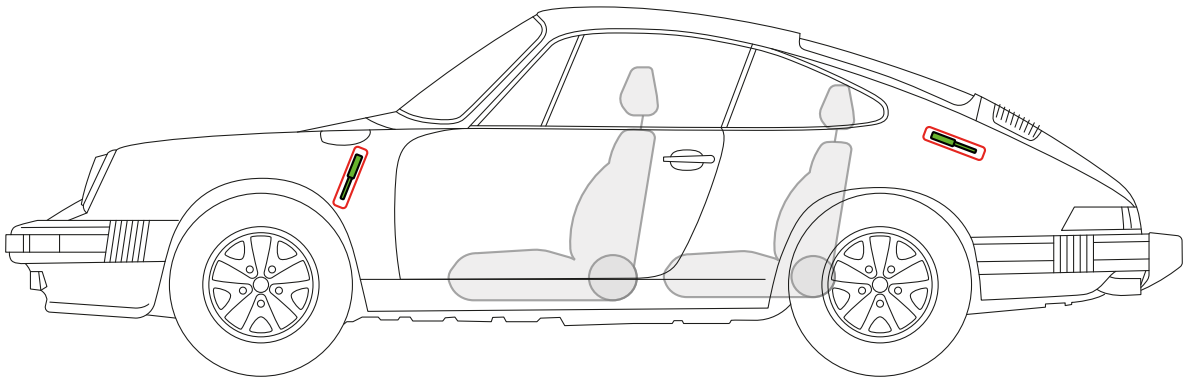
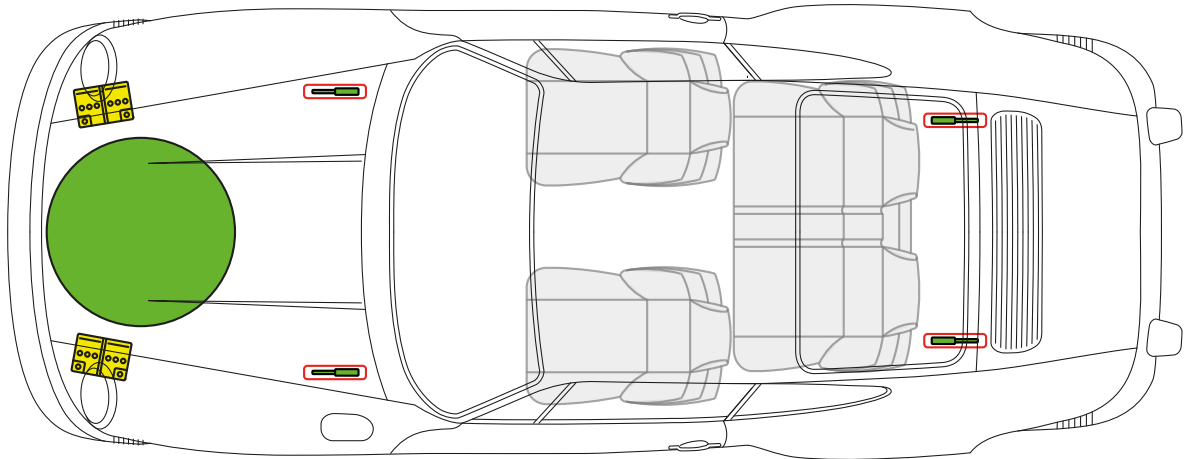
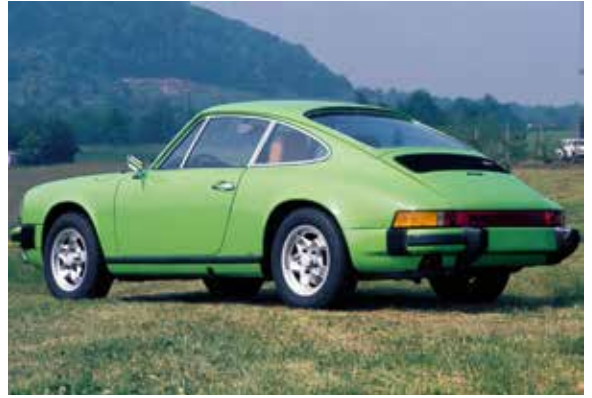

연료 탱크

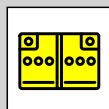

배터리

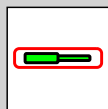

가스 압력 댐퍼



Porsche AG, 911 G-Model, Targa, 모든 파생 상품

PORSCHE 1974년형에서 1989년형까지

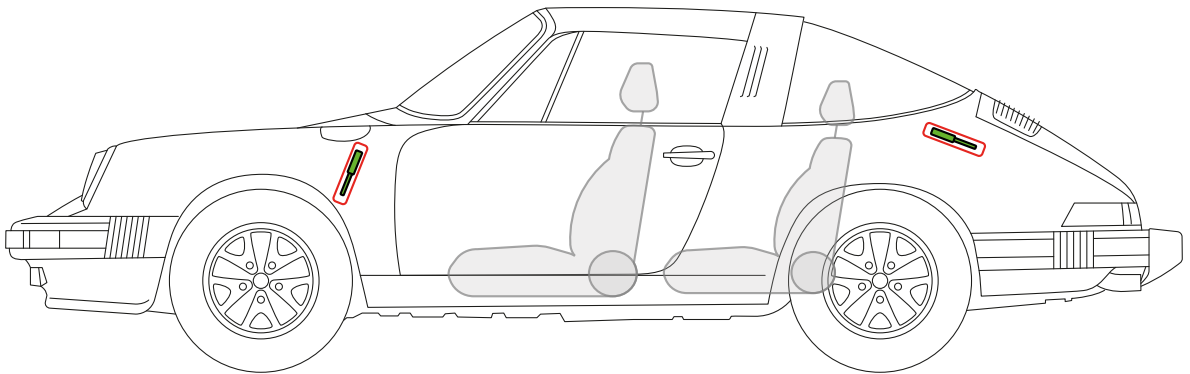
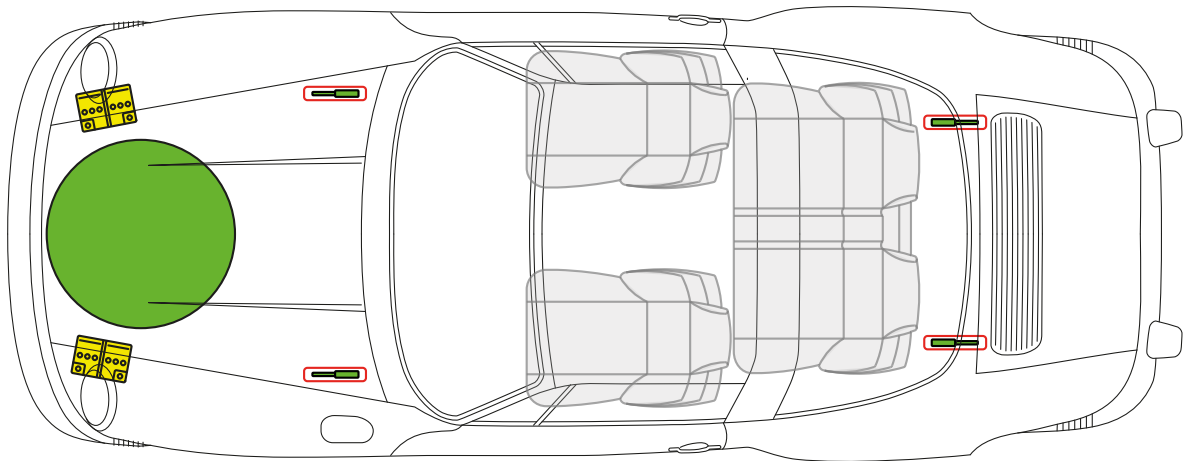

연료 탱크

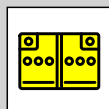

배터리

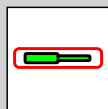

가스 압력 댐퍼



Porsche AG, 911 G-Model, Cabriolet, 모든 파생 상품

PORSCHE 1983년형에서 1989년형까지

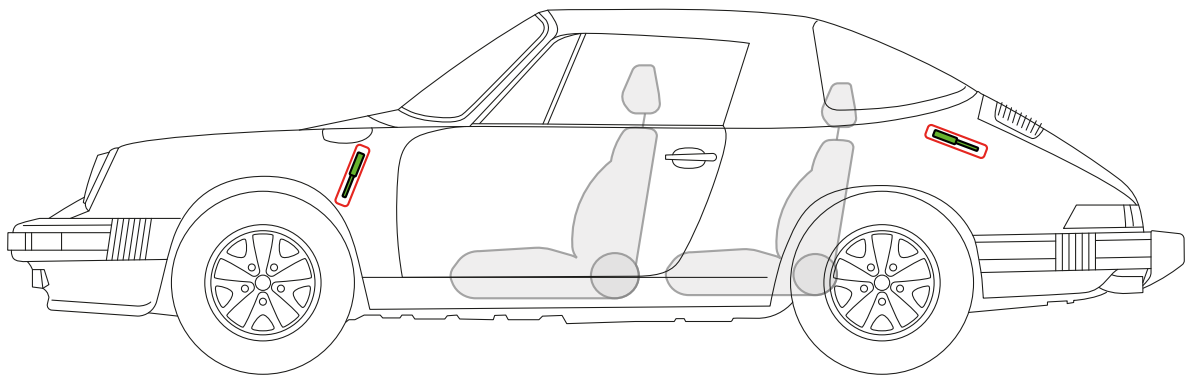
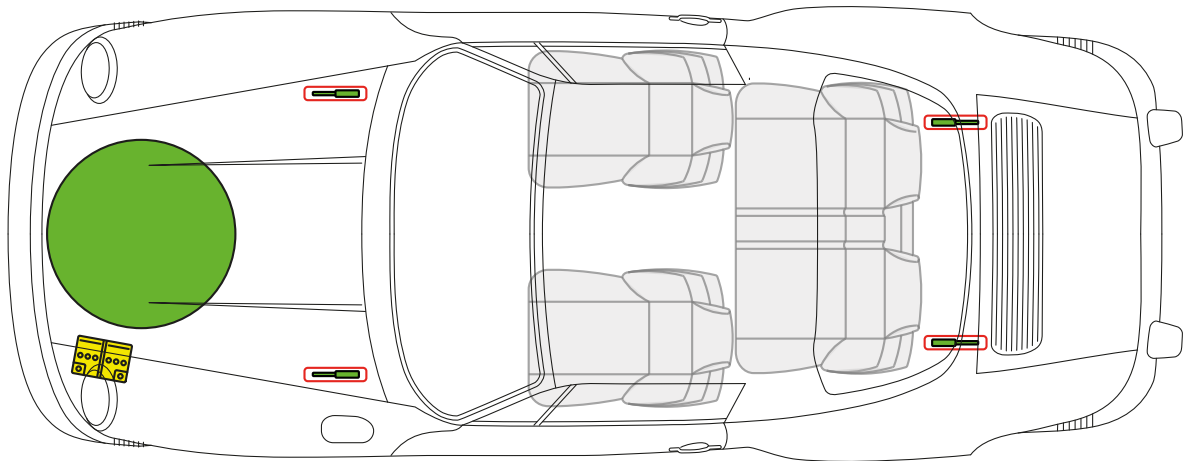

연료 탱크

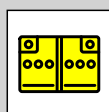

배터리

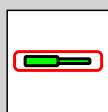

가스 압력 댐퍼



Porsche AG, 911 G-Model Turbo (930), Coupé,

모든 파생 상품

PORSCHE 1974년형에서 1989년형까지

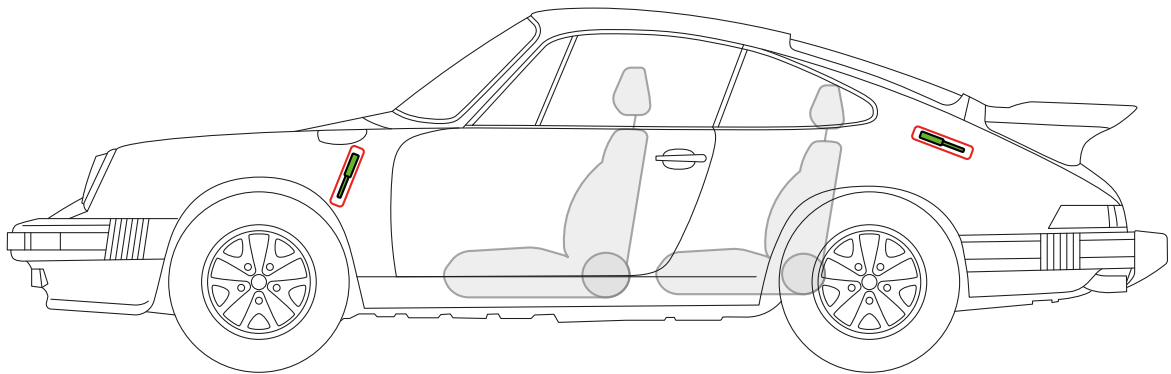
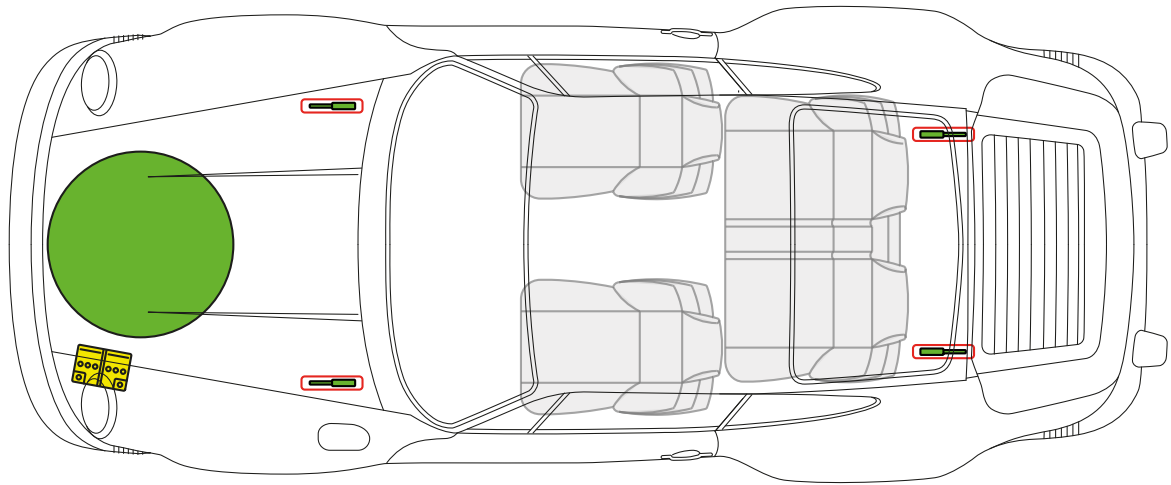

연료 탱크

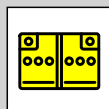

배터리

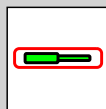

가스 압력 댐퍼



Porsche AG, 911 G-Model Turbo (930), Targa, 모든 파생 상품

PORSCHE 1986년형에서 1989년형까지

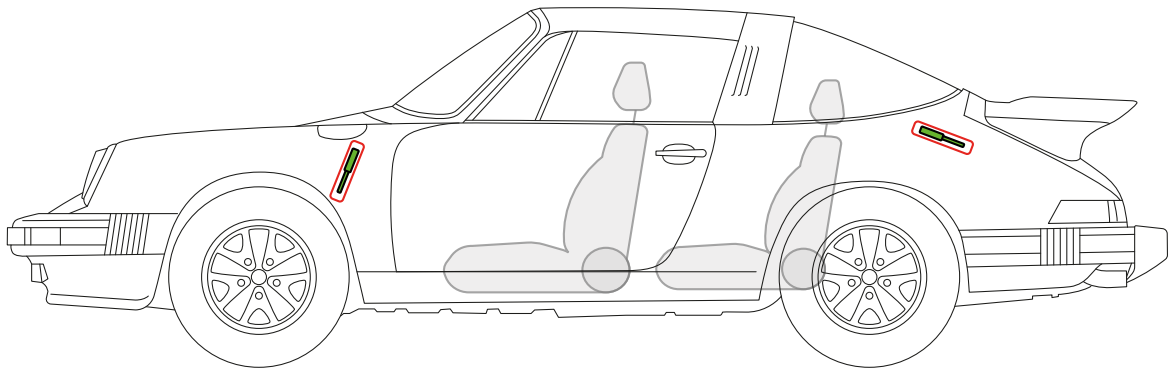
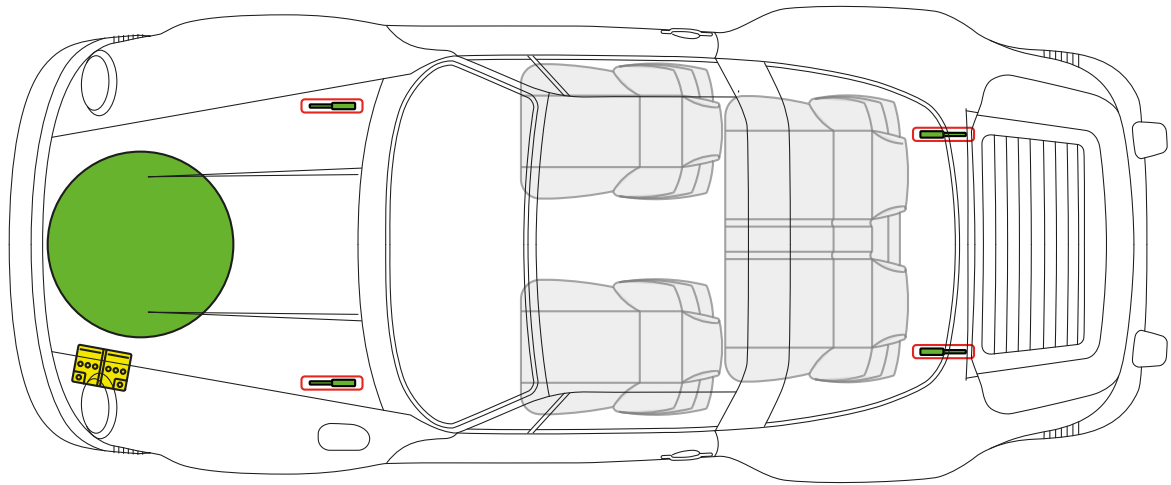

연료 탱크

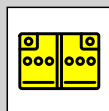

배터리

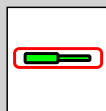

가스 압력 댐퍼



Porsche AG, 911 G-Model Turbo (930), Cabriolet, 모든 파생 상품

PORSCHE 1986년형에서 1989년형까지

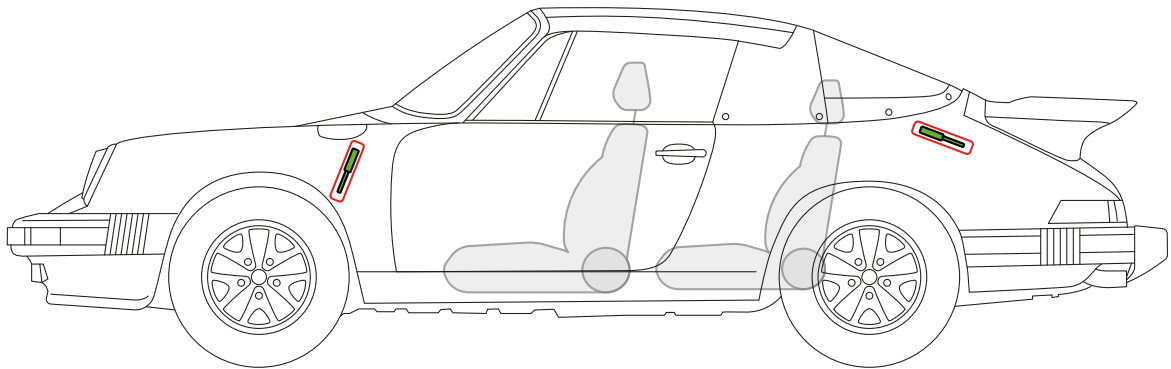
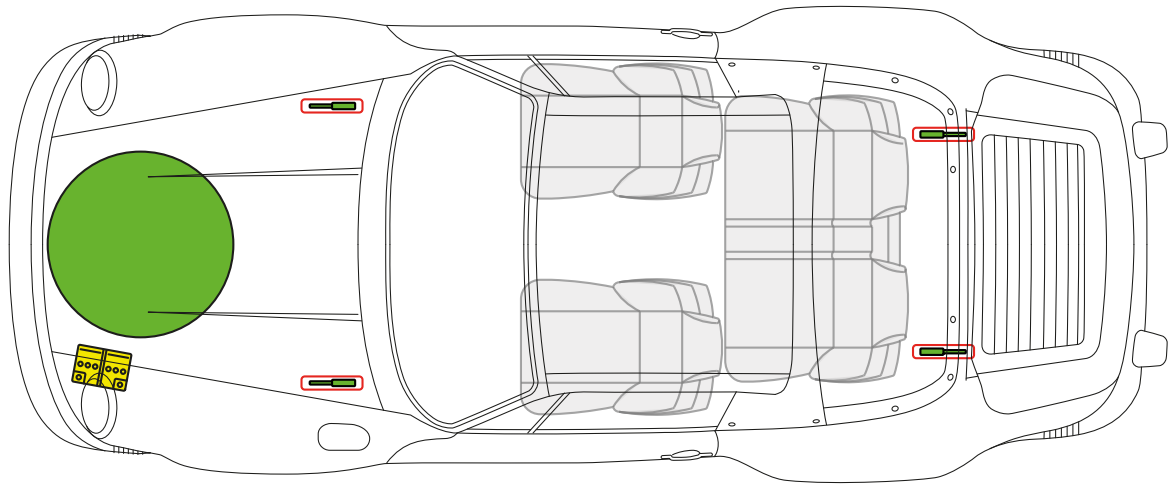

연료 탱크

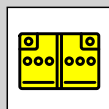

배터리

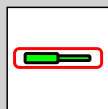

가스 압력 댐퍼



Porsche AG, 912, 912 E, Coupé,

모든 파생 상품

PORSCHE 1965년형에서 1969년형까지, 1976년형부터 (912 E)

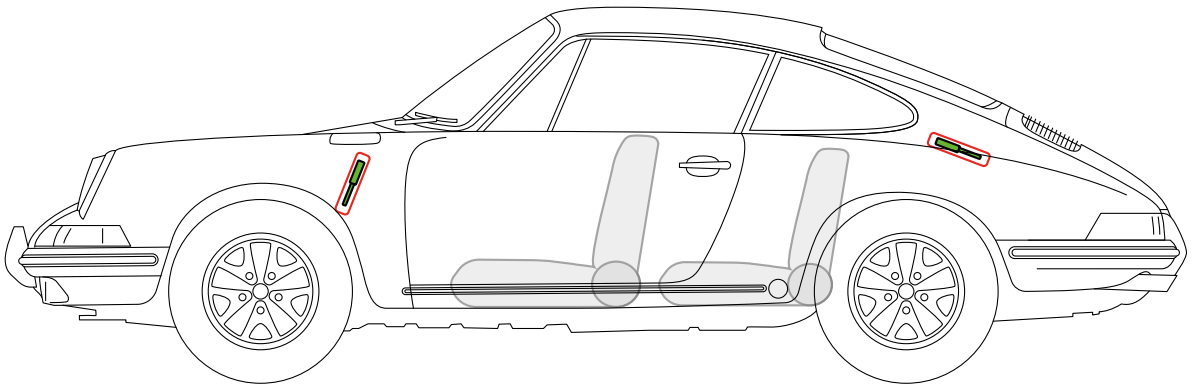
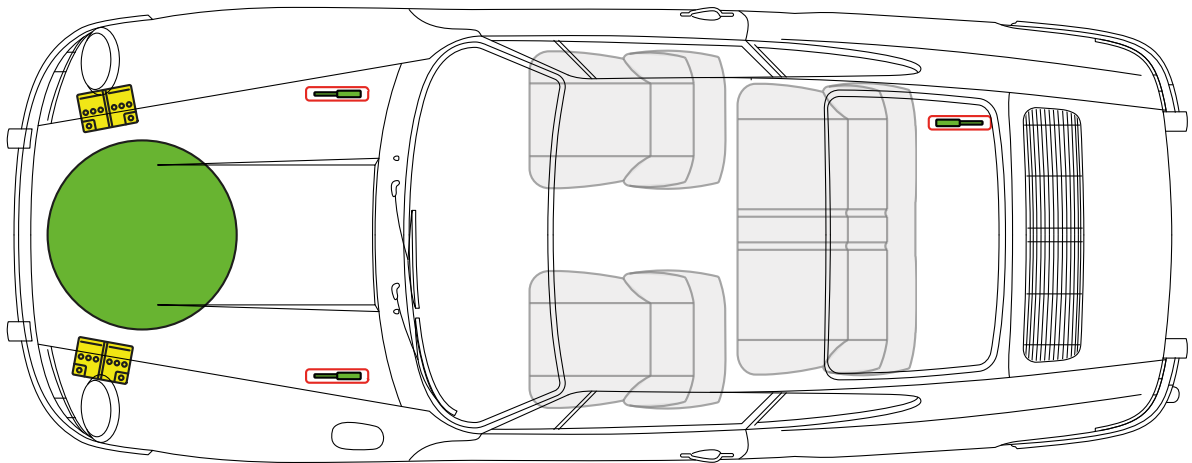

연료 탱크

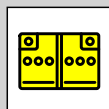

배터리

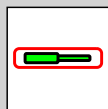

가스 압력 댐퍼



Porsche AG, 912, Targa, 모든 파생 상품

PORSCHE 1965년형에서 1969년형까지,

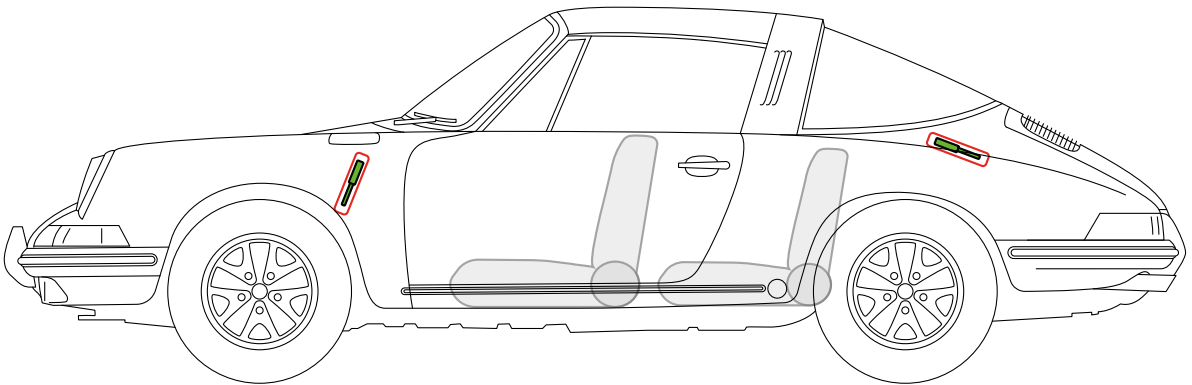
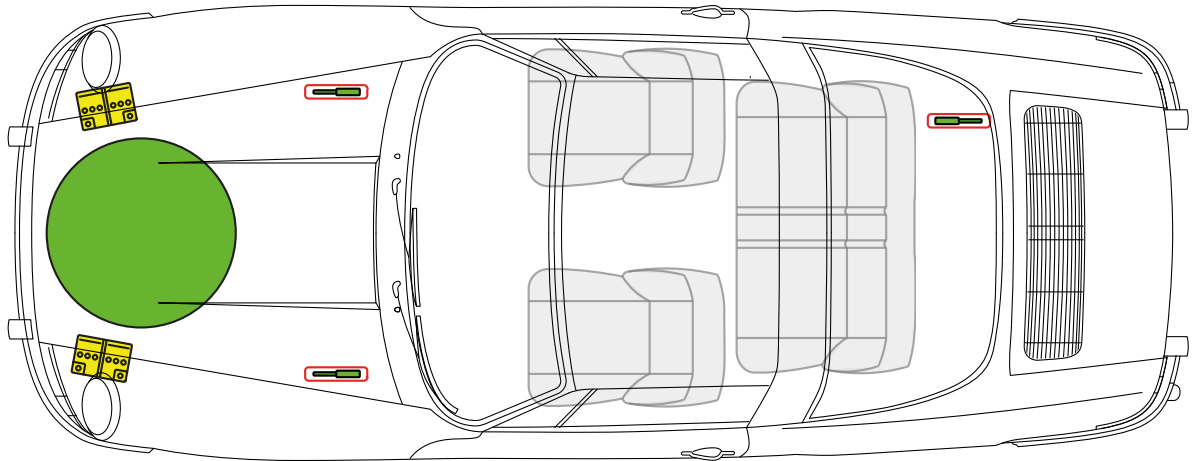

연료 탱크

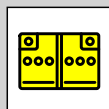

배터리

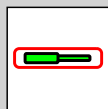

가스 압력 댐퍼



Porsche AG, 914, Targa, 모든 파생 상품

PORSCHE 1970년형에서 1976년형까지,

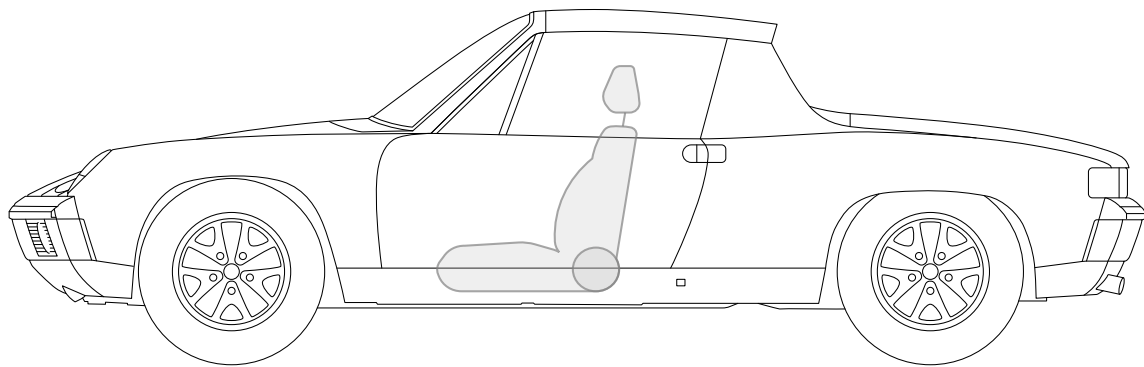
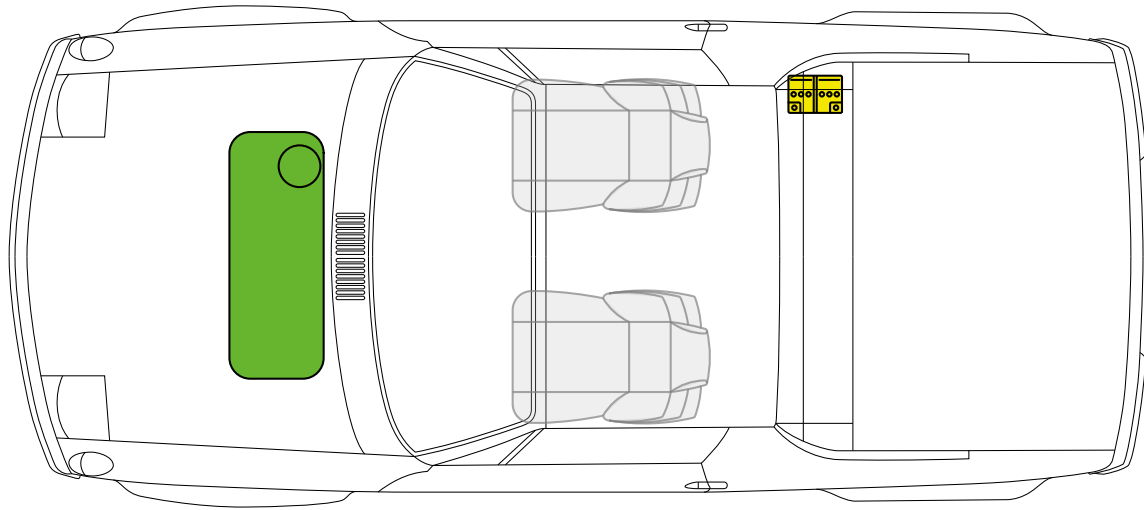

연료 탱크

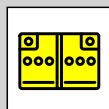

배터리



Porsche AG, 924, Coupé, 모든 파생 상품

PORSCHE 1976년형에서 1988년형까지,

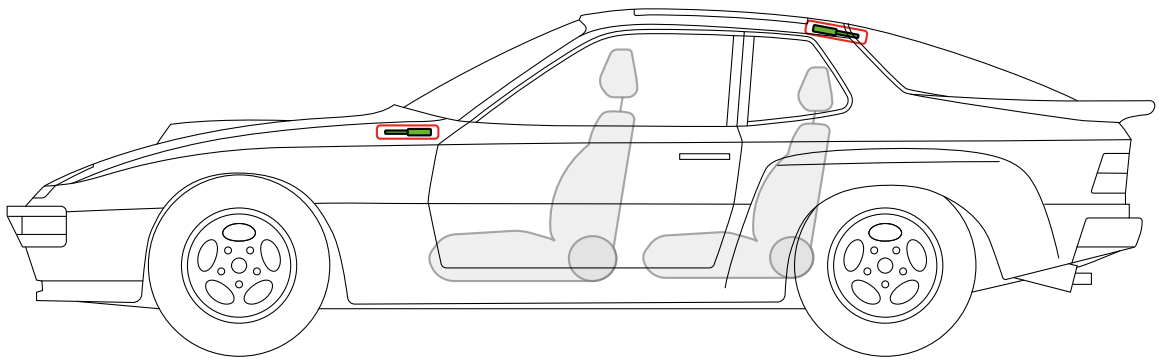
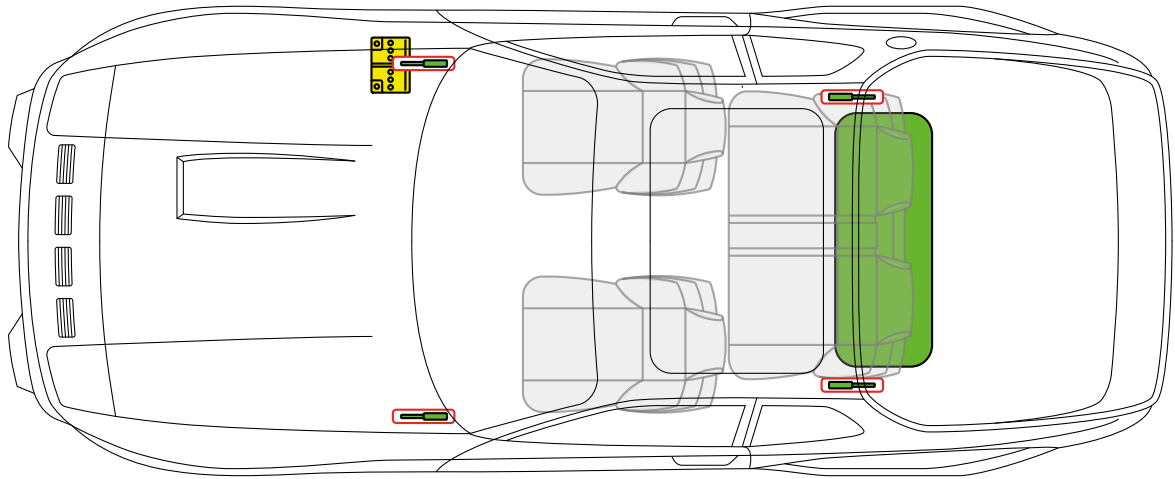

연료 탱크

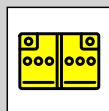

배터리

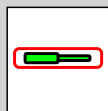

가스 압력 댐퍼



Porsche AG, 928, Coupé, 모든 파생 상품

PORSCHE 1977년형에서 1995년형까지,

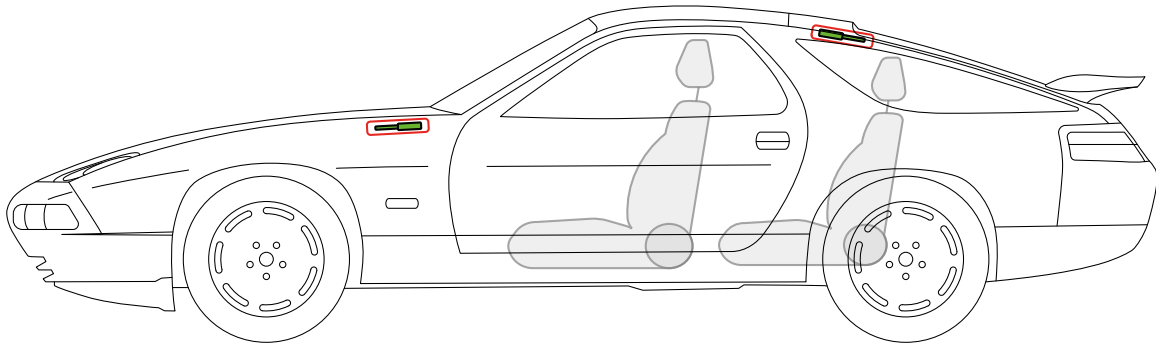
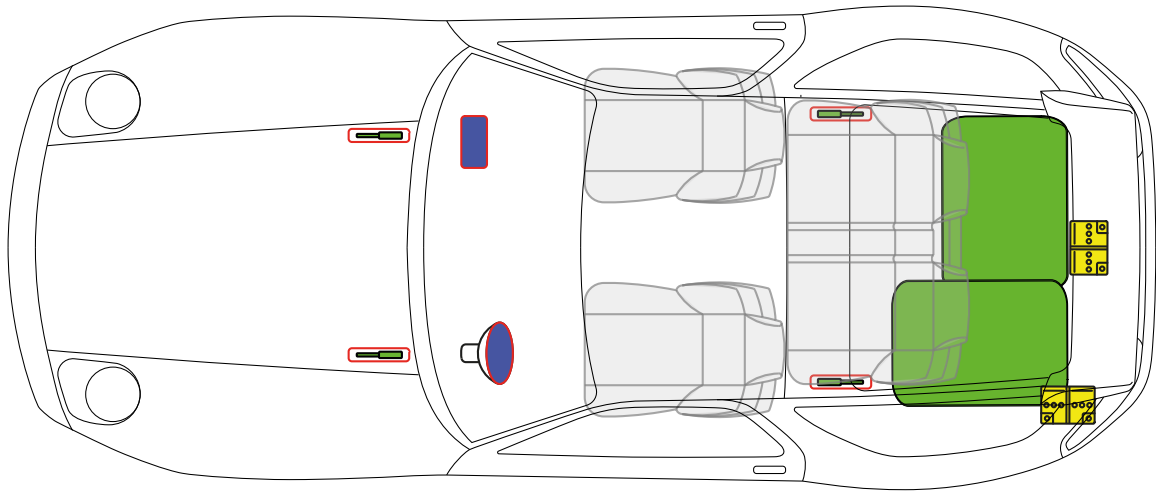

연료 탱크

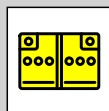

배터리

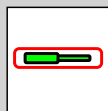

가스 압력 댐퍼

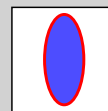

에어백



**Porsche AG, 944, Coupé, Targa,
모든 파생 상품
PORSCHE 1982년형에서 1991년형까지,**

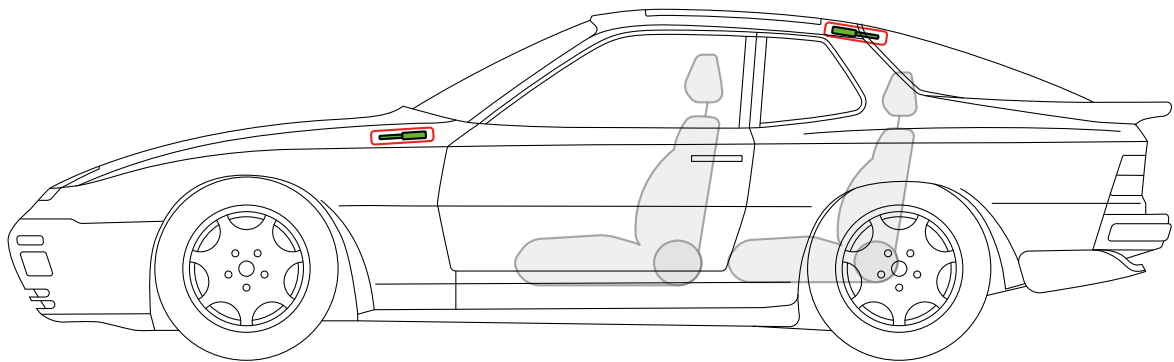
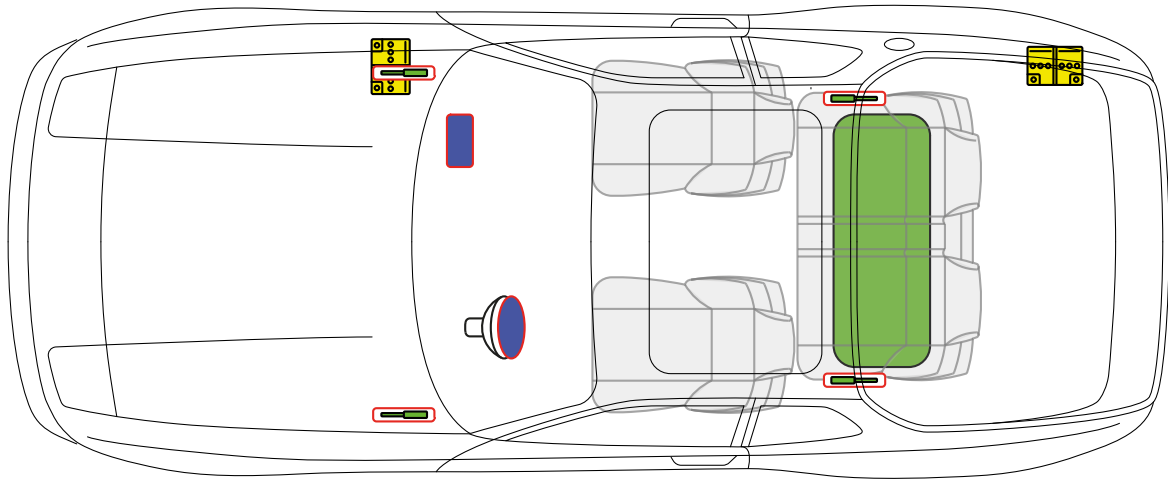
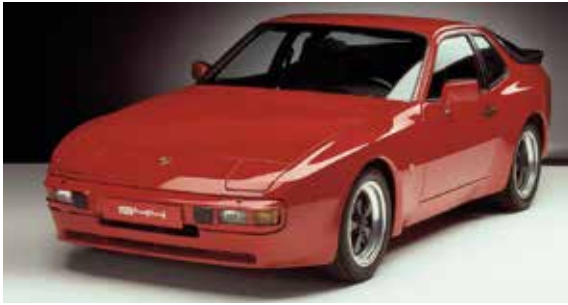

연료 탱크

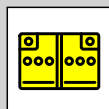

배터리

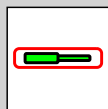

가스 압력 댐퍼

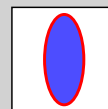

에어백



Porsche AG, 944, Cabriolet, 모든 파생 상품

PORSCHE 1989년형에서 1991년형까지,

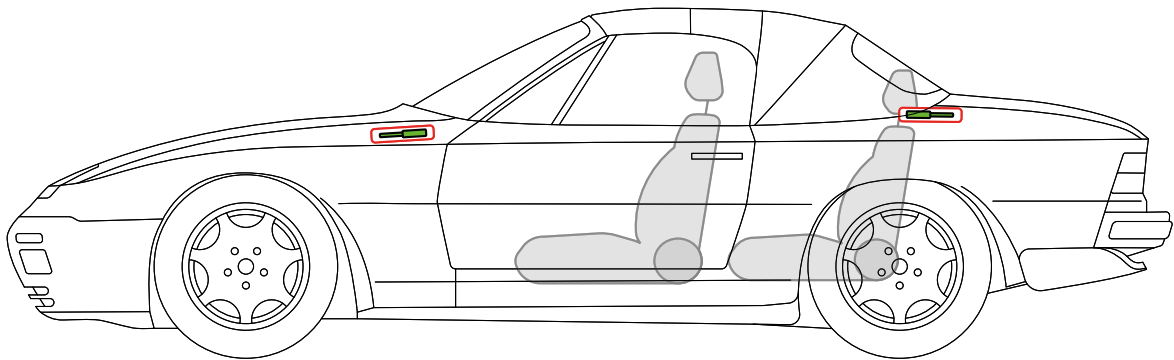
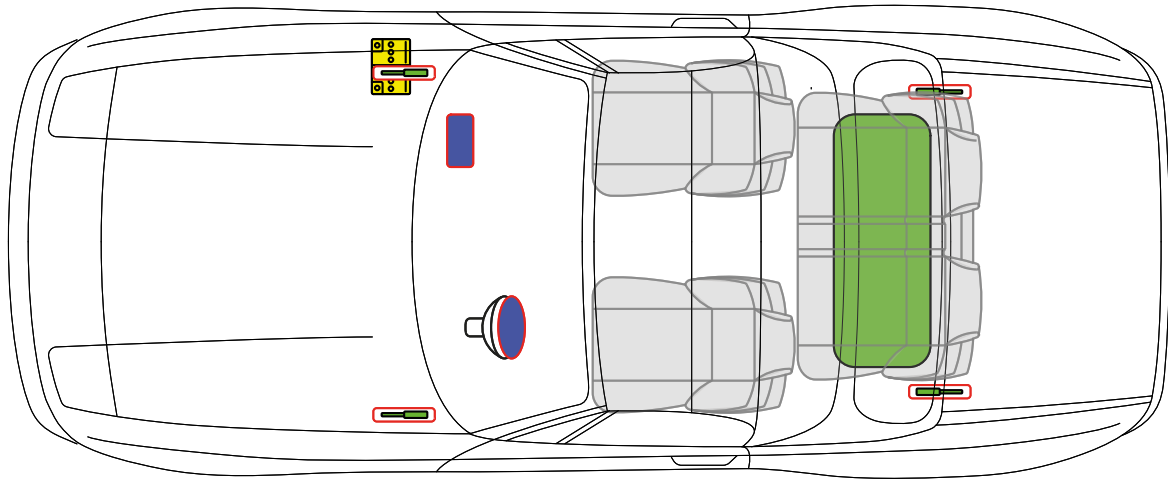

연료 탱크

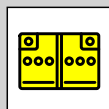

배터리

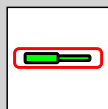

가스 압력 댐퍼

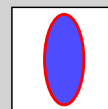

에어백



**Porsche AG, 959, Coupé,
모든 파생 상품**

PORSCHE 1986년형에서 1988년형까지,

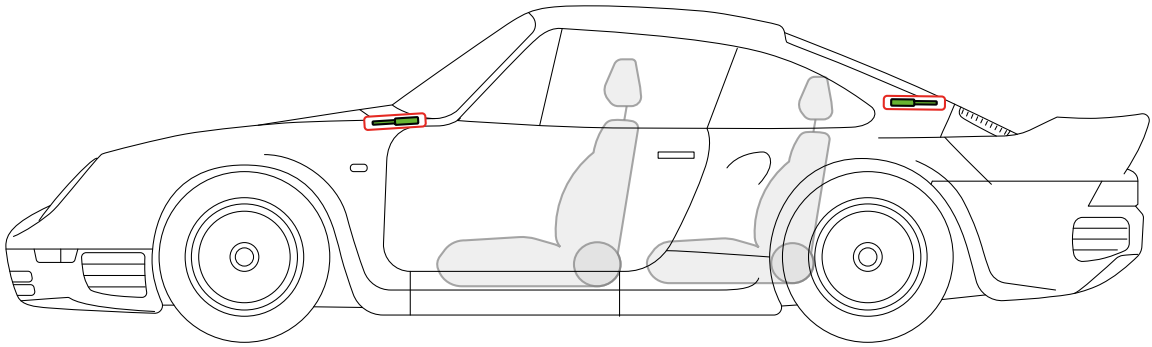
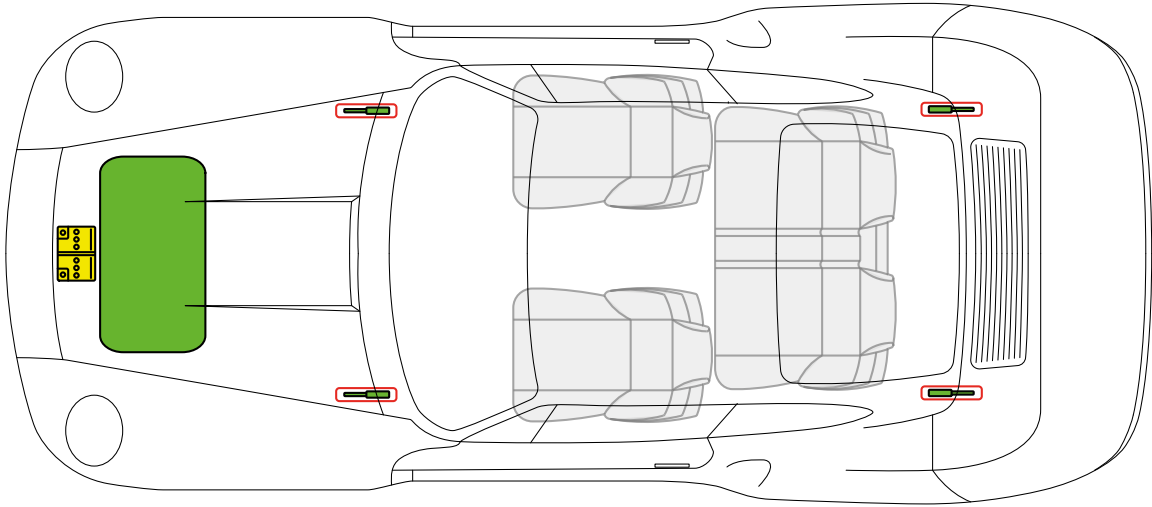

연료 탱크

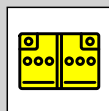

배터리

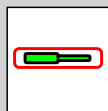

가스 압력 댐퍼



Porsche AG, 964, Coupé, 모든 파생 상품

PORSCHE 1989년형에서 1994년형까지,

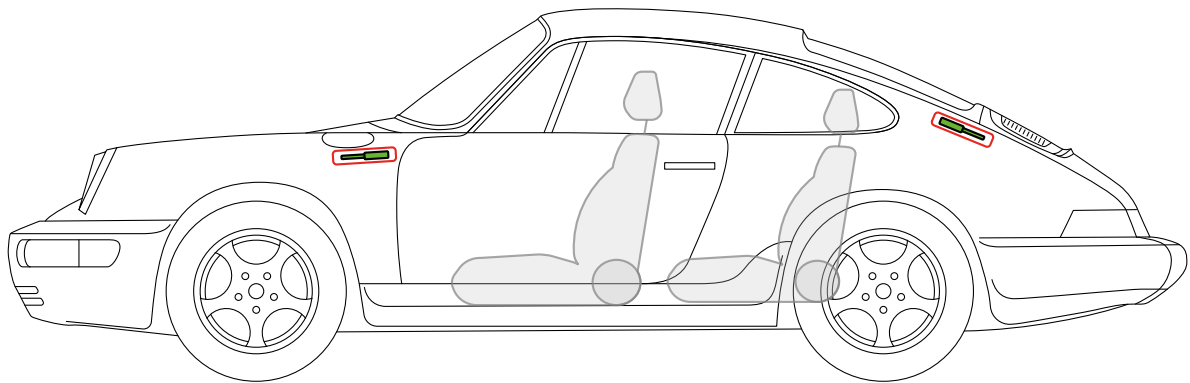
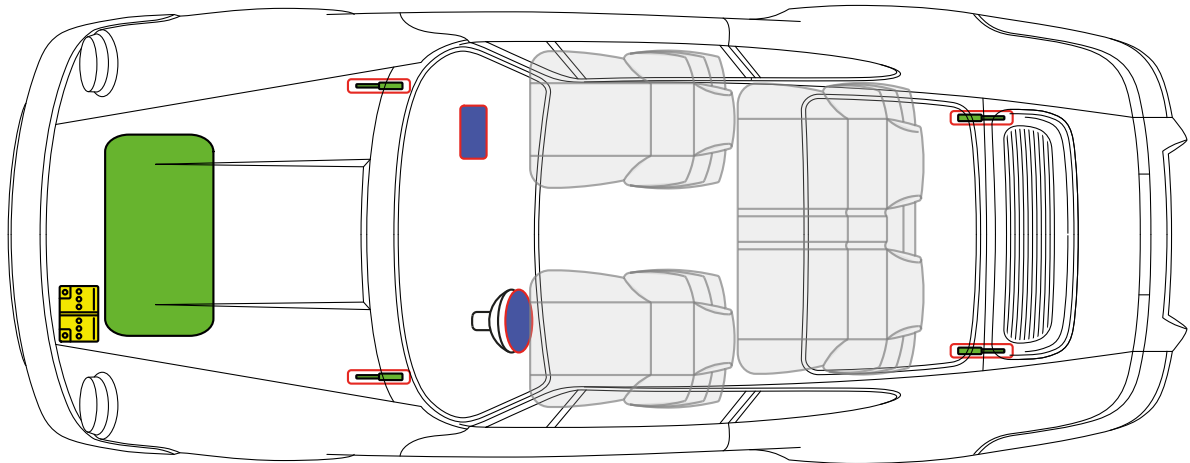
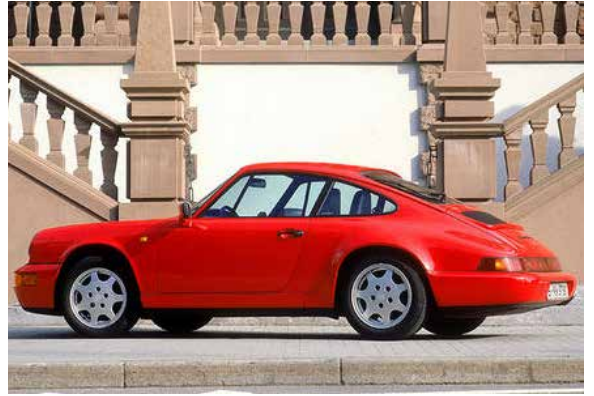
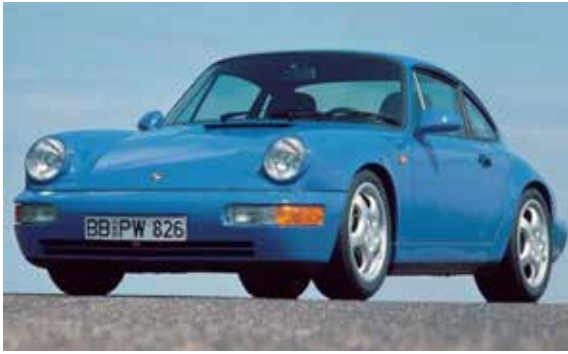

연료 탱크

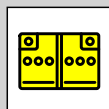

배터리

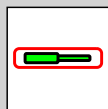

가스 압력 댐퍼

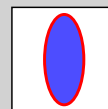

에어백



Porsche AG, 964, Targa, 모든 파생 상품

PORSCHE 1990년형에서 1994년형까지,

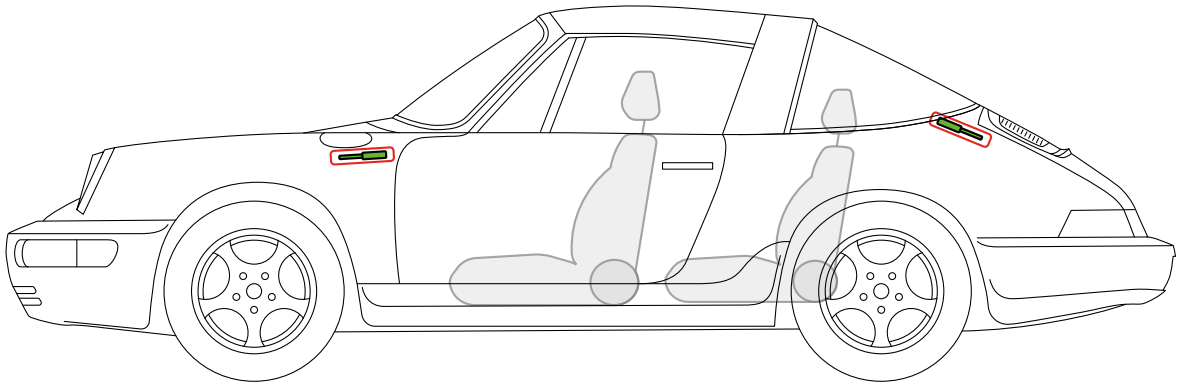
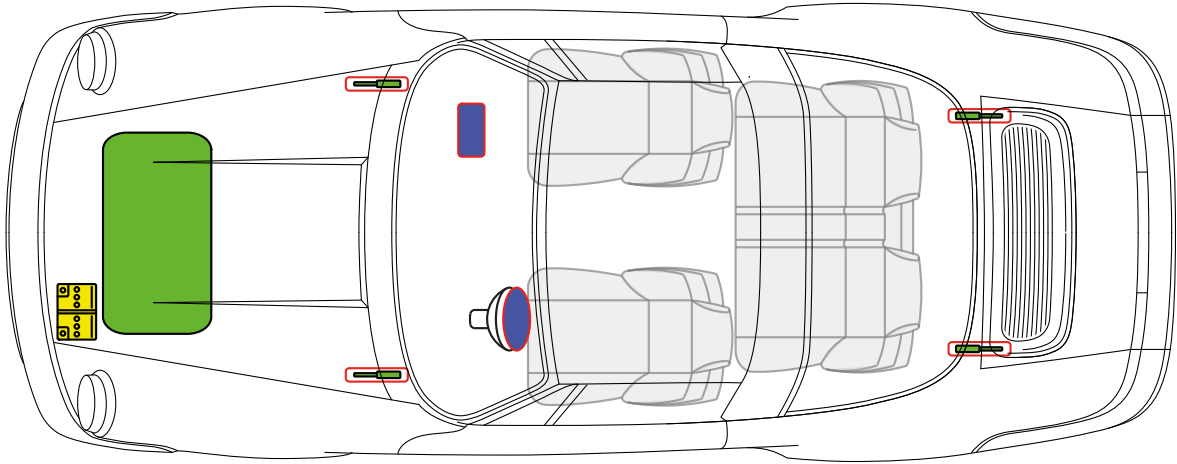

연료 탱크

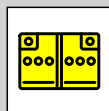

배터리

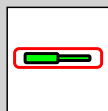

가스 압력 댐퍼

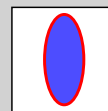

에어백



Porsche AG, 964, Cabriolet, Speedster,

모든 파생 상품

PORSCHE 1990년형에서 1994년형까지,

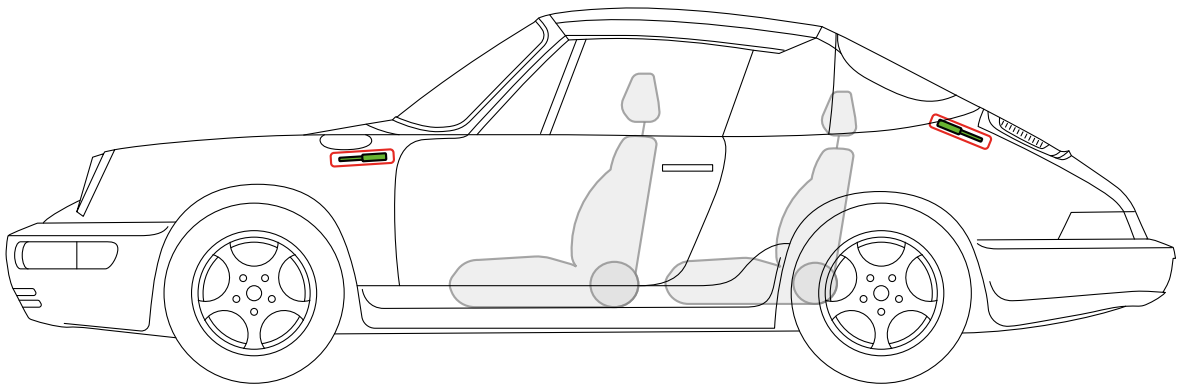
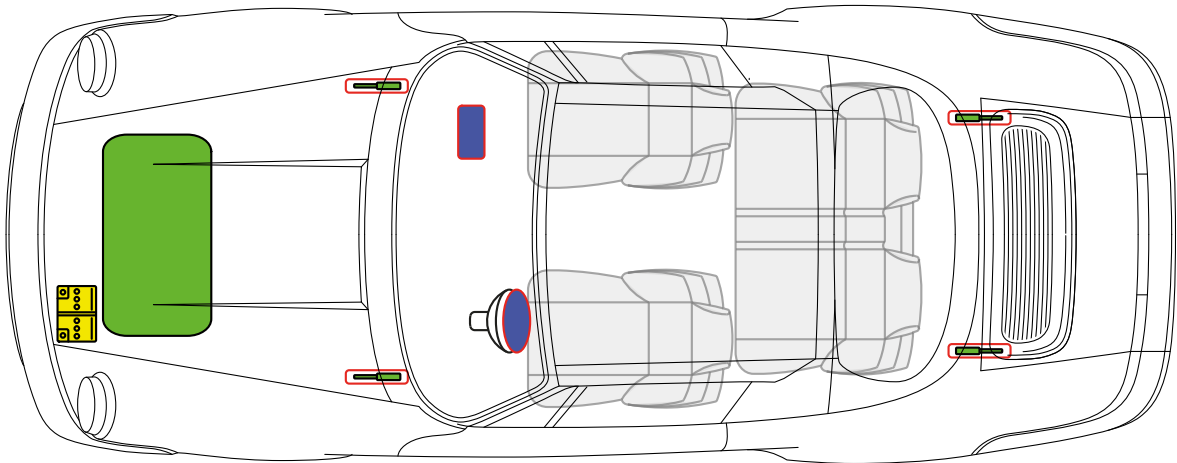

연료 탱크

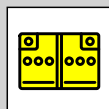

배터리

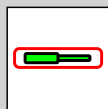

가스 압력 댐퍼

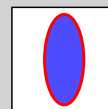

에어백



Porsche AG, 964, Coupé, Turbo, 모든 파생 상품

PORSCHE 1990년형에서 1994년형까지,

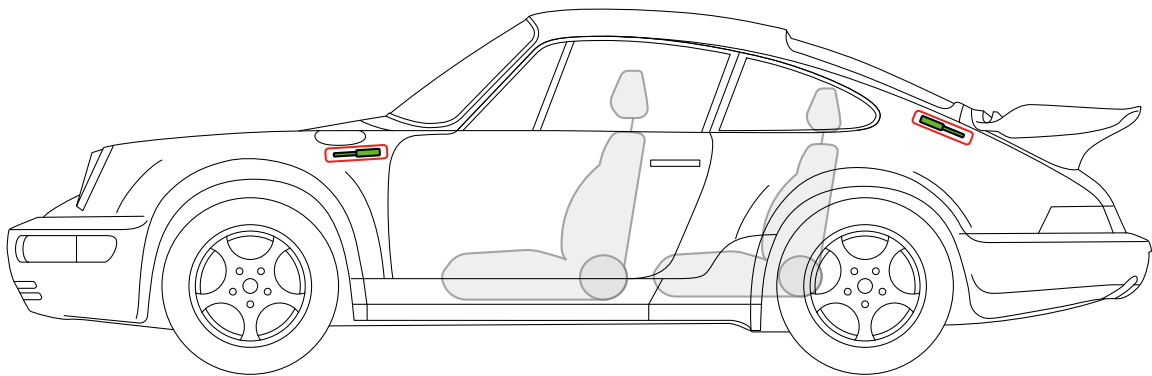
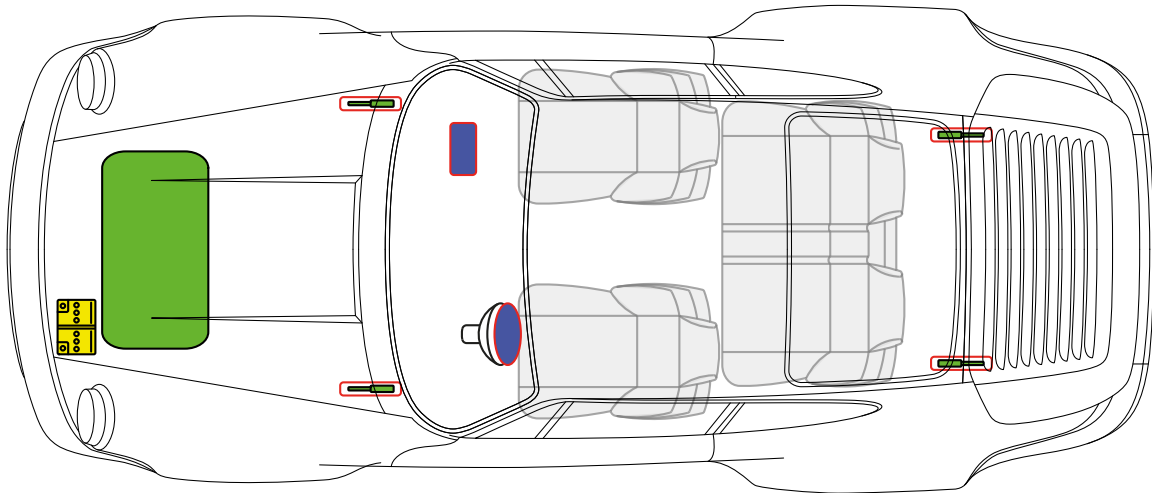
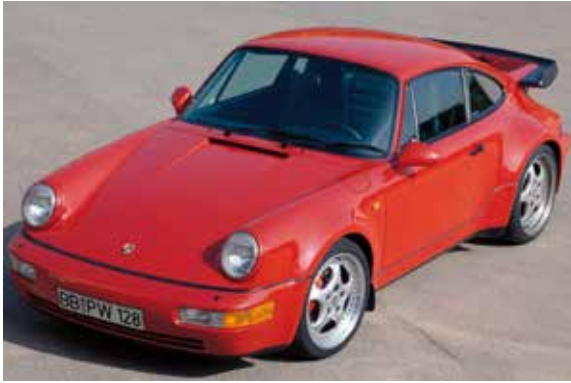

연료 탱크

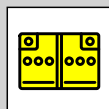

배터리

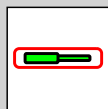

가스 압력 댐퍼

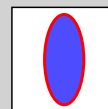

에어백



Porsche AG, 968, Coupé, 모든 파생 상품

PORSCHE 1991년형에서 1995년형까지,

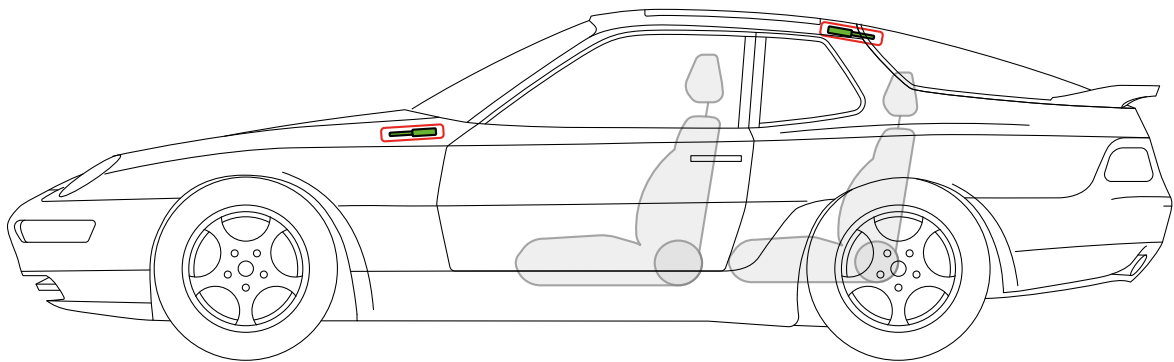
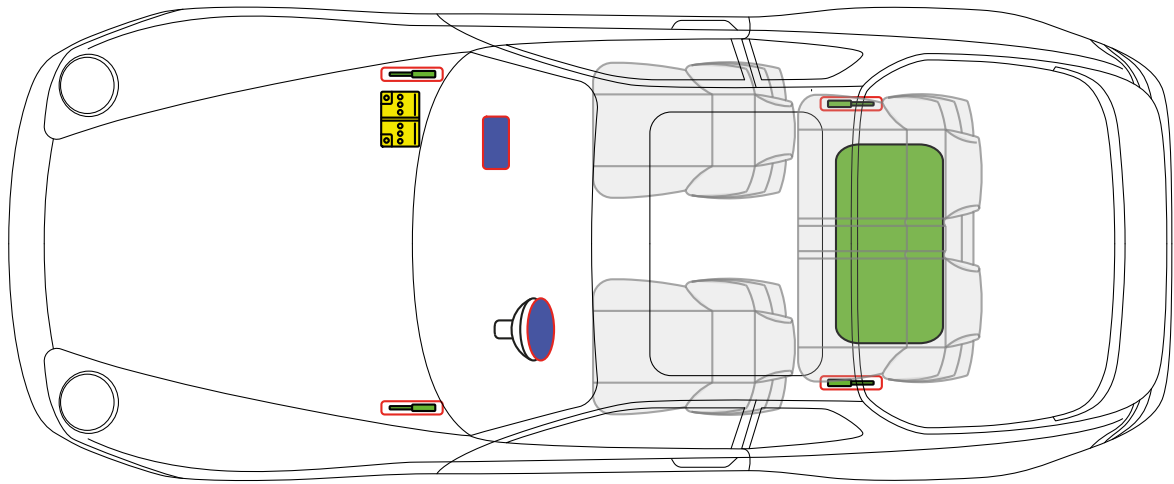

연료 탱크

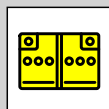

배터리

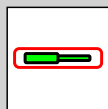

가스 압력 댐퍼

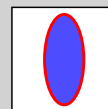

에어백



Porsche AG, 968, Cabriolet, 모든 파생 상품

PORSCHE 1991년형에서 1995년형까지,

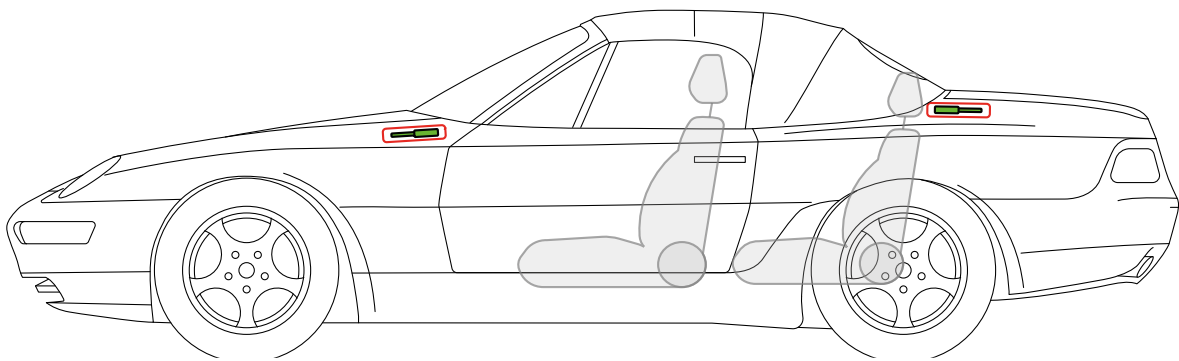
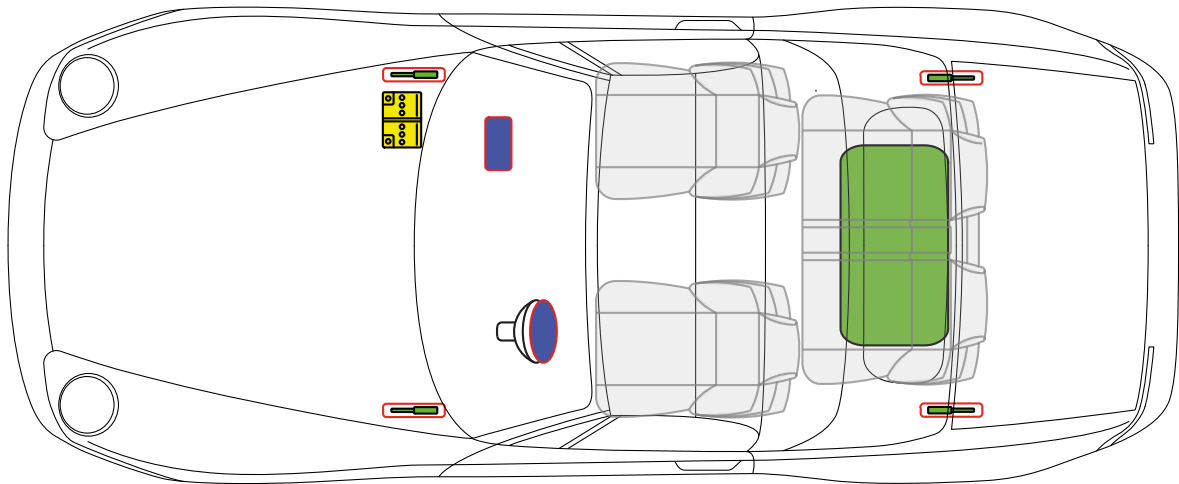

연료 탱크

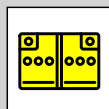

배터리

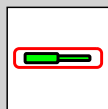

가스 압력 댐퍼

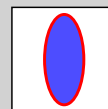

에어백



Porsche AG, 993, Coupé, 모든 파생 상품

PORSCHE 1994년형에서 1998년형까지,

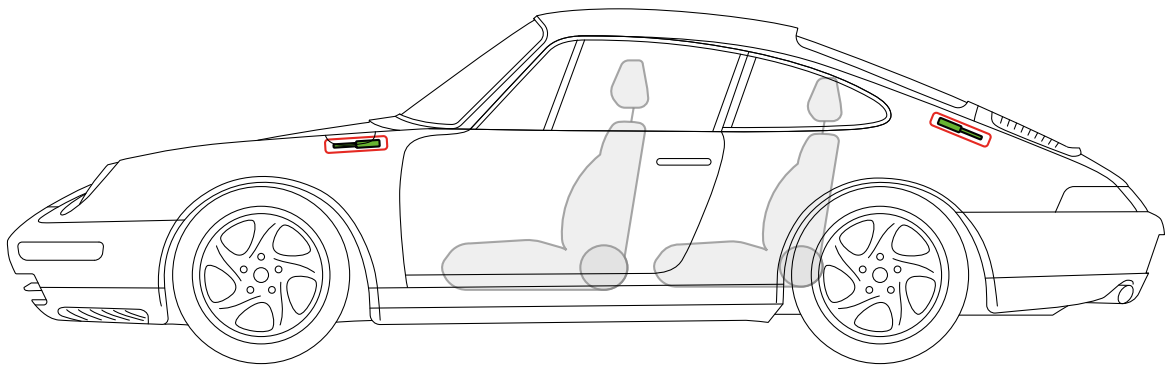
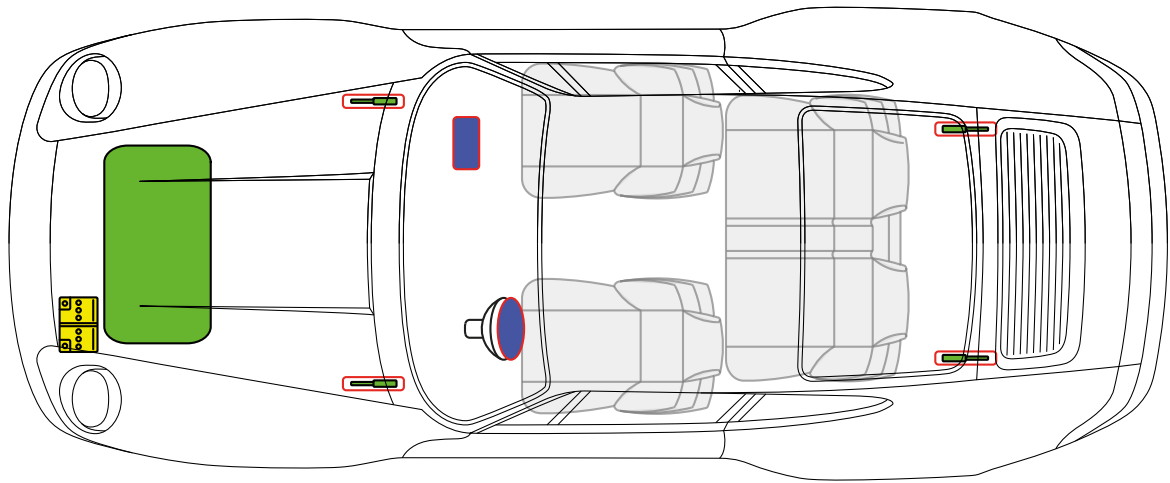

연료 탱크

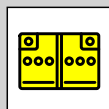

배터리

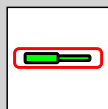

가스 압력 댐퍼

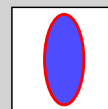

에어백



Porsche AG, 993, Targa, 모든 파생 상품

PORSCHE 1994년형에서 1998년형까지,

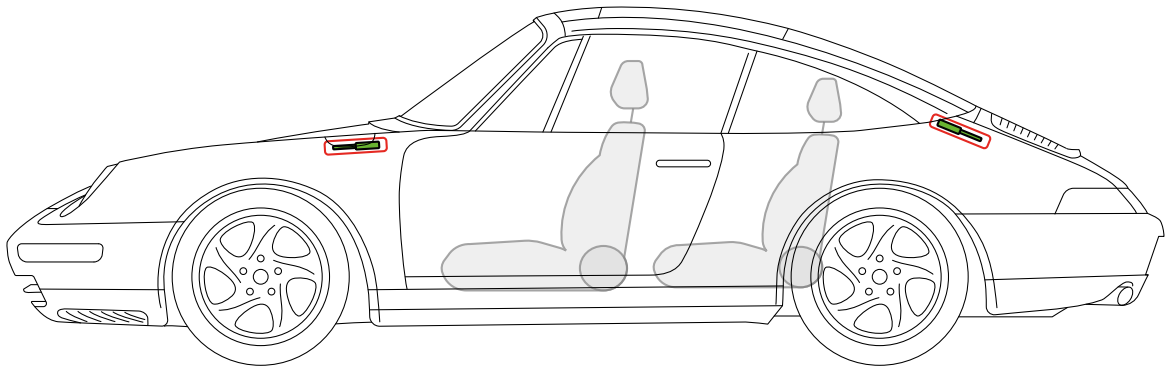
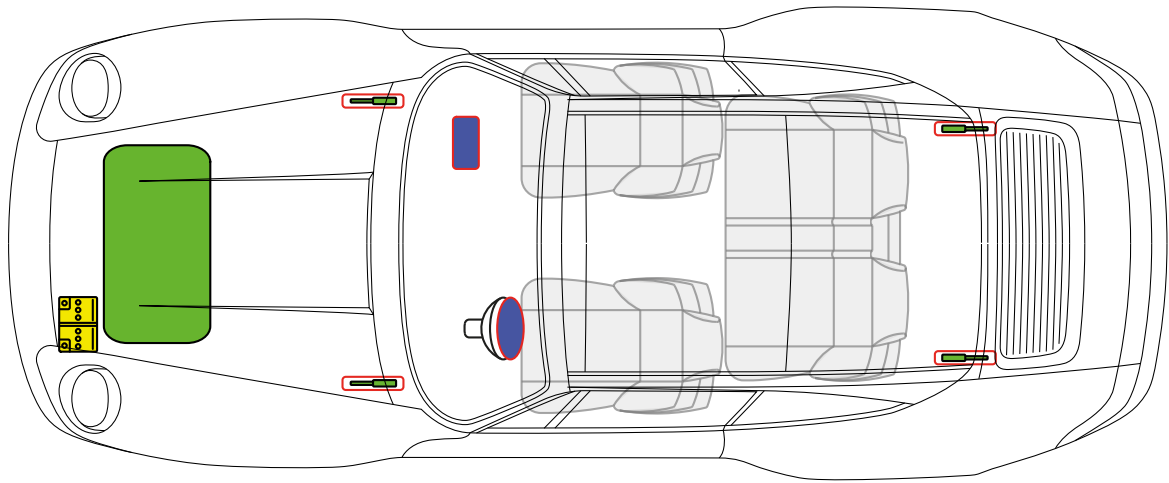

연료 탱크

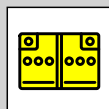

배터리

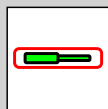

가스 압력 댐퍼

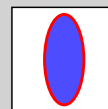

에어백



Porsche AG, 993, Cabriolet, 모든 파생 상품

PORSCHE 1994년형에서 1998년형까지,

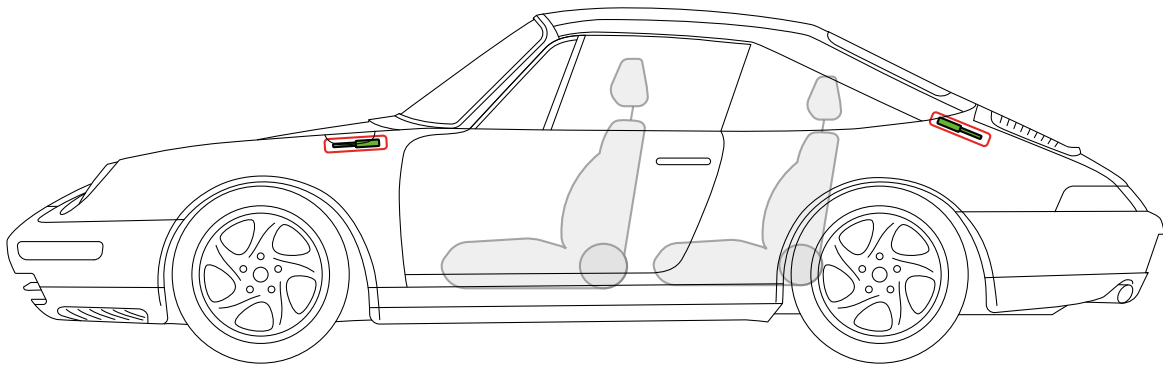
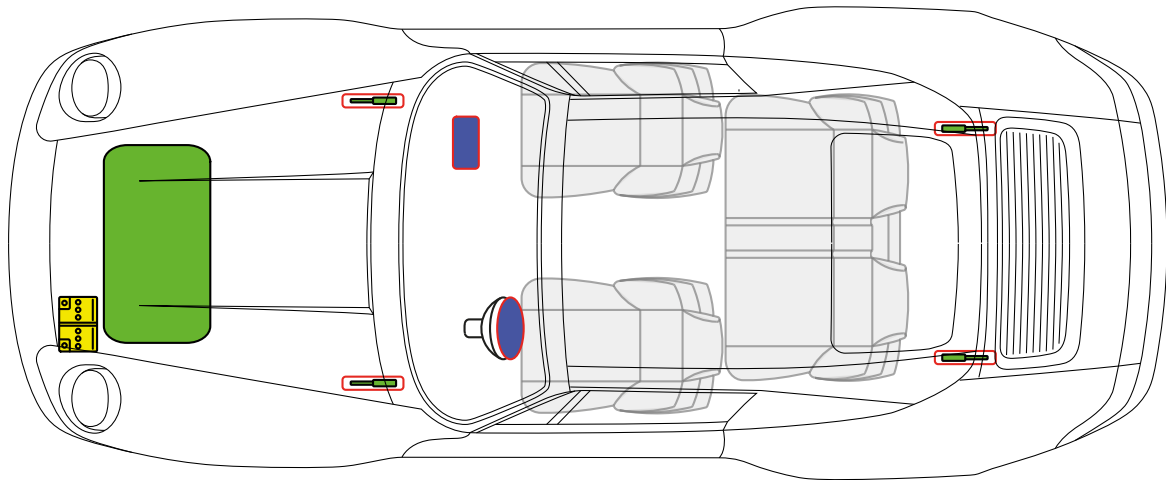

연료 탱크

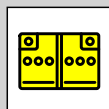

배터리

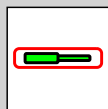

가스 압력 댐퍼

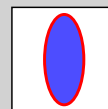

에어백



Porsche AG, 986, Boxster, Cabriolet,

모든 파생 상품

PORSCHE 1997년형에서 2004년형까지,

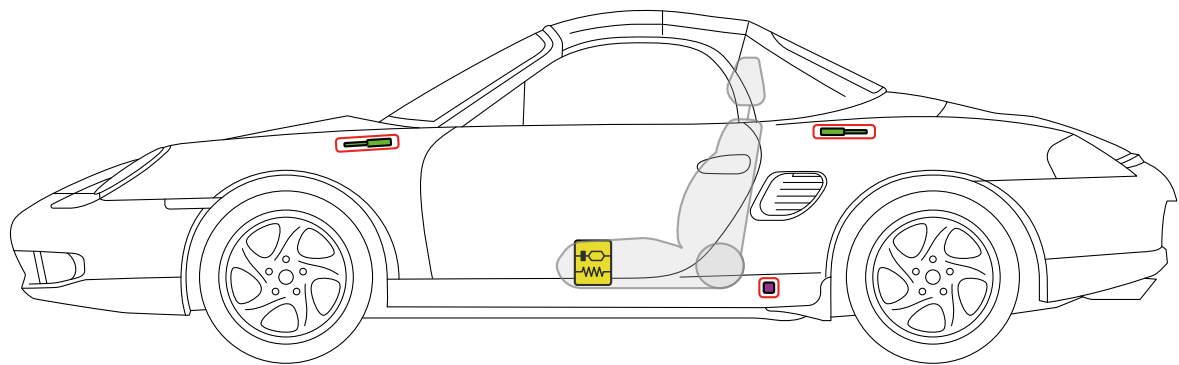
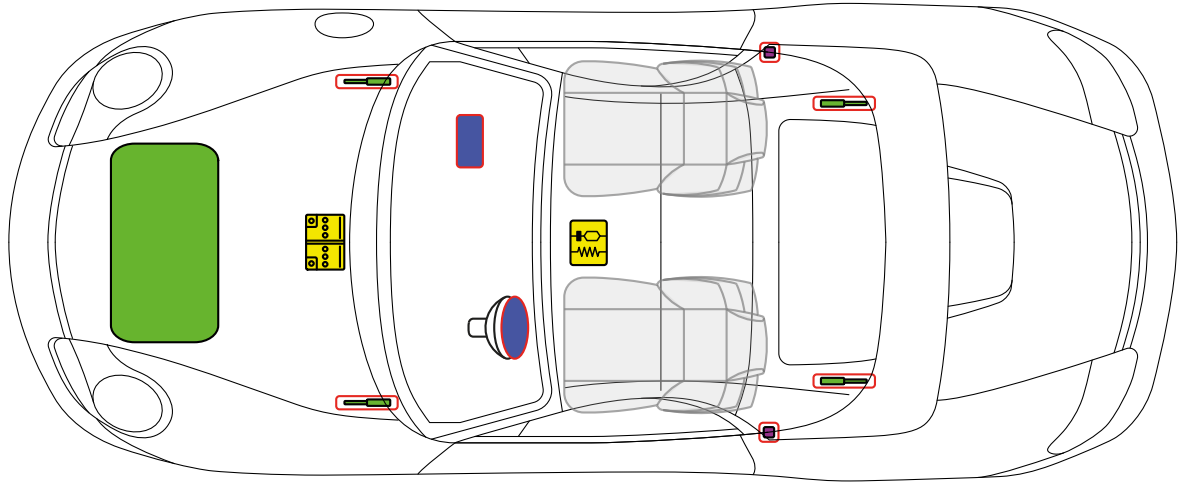

연료 탱크

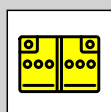

배터리

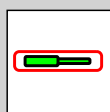

가스 압력 댐퍼

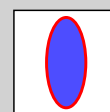

에어백



안전벨트 텐셔너

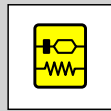





SRS-컨트롤 유닛

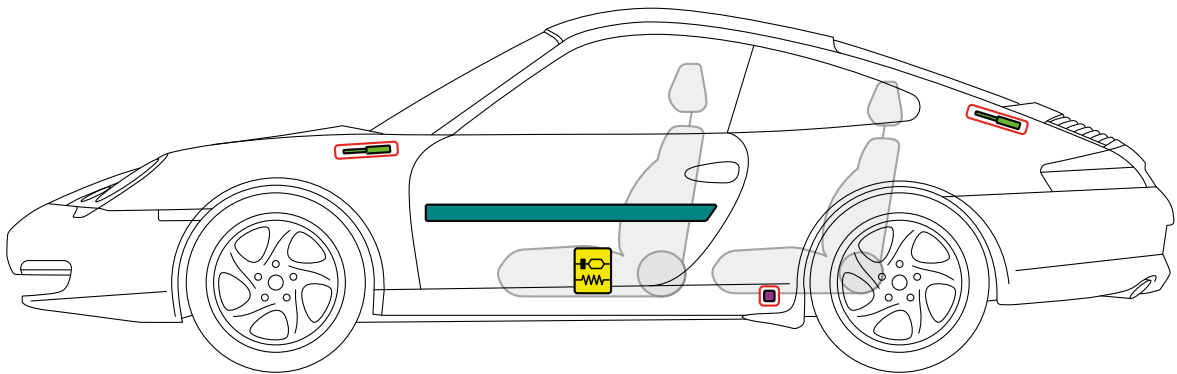
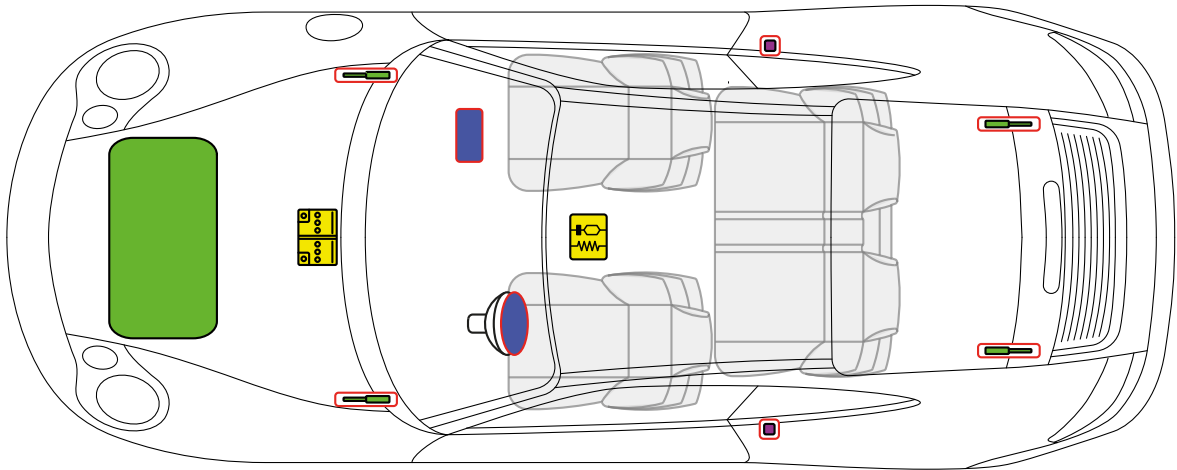
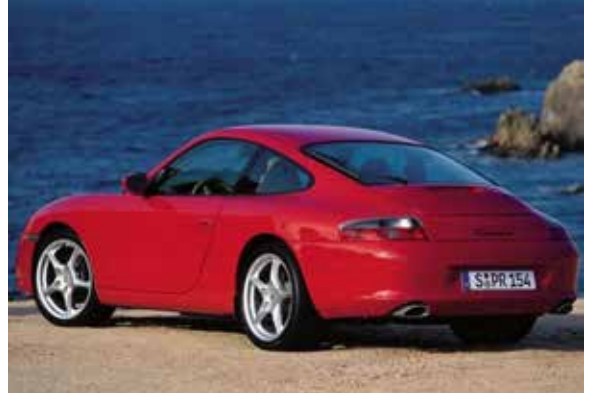

Porsche AG, 996, Coupé, 모든 파생 상품

PORSCHE 1998년형에서 2005년형까지,

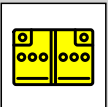
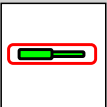
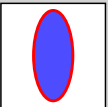

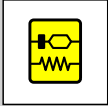
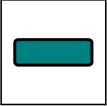
 연료 탱크	 배터리	 가스 압력 댐퍼	 에어백
 안전벨트 텐셔너	 SRS-컨트롤 유닛	 차체-보강재	



Porsche AG, 996, Targa, 모든 파생 상품

PORSCHE 1998년형에서 2005년형까지,

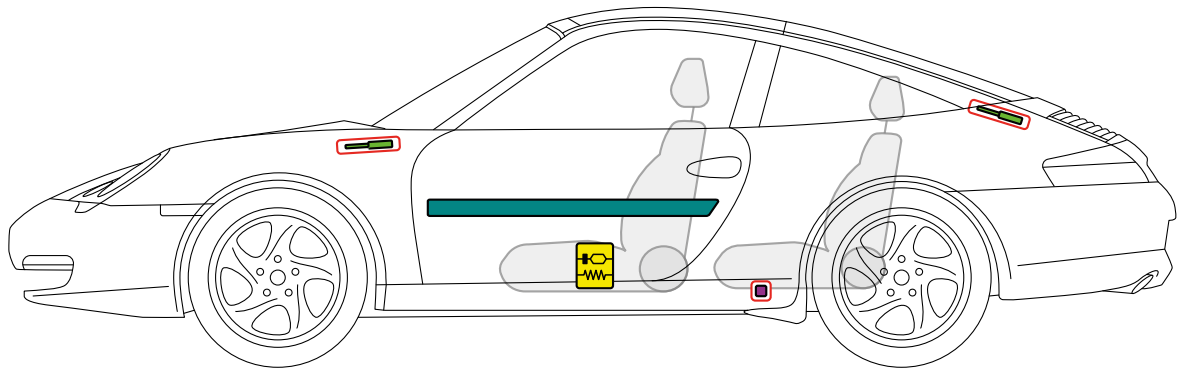
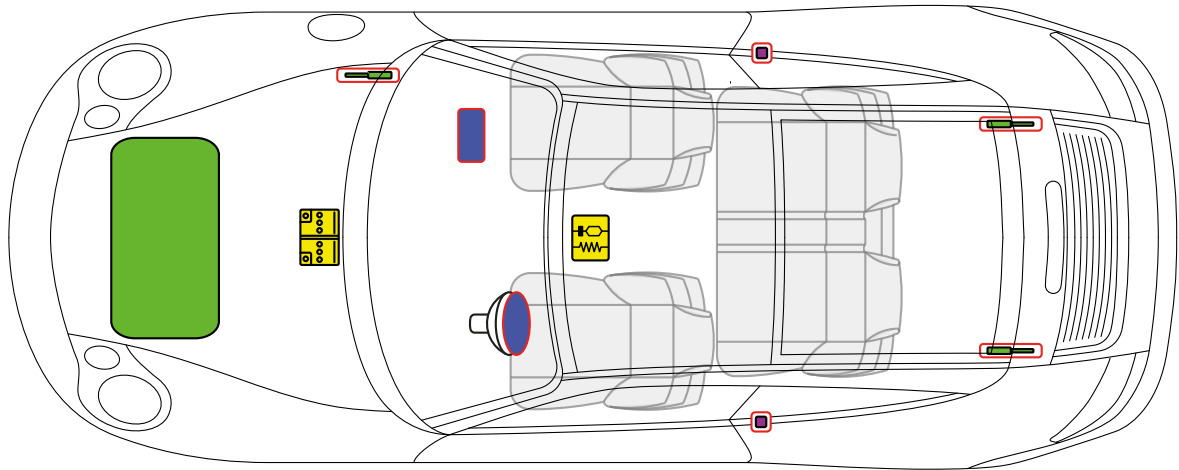

연료 탱크

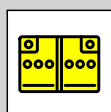

배터리

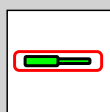

가스 압력 댐퍼

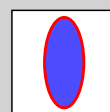

에어백



안전벨트 텐셔너

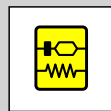

SRS-컨트롤 유닛

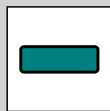





차체-보강재

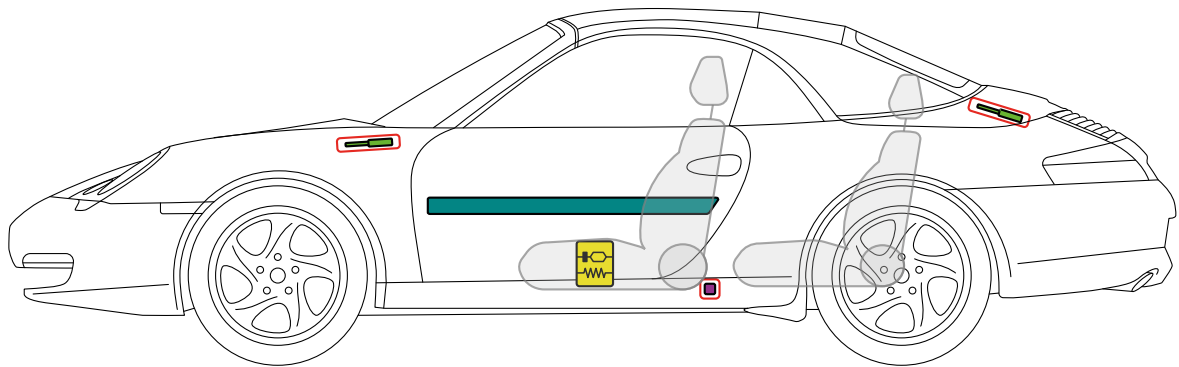
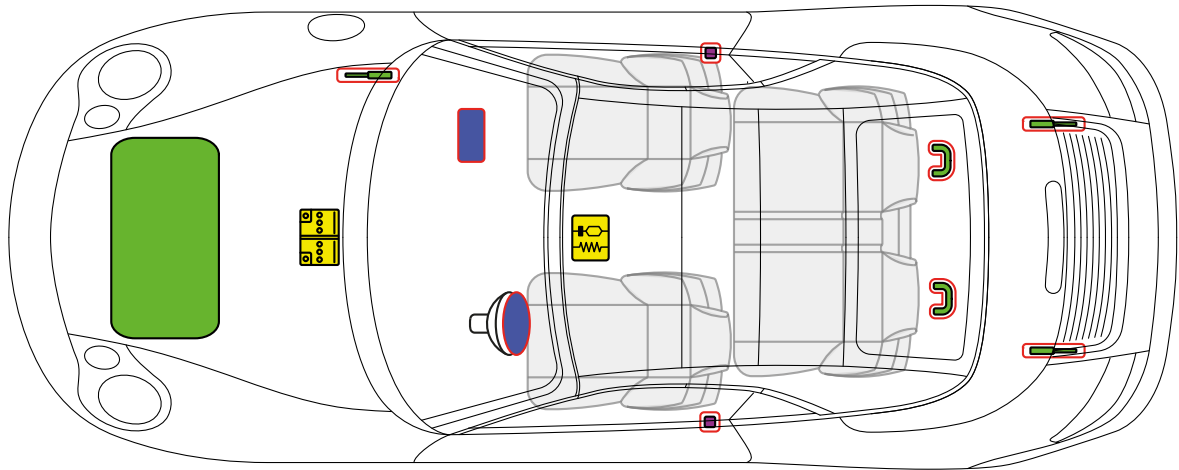

**Porsche AG, 996, Cabriolet,
모든 파생 상품**

PORSCHE 1998년형에서 2005년형까지,

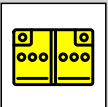
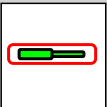
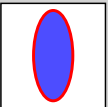

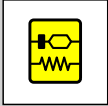
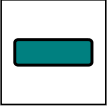
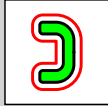
	연료 탱크		배터리		가스 압력 댐퍼		에어백
	안전벨트 텐셔너		SRS-컨트롤 유닛		차체-보강재		롤오버 프로텍션



Porsche AG, 980, GT Carrera, Cabriolet,

모든 파생 상품

PORSCHE 2003년형에서 2006년형까지,

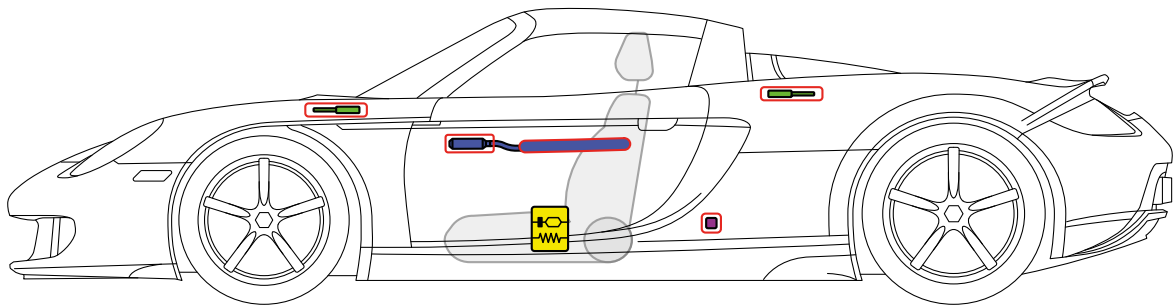
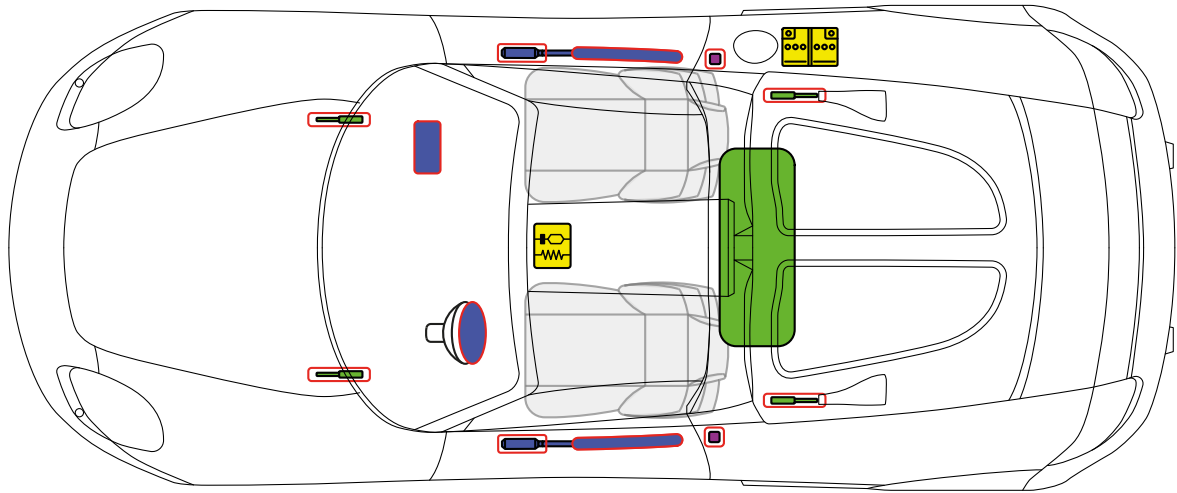

연료 탱크

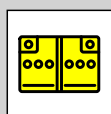

배터리

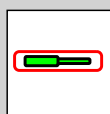

가스 압력 댐퍼

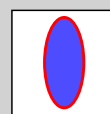

에어백



안전벨트 텐셔너

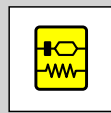

SRS-컨트롤 유닛

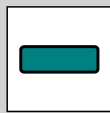

차체-보강재

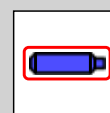

가스 생성기