

Porsche, the Porsche Crest, 911, Tiptronic, PCCB and Tequipment are registered trademarks of Dr. Ing. h.c. F. Porsche AG.

Printed in Germany.

Reprinting, even of excerpts, or duplication of any type is only permissible with the written authorisation of Dr. Ing. h.c. F. Porsche AG.

© Dr. Ing. h.c. F. Porsche AG
Porscheplatz 1
D-70435 Stuttgart

On-board literature

Please always keep this literature in the vehicle and please hand it over to the new owner if you sell your vehicle.

Equipment

Because our vehicles undergo continuous development, equipment and specification may not be as illustrated or described in this Driver's Manual.

Items of equipment are sometimes optional or vary depending on legal requirements or on the country in which the vehicle is sold.

Your Porsche partner will be pleased to advise you on retrofitting such equipment.

Should your Porsche be fitted with any equipment not described in this Manual, your Porsche partner will be glad to provide information concerning correct operation and care of the items concerned.

Because of different legal requirements in individual countries, the equipment in your vehicle may vary slightly from that described in this Driver's Manual.

Suggestions

Do you have any questions, suggestions or ideas for your vehicle or for the on-board literature?

Please write to us:

Dr. Ing. h.c. F. Porsche AG
Vertrieb Customer Relations
Porschestraße 15-19
71634 Ludwigsburg

Contents

There is a summary of topics with page numbers at the beginning of each main chapter.

Index

There is a detailed, alphabetical index at the end of this Driver's Manual.

Technical modifications

Modifications may be carried out on your vehicle only if approved by Porsche.

This ensures that your Porsche will remain reliable and safe to drive, and that it will not be damaged as a result of the modifications.

Your Porsche partner will be pleased to advise you.

Safety notes!

- ▷ Only use genuine Porsche spare parts for your vehicle or spare parts of similar quality which have been manufactured according to the specifications and production requirements of Porsche. These parts are available from your Porsche partner or a qualified specialist workshop. Accessories which are relevant to safety should not be used unless they have been obtained from the Porsche Tequipment product range or have been tested and approved by Porsche. Your Porsche partner will be pleased to advise you and answer any of your questions.

However, the use of other parts or accessories may adversely affect the safety of your vehicle, and Porsche can take no responsibility for any loss or damage caused by their use. Even if the supplier of other accessories or parts is a recognised supplier, the safety of your vehicle may still be affected if such items are installed. Due to the large variety of products offered in the accessory market, it is not possible for Porsche to inspect and approve every one.

- ▷ In addition, please note that the use of replacement parts which are not approved by Porsche may also detrimentally affect the Warranties relating to your vehicle.

- ▷ Regularly check your vehicle for signs of damage. Damaged or missing aerodynamic components such as spoilers or underside panels affect driving behaviour and must therefore be replaced immediately.
-

Setting and operating vehicle components when driving

Warning!

Operating the on-board computer, the radio, the navigation system, the telephone or other equipment while driving is dangerous and can result in an accident. This could distract you from the traffic and cause you to lose control of the vehicle.

- ▷ Operate these components while driving only if the traffic situation allows you to do so safely.
 - ▷ Carry out any complicated operating or setting procedures only while the vehicle is stationary.
-

Porsche Ceramic Composite Brake (PCCB)

The high-performance brake system is designed for optimal braking effect at all speeds and temperatures.

Certain speeds, braking forces and ambient conditions (such as temperature and humidity) may therefore cause the brakes to squeal.

Wear on different components of the braking system, e.g. brake pads or brake discs, depends to a great extent on the individual driving style and the conditions of use and therefore cannot be expressed in actual miles on the road.

The values communicated by Porsche are based on normal operation adapted to traffic. Wear increases considerably when the vehicle is driven on race tracks or through an aggressive driving style.

- ▷ Before using your vehicle in this way, please consult your Porsche partner about the guidelines which currently apply.

Ground clearance



Caution!

Risk of damage.

The vehicle may touch the ground as a result of the small ground clearance.

- ▷ Drive carefully and slowly on steep slopes (e.g. in multi-storey car parks), kerbs, uneven roads, platform lifts, etc.
 - ▷ Avoid steep ramps.
 - ▷ When towing and when recovering by a towing vehicle, pay attention to the small ground clearance.
-

Sport tyres

Sport tyres (ultra high performance tyres) are approved for use on public highways and comply with all statutory requirements and safety criteria. The design of the tyre is also geared towards use on racing circuits (driver safety training courses, sports driving schools, Club Sport events) and provides distinct advantages here in terms of dry grip and wear compared to conventional road tyres.

The major features are a reduced tread depth, a special tread pattern and carcass.

The design features of these sports tyres result in the following effects compared with other summer tyres when used under normal driving conditions:

- Due to the lower tread depth, sports tyres can reach their wear limit earlier. As for all tyres, the possible driven distance depends on the individual driving style and service conditions.
- On wet roads, in particular in aquaplaning situations (stagnant water, puddles, lane grooves...), it is advisable to exercise caution because of the lower tread depth and to adapt speed accordingly (as is generally the case for normal road tyres and with reduced tyre tread depths).
- The higher performances in the limit range require that attention be adapted to suit, because any infringement of an upper limit range also harbours greater risks.
- Change to winter tyres when external temperatures drop below 7 °C.
- ▷ Notify anyone using your car of these characteristics and possible effects.



Danger!

Risk of accident through loss of road surface contact, control over the vehicle and braking ability. The reduced tyre tread depth means that there is an increased risk of aquaplaning on wet roads.

- ▷ When driving on wet or mud-covered roads reduce speed significantly.
-



Danger!

Risk of accident. Due to the lower tread depth, sports tyres can reach their wear limit earlier.

- ▷ Check the tread depth regularly.
-

Recycling

Only in countries of the European Union: Returning end-of-life vehicles

Porsche AG will arrange for your old Porsche to be recycled in an environmentally compatible manner, free of charge.

To return your vehicle and obtain the relevant Certificate of Destruction, please consult your Porsche partner, which will gladly assist you in disposing of your old vehicle.

Controls, Safety, Instruments	8 - 140
Shifting Gears	142 - 148
Mobile Roofs	150 - 174
Maintenance, Care	176 - 196
Practical Tips, Minor Repairs	198 - 232
Vehicle Identification, Technical Data	234 - 246
Index	247 - 251

Controls, Safety, Instruments

Before Driving Off	8	Porsche Stability Management (PSM).....	48	Direction Indicator/High Beam/ Parking Light/Headlight Flasher Stalk	115
Tips for Running In	8	Porsche Active Suspension Management (PASM).....	51	Windscreen Wiper/Washer Stalk.....	116
Keys	10	Retractable Rear Spoiler.....	52	Cruise Control	119
Key with Radio Remote Control	11	Parking Aids	54	Hazard Warning Lights	121
Central Locking	13	Porsche Traction Management (PTM).....	56	Automatic Air-Conditioning System	122
Doors	16	Interior Lights	57	Central and Side Vents	125
Door Oddments Tray.....	16	Controls, Instruments	58	Heated Rear Window/Door Mirror Heating.....	126
Theft Protection.....	16	Ignition Lock/Steering Lock	60	Cupholder	127
Alarm System, Passenger Compartment Monitoring System	17	Starting and Stopping the Engine	62	Ashtray	129
Power Windows	18	Instrument panel.....	64	Cigarette Lighter.....	129
Door Mirrors.....	20	Engine Oil Temperature	66	Storage.....	130
Automatic Anti-Dazzle		Cruise Control Indicator Light	66	Luggage Compartment Lid and Engine Compartment Lid	132
Interior and Door Mirrors	21	Instrument Illumination.....	66	Luggage Compartment.....	134
Door Mirror Heating/.....		Trip Counter	67	Car Telephones and 2-Way Radios.....	135
Heated Rear Window	22	Speedometer	68	Antenna.....	136
Seat adjustment	23	Changing Over Between Kilometres/Miles.....	68	Porsche Communication Management (PCM)	136
Seat memory	25	Tachometer.....	69	Fire Extinguisher	137
Seat Heating	27	Direction Indicator.....	69	HomeLink.....	138
Rear Seat Backrests	28	High Beam	69		
Steering Wheel Adjustment.....	28	Cooling System	70		
Multi-Functional Steering Wheel	29	Tiptronic S	71		
Sun visors.....	30	Fuel	72		
Seat Belts	31	Clock	73		
Child Restraint System	33	Outside Temperature	73		
Airbag Systems	38	Engine Oil Pressure.....	74		
Roll-Over Protection	40	Emission Control.....	75		
Handbrake	41	On-Board Computer (BC)	76		
Footbrake	42	Light Switch	114		
ABS Brake System.....	44	Home mode	114		
Sport Mode	46	Headlight Beam Adjustment	115		

Before Driving Off

- ▷ Check the filling pressure, tread and condition of all tyres.
- ▷ Clean headlight lenses, rear lights, direction indicators and windows.
- ▷ Check operation of headlights, brake lights and direction indicators with the ignition switched on.
- ▷ Check operation of warning lights and indicator lights with ignition switched on and engine switched off.
- ▷ Ensure that fuel supply is adequate.
- ▷ Adjust interior and door mirrors for proper vision to the rear.
- ▷ Fasten seat belts – driver and passengers.
- ▷ Check all fluid levels regularly between service intervals as well.

Tips for Running In

The following tips will be helpful in obtaining optimum performance from your new Porsche.

Despite the most modern, high-precision manufacturing methods, the “wearing in” of moving parts with each other cannot be completely avoided. This wearing in occurs mainly in the first 3,000 km (1,865 miles).

During the first 3,000 km (1,865 miles) you should:

- ▷ Preferably take longer trips.
- ▷ Avoid frequent cold starts with short-distance driving whenever possible.
- ▷ Not participate in motor racing events, sports driving schools or similar.
- ▷ Avoid high engine speeds, especially when the engine is cold.

Oil and fuel consumption

The oil and fuel consumption may be somewhat higher than normal during the running-in period.

- ▷ Please observe the chapter “TECHNICAL DATA” on page 236.

Bedding in new brake pads and brake discs

New brake pads and brake discs have to be “bedded in”, and therefore only attain optimal friction when the vehicle has covered several hundred km or miles.

The slightly reduced braking ability must be compensated for by pressing the brake pedal harder. This also applies whenever the brake pads or brake discs are replaced.

Running in new tyres

- ▷ Please note: new tyres at first do not possess their full road-holding ability. The new tyres should therefore be broken in by driving at moderate speeds for the first 100 - 200 km (60 - 120 miles).

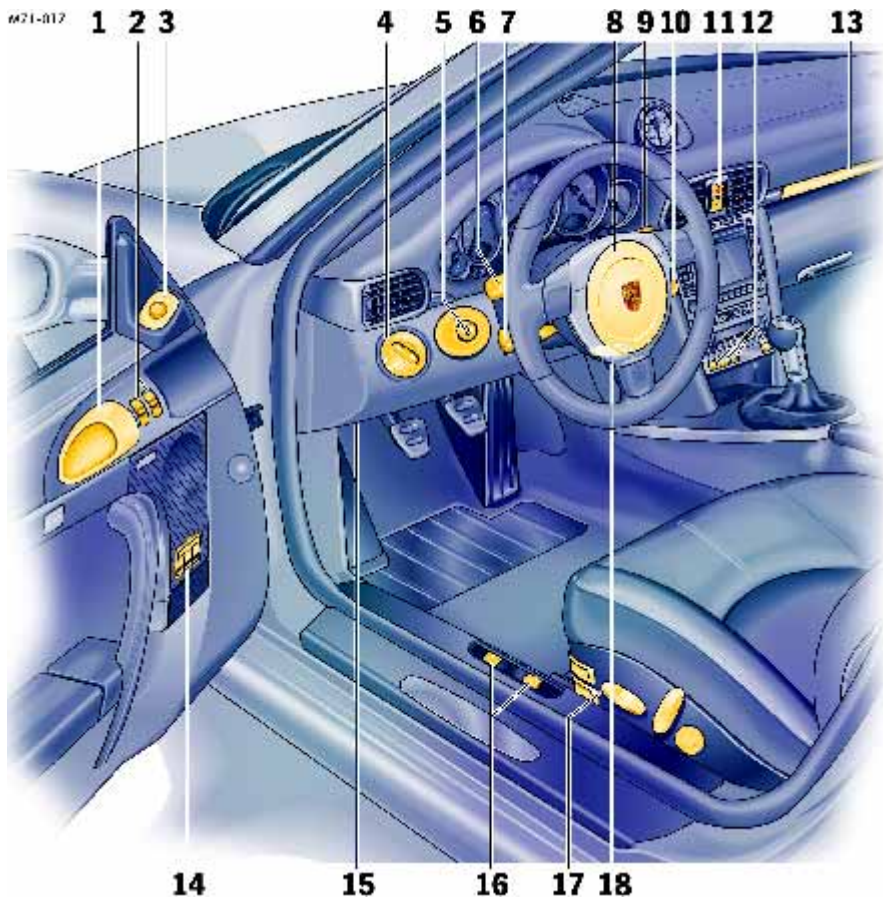

- 1 Door handle
- 2 Power windows
- 3 Door mirror adjuster
- 4 Light switch
- 5 Ignition lock/steering lock
- 6 Direction indicator/dipped beam and headlight flasher stalk
- 7 Operating lever for on-board computer
- 8 Horn
- 9 Operating lever for windscreen wiper
- 10 Operating lever for cruise control
- 11 Button for hazard warning lights, central locking system
- 12 Buttons for rear spoiler, Porsche Active Suspension Management (PASM), Sport mode, Porsche Stability Management (PSM)
- 13 Cupholder
- 14 Switch for seat memory
- 15 Diagnostic socket
- 16 Lid release
- 17 Seat adjustment
- 18 Steering wheel adjustment

Keys

You will be given two vehicle keys that let you operate all the locks on your vehicle.

- ▷ Be careful with your vehicle keys: do not part with them except under exceptional circumstances.
- ▷ Inform your insurance company of any loss or theft of car keys or if extra or replacement keys have been made.
- ▷ Remove the ignition key, even if leaving the vehicle only briefly.
Engage the steering lock correctly.

Emergency operation

- ▷ Please observe the chapter “EMERGENCY OPERATION – RELEASING THE IGNITION KEY” on page 61.

Replacement keys

Vehicle keys can only be ordered at a Porsche partner. Sometimes, this may take a long time. You should therefore always keep the spare key on your person. Keep it in a safe place, but under no circumstances in or on the vehicle.

The key codes of new keys have to be “taught” to the vehicle control unit by your Porsche partner.

Teach-in can be carried out for a total of 6 vehicle keys.

Disabling key codes

If keys are lost, the key codes can be disabled by a Porsche partner.

All the remaining car keys are required for this purpose.

Disabling the code ensures that the car can be started only using authorised keys.

Note

- ▷ Please note that the other locks can still be opened with the disabled key.

Immobiliser

There is a transponder (an electronic component) in the key grip, containing a stored code.

When the ignition is switched on, the ignition lock checks the code.

The immobiliser can be switched off and the engine started only using an authorised ignition key.

Switching off the immobiliser

- ▷ Insert the ignition key into the ignition lock.

If the ignition is left on for more than 2 minutes without the engine being started, the immobiliser is reactivated.

- ▷ If this happens, turn the ignition key back to the **3** position before starting the engine.

Switching on the immobiliser

- ▷ Remove ignition key.

Security wheel bolts

- ▷ If the wheels have to be removed at the workshop, please do not forget to hand over the socket for the security wheel bolts along with the vehicle key.

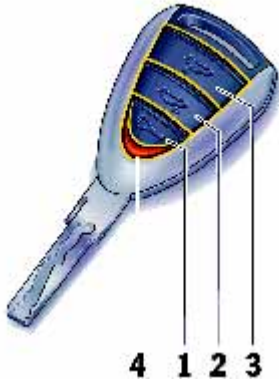

- 1 - Button for central locking
- 2 - Button for luggage compartment lid
- 3 - Button for the convertible top
- 4 Light-emitting diode

Key with Radio Remote Control

Unlocking the vehicle

- ▷ Press button **1** briefly.

Locking the vehicle

- ▷ Press button **1** briefly.

B11-002

Switching off the alarm system if it is triggered accidentally

- ▷ Unlock the vehicle.

Unlocking luggage compartment lid

- ▷ Press button **2** for approx. two seconds.

If the vehicle was locked, it is unlocked simultaneously with the luggage compartment. For vehicles with seat memory, the stored seat and door mirror positions are adjusted automatically.

The vehicle will be locked again approx. 15 seconds after the luggage compartment is closed if none of the doors was opened.

After relocking, the doors can be opened again with the inner door handle (theft protection is limited).

Note

It is possible to program further unlocking variants for the luggage compartment.

- ▷ Consult a qualified specialist workshop. We recommend a Porsche partner for this work as they have trained workshop personnel and the necessary parts and tools.

Option 1

The relocking time of the doors can be adjusted to suit your individual requirements: 10 - 100 seconds.

Option 2

The doors stay locked when the luggage compartment is unlocked.

Operating the convertible top

- ▷ Please observe the chapter "CONVERTIBLE TOP" on page 154.

The remote control standby function switches off after 7 days

If the vehicle is not started or unlocked with the remote control within seven days, the remote control standby function is switched off (to save the vehicle battery).

1. In this case, unlock the driver's door with the key at the door lock.
Leave the door closed in order to prevent the alarm system from being triggered.

2. Press button **1** on the remote control.

The remote control is now activated again.

Operational readiness of the remote control interrupted

Encoded data is transmitted to the vehicle each time the wireless remote control is operated. If the remote control is operated too often outside the range of the vehicle, this can result in the central locking system no longer responding. In this case, the remote control and vehicle must be synchronised.

Carrying out the synchronisation

1. Unlock the driver's door with the key at the door lock.
2. Open driver's door and insert the ignition key into the ignition lock within 10 seconds to prevent the alarm system from being triggered.
3. With the key inserted, press and hold button **1** on the remote control for approx. 5 seconds. The synchronisation is now complete.

Central Locking

- ▷ Please observe the chapter “SEAT MEMORY” on page 25.
- ▷ Please observe the chapter “LOAD SWITCH-OFF AFTER 2 HOURS OR 7 DAYS” on page 211.

Both car doors and the filler flap can be centrally unlocked or locked with the remote control.

The vehicle cannot be locked if the driver's door is not completely closed.

A short signal from the **alarm horn** will draw your attention to the fact that the following components are not completely closed when you lock the vehicle:

- Passenger's door
- Luggage compartment lid
- Engine compartment lid
- Glove compartment

Note on operation

Further unlocking variants are available in vehicles with the Sport Chrono Turbo package. Please observe the chapter “Individual Memory” in the separate PCM operating instructions.

Automatic relocking

If the car is unlocked by remote control and none of the car doors is opened within approximately 60 seconds, automatic relocking takes place. This relocking time can be adjusted to your individual requirements (10 - 100 seconds).

- ▷ Consult a qualified specialist workshop. We recommend a Porsche partner for this work as they have trained workshop personnel and the necessary parts and tools.

Note

The doors can be opened after automatic relocking by pulling the inner door handle twice (theft protection is limited).

The desired locking condition can be achieved by unlocking/locking again.

Locking conditions



If the vehicle is only locked **once**, passengers remaining inside the car cannot open the door in an emergency.

- ▷ Quickly press button **1** of the remote control **twice** so that the door can be opened with the inner door handle.
-

- ▷ Lock vehicle **once**.
The doors cannot be opened, either from outside or from inside.
The alarm system and passenger compartment monitoring system are switched on.
- ▷ Quickly press button **1** of the remote control **twice**.
The passenger compartment monitoring system is switched off.
The doors are locked but can be opened from the inside. **To do this:**
 1. Pull inner door handle once.
Door lock is unlocked.
 2. Pull inner door handle again.
Door can be opened.

Inform any persons remaining in the vehicle that the alarm system will be triggered if the door is opened.

Malfunction of the remote control

The remote control may not function correctly due to local radio waves. The vehicle will then not lock properly.

This can be identified by the missing locking sound and the missing check-back signal of the hazard warning lights.

Emergency operation – opening

- ▷ Unlock the driver's door with the key at the door lock.
Open door within 20 seconds and insert the ignition key into the ignition lock within 10 seconds to prevent the alarm system from being triggered.

Note on operation

If the door is not opened within approx. 20 seconds, automatic relocking takes place. The alarm system will be triggered by the next unlocking of the door:

- ▷ Insert the ignition key into the ignition lock to switch off the alarm system.

Emergency operation – closing

- ▷ Lock the driver's door with the key at the door lock.
If there is a defect in the central locking system, all functioning elements of the central locking system will be locked.
The alarm system is switched on; the passenger compartment monitoring system is switched off.
- ▷ Consult a qualified specialist workshop. We recommend a Porsche partner for this work as they have trained workshop personnel and the necessary parts and tools.

Indication by the hazard warning lights

If the remote control is used for unlocking or locking, a response is provided by the hazard warning lights:

- Unlocking – single flash
- Locking once – double flash
- Locking twice – continuous illumination for approx. 2 seconds

Fault indication

A double horn signal during locking indicates a fault in the central locking system or alarm system.

- ▷ Consult a qualified specialist workshop. We recommend a Porsche partner for this work as they have trained workshop personnel and the necessary parts and tools.



Locking

- ▷ Press the central locking button. When the ignition is switched on, the light-emitting diode in the button is lit. The doors can be opened by pulling the inner door handle twice.

Unlocking

- ▷ Press the central locking button. Light-emitting diode goes out.

Central locking button

The central locking button on the dashboard lets you lock and unlock both doors electrically. If the doors were locked with the key or by the remote control, they cannot be unlocked with the button.

Automatic door locking

Automatic door locking can be programmed in the control unit of the central locking system: Doors lock automatically when a speed of 5 - 10 km/h (3 - 6 mph) is exceeded.

- ▷ Consult a qualified specialist workshop. We recommend a Porsche partner for this work as they have trained workshop personnel and the necessary parts and tools.

On vehicles with the Sport Chrono Turbo package, the PCM can be used to activate automatic door locking.

Please observe the chapter "Individual Memory" in the separate PCM operating instructions.

Note

Automatically locked doors can be unlocked with the central locking button or opened by pulling on the inner door handle twice.

Overload protection

If the central locking system is operated more than ten times within a minute, further operation is blocked for 30 seconds.



Doors

Closed door windows will be automatically lowered by a few millimetres when the door is opened and raised again when the door is closed. This makes it easier to open and close the doors and protects the seals.

Therefore, you should pull the door handle slowly so that the door window can be lowered before the door is opened.

Opening doors from outside

- ▷ Unlock the doors with the remote control.
- ▷ Slowly pull door handle **A**.

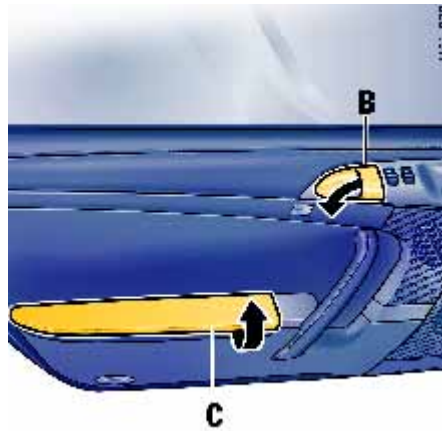

Opening unlocked doors from inside

- ▷ Slowly pull door handle **B**.

Opening locked doors from inside

- ▷ Pull door handle **B** twice.
- ▷ Please observe the chapter "LOCKING CONDITIONS" on page 13.

Door Oddments Tray

Opening the oddments tray

- ▷ Lift up cover **C**.

Always keep the door oddments tray **C** closed while driving for safety reasons.

Theft Protection

When leaving the vehicle, you should always:

- ▷ Close windows,
- ▷ Close sliding/lifting roof,
- ▷ Close the convertible top; the passenger compartment monitoring system is switched off when the convertible top is open (depending on the country equipment),
- ▷ Withdraw the ignition key,
- ▷ Lock the glove compartment,
- ▷ Remove valuables, car documents, telephone, and house keys from the car,
- ▷ Lock doors.



A - Light-emitting diode for alarm system

Alarm System, Passenger Compartment Monitoring System

The alarm system and passenger compartment monitoring system are switched on when the doors are locked with the key or by remote control.

- ▷ Please observe the chapter “CENTRAL LOCKING” on page 13.

In order not to limit the action range of the passenger compartment monitoring system:

- ▷ Do not fold the front seat backrests forward.

Switching off the alarm system if it is triggered accidentally

- ▷ Unlock the vehicle with the remote control.

The alarm system and passenger compartment monitoring system are switched off automatically when the doors are unlocked.

Cabriolet

The passenger compartment monitoring system is switched off when the convertible top is open (depending on the country equipment).

Function indication

If the alarm system is activated, light-emitting diode **A** in the central locking button flashes.

If, after locking, the light-emitting diode does not flash or emits double flashes after 10 seconds, this means that not all the alarm contacts are closed.

Additionally, a brief horn signal sounds and the interior light comes on for approx. 2 seconds.

The light-emitting diode goes out when the doors are unlocked.

The following areas are monitored

- Doors
- Luggage compartment lid and engine compartment lid
- Convertible top lock (Cabriolet)

- Glove compartment
- Passenger compartment

If one of these alarm contacts is interrupted, the alarm horn sounds for approx. 30 seconds. Additionally, the interior light lights up and the hazard warning lights flash for approx. 5 minutes. When the alarm is triggered, the light-emitting diode changes over to double flashes.

Temporarily deactivating the passenger compartment monitoring system

If persons or animals stay in the vehicle while it is locked, the passenger compartment monitoring system must be switched off:

- ▷ Quickly press button **1** of the remote control **twice**.
The doors are locked but can be **opened from the inside**. To do this:
 1. Pull door handle once.
Door lock is unlocked.
 2. Pull door handle again.
Door can be opened.
- ▷ Inform any persons remaining in the vehicle that the alarm system will be triggered if the door is opened.

Fault indication

A **double horn signal** during locking indicates that there is a fault in the alarm system or central locking system.

- ▷ Consult a qualified specialist workshop. We recommend a Porsche partner for this work as they have trained workshop personnel and the necessary parts and tools.

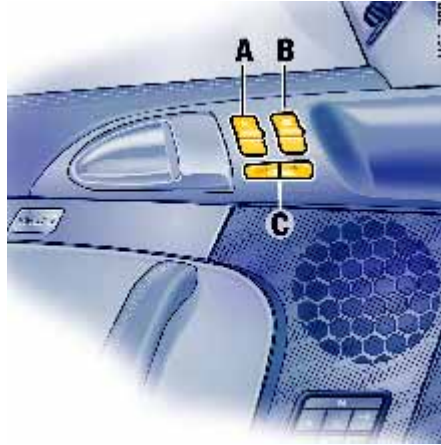

A - Power window in driver's door
B - Power window in passenger's door
C - Cabriolet: Switching button for power windows at front/rear

Power Windows



Warning!

Danger of injury when closing the windows, especially when windows close automatically.

- ▷ Take care to ensure that nobody can be injured when the windows close.
- ▷ Always withdraw the ignition key when leaving the vehicle.

Uninformed persons could injure themselves by operating the power windows.

- ▷ Do not leave children in the vehicle unattended.

Readiness for operation of power windows

- With the ignition switched on (engine on or off) **or**
- With door closed and ignition key withdrawn, but only until door is first opened. One-touch operation for closing the door windows is available only when the ignition is switched on.

Note for Cabriolet

When the convertible top is open, the rear side windows can only be closed if the door windows are closed.

Opening/closing windows

- ▷ For the **Cabriolet**, select front or rear power windows with rocker switch **C**. The selection is displayed by the respective light-emitting diode.

The two rocker switches **A** and **B** in the driver's door and the switch in the passenger's door have a two-stage function:

Opening window with the rocker switch

- ▷ Press the rocker switch down to the first stage until the window has reached the desired position.

Closing window with the rocker switch

- ▷ Press the rocker switch upwards to the first stage until the window has reached the desired position.



Risk of injury. If the rocker switch is pressed again within 10 seconds of the window being blocked, the window will close with its full closing force.

- ▷ Take care to ensure that nobody can be injured when the windows close.

Note on operation

If a window is blocked during closing, it will stop and open again by several centimetres. This does not apply if the rocker switch is pressed again within 10 seconds of the window being blocked again. The windows close with their full closing force.

One-touch operation is disabled for 10 seconds after the door window is obstructed.

One-touch operation

- ▷ Press the rocker switch upwards or downwards to the second stage. Window moves to its final position. Press again to stop the window in the desired position.

Note for Coupé

One-touch operation for closing the passenger's window is available once the window is approximately half-way closed.

Note for Cabriolet

The rear side windows can be opened using one-touch operation.

Coupé

Opening windows using car key in lock

1. Open doors with the remote control
2. Insert car key into door lock, turn to unlock position and hold in this position until the windows have reached the desired position.

Coupé

Opening windows using remote control

This function has to be activated to enable the windows to be opened using the remote control.

- ▷ Consult a qualified specialist workshop. We recommend that you use a Porsche partner for this work since these are staffed with trained personnel and have the necessary tools.

Automatic window lowering

- ▷ Please observe the chapter "DOORS" on page 16.
- ▷ Please observe the chapter "CONVERTIBLE TOP" on page 154.

Storing final position of the windows

If the battery is disconnected and re-connected, the windows will not be raised automatically when the door is closed.

1. Close windows **once** with the rocker switch.
2. Press rocker switch upwards again to store the final position of the windows in the control unit.



Door Mirrors

Function

The convex mirror on the passenger's side and the aspherical mirror on the driver's side provide a larger field of view.

Hb | 04C

Warning!

Risk of accident. Vehicles or objects appear smaller in convex mirrors and further away than they are in reality.

- ▷ Bear this distortion in mind when estimating the distance of vehicles behind you and when reversing into a parking space.
- ▷ Also make use of the interior mirror for judging distance.

Adjusting mirrors

1. Switch on ignition.
2. By turning the control switch **A**, select the driver's side or the passenger's side.
3. Move the door mirror glasses in the appropriate direction by tilting the control switch.

If the electrical adjustment facility fails

- ▷ Adjust the mirror by pressing on the mirror face.

Automatically swivelling down mirror on the passenger's side

- ▷ Please observe the chapter "PARKING AIDS" on page 54.
- ▷ Please observe the chapter "SEAT MEMORY" on page 25.

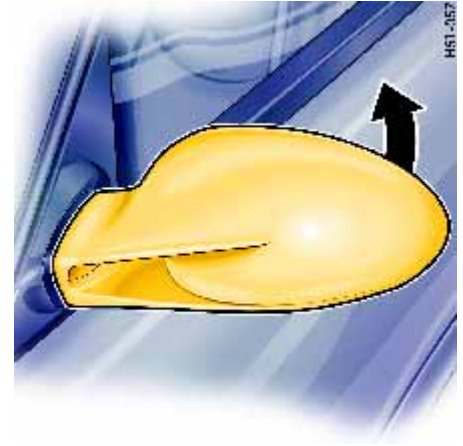

Folding in door mirrors

Warning!

Danger of injury to fingers if the mirror accidentally flips back when being folded in.

- ▷ Exercise extreme caution when folding in mirror by hand. Do not let go of the mirror before the locking lever is locked or the mirror is fully unfolded.

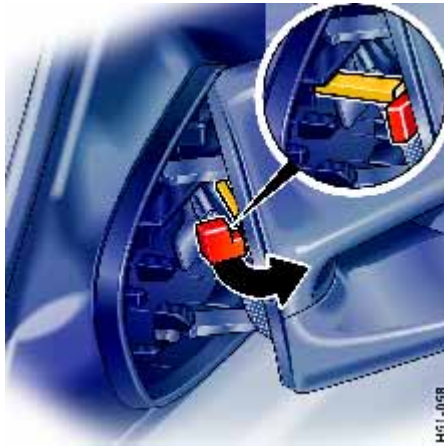

1. Push mirror towards the door window and continue to hold it (high spring force).
2. Swivel the locking lever up to the stop and slowly let go of the mirror.

Unfolding door mirrors

1. Push mirror towards the door window and continue to hold it (high spring force). The locking lever disengages automatically.
2. Move mirror back to unfolded position by hand. Do not let go of the mirror beforehand.

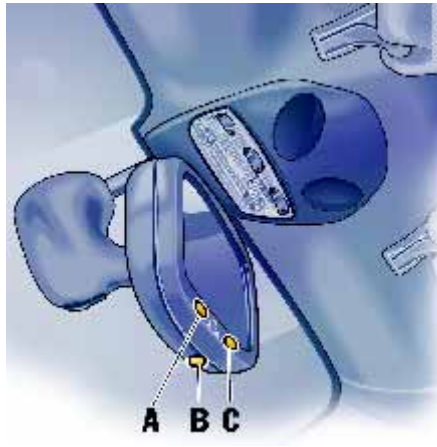

- A** - Sensor
B - Switch for automatic anti-dazzle function
C - Light-emitting diode

Automatic Anti-Dazzle Interior and Door Mirrors

Function

Sensors on the front and rear sides of the interior mirror measure the incident light. The mirrors automatically change to anti-dazzle position or revert to their normal state, depending on the light intensity. When reverse gear is selected, automatic anti-dazzle operation is switched off.

Note

The incident light in the area of the sensors must not be obstructed, e.g. by stickers on the windscreen.

Switching off automatic anti-dazzle operation

- ▷ Press switch **B**.
Light-emitting diode **C** goes out.

Switching on automatic anti-dazzle operation

- ▷ Press switch **B**.
Light-emitting diode **C** goes out.

Warning!

Risk of injury. Electrolyte fluid can emerge from broken mirror glass. This fluid irritates the skin and eyes.

- ▷ If the electrolyte fluid should come into contact with the eyes or skin, immediately rinse it off with clean water.
See a doctor if necessary.

Risk of damage to paintwork and leather and plastic parts. Electrolyte fluid can be removed only while it is still wet.

- ▷ Clean the affected parts with water.



Door Mirror Heating/ Heated Rear Window

Door mirror heating/heated rear window is ready for operation when the ignition is on.

Switching on

- ▷ Press button.
The light-emitting diode in the button lights up.

After approx. 15 minutes, the heater switches off automatically.

The heating can be switched back on again by pressing the switch again.

Switching off

- ▷ Press button.
The light-emitting diode in the button goes out.

Seat adjustment



Warning!

Risk of accident. The seat may move further than desired if you attempt to adjust it whilst driving.

You can lose control of the vehicle.

- ▷ Do not adjust the seat whilst driving.

Risk of damage. In the Cabriolet, the windstop may be damaged when adjusting the seat and folding back the front seat backrests.

- ▷ Adjust the seat so that the seat backrest does not touch the windstop.

Seat position

An ergonomically correct sitting position is important for safe and fatigue-free driving.

We recommend the following procedure for adjusting the driver's seat to suit individual requirements:

1. Vehicles with manual transmission:
Adjust the seat until, with the clutch pedal fully depressed, your leg remains at a slight angle.

Vehicles with Tiptronic S:

Adjust the seat until, with your left foot on the footrest, your left leg remains at a slight angle.

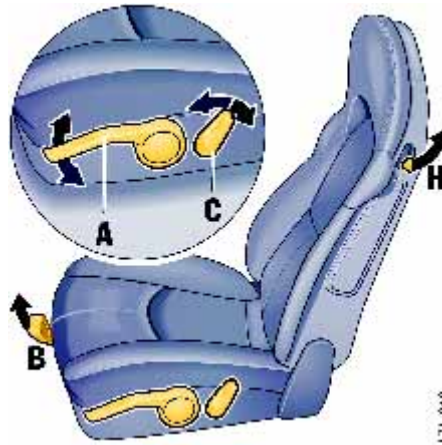

L71-0060

Manually adjustable sports seat

A Seat height

- ▷ Use lever **A** in a pumping movement:
Upwards – seat moves upwards
Downwards – seat moves downwards

B Fore and aft

- ▷ Raise locking lever **B**.
Move seat to desired position and release lever.
Ensure that the seat engages correctly.

C Backrest angle

- ▷ Operate switch **C** until the desired backrest angle is reached.

2. Rest your outstretched arm on the steering wheel.
Set the backrest angle and the steering-wheel position so that your wrist rests on the outer rim of the steering wheel. At the same time, the shoulders must still be in noticeable contact with the backrest.
3. Adjust the seat height to give yourself enough headroom and a good overview of the vehicle.
4. Electrically adjustable seat:
Adjust the seat angle until your thighs rest lightly on the seat cushion.

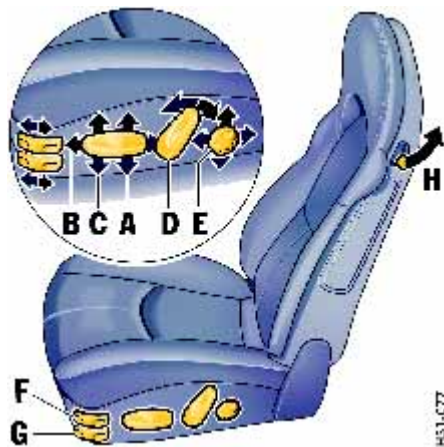

Electrically adjustable comfort seat/sports seat

- ▷ Press the switch in the direction indicated by the arrow until the desired setting is reached.

- A Seat height adjustment**
- B Fore-and-aft position adjustment**
- C Seat angle adjustment**
- D Backrest angle adjustment**

E Lumbar support (pelvis and spinal column support)

To permit a relaxed sitting posture, the backrest curvature is continuously adjustable in vertical and horizontal directions for individual pelvis and spinal column support.

- ▷ Press the switch in the direction indicated by the arrow until the desired backrest curvature is reached.

F Adjusting the backrest side bolsters (electrically adjustable sports seats only)

- ▷ Push forward or pull backward switch **F** until the side bolsters are adjusted to the shape of the body.

G Adjusting the seat cushion side bolsters (electrically adjustable sports seats only)

- ▷ Push forward or pull backward switch **G** until the side bolsters are adjusted to the shape of the body.

Seat backrest

Folding forward

- ▷ Pull up lever **H** in the side part of the backrest and fold the backrest forward.

Folding back

- ▷ Tilt back and engage the backrest so that it cannot tip forward when the car is braked.



M - Memory button
1 - Key button
2, 3 - Person buttons

Seat memory

Individual seat and door mirror settings can be stored and recalled for the driver's position.

Further individual setting options are available in vehicles with the Sport Chrono package. Please observe the chapter "Individual Memory" in the separate PCM operating instructions.

Warning!

Risk of crushing due to uncontrolled recall of a seat setting.

- ▷ Cancel automatic adjustment by pressing any of the seat adjustment buttons.
- ▷ Do not leave children in the vehicle unattended.

Operation with person buttons 2, 3

Storing seat position

1. Switch on ignition.
Reverse gear must not be engaged.
2. Set the desired seat and door mirror positions.
3. Keep memory button **M** depressed and additionally press person button **2 or 3**.
The individual setting is now stored under the desired person button.

Recalling seat position

The seat position can only be called up when the vehicle is at a standstill.

1. Switch on the ignition **or** open the driver's door.
2. Press person button until the seat has reached its final position.
The door mirror and the lumbar support settings will be completed even if the person button is not kept depressed.

Note

Automatic seat adjustment can be interrupted immediately by releasing the button.

Operating with the remote control of the vehicle key

Each remote control (up to six) can be assigned an individual seat and door mirror position. The stored seat and door mirror position is set automatically when the vehicle is unlocked using the corresponding remote control.

Storing seat position

1. Switch the ignition on with the desired vehicle key.
Reverse gear must not be engaged.
2. Set the desired seat and door mirror positions.
3. Keep memory button **M** depressed and additionally press key button **1**.
The individual setting is now assigned to this remote control and to the key button.

Storing individual lowered position of the passenger's door mirror as a parking aid

Once the driver's seat setting has been stored, an individual lowered position of the passenger's door mirror may be stored for driving in reverse:

1. Apply the handbrake.
2. Switch the ignition on with the desired vehicle key.
3. Engage reverse gear.
4. Select passenger side with mirror switch.
The passenger's door mirror swivels downwards.
5. Set passenger's door mirror to desired final position.
6. Keep memory button **M** depressed and additionally press key button **1**.
The individual setting is now assigned to this remote control and to the key button.

Recalling seat position

- ▷ Unlock the locked vehicle or the luggage compartment with the remote control.
The stored seat position is automatically set.

The seat position assigned to a remote control can also be recalled with the key button **1** if the corresponding key was used to switch on the ignition.

If no seat position has been assigned to a remote control, the key button will not work.

Note on operation

Automatic seat adjustment can be interrupted immediately:

- by switching on the ignition,
- by pressing the central locking button,
- by pressing any memory or seat adjustment button.

Clearing the stored seat position

1. Switch the ignition on with the desired vehicle key.
2. Press memory button twice and key button **1** once consecutively.



A - Seat heating, left
B - Seat heating, right

Seat Heating

Two-stage seat heating is ready for operation when the ignition is on.

Switching on

High heating power

- ▷ Press button.
Both light-emitting diodes in the button light up.

Low heating power

- ▷ Press the rocker-switch symbol again.
One light-emitting diode in the button lights up.

Switching off

- ▷ Press button.
Light-emitting diodes go out.



Rear Seat Backrests

Extra storage space is gained by folding the rear seat backrests forward.

Folding forward

- ▷ Pull lever forward and fold the backrest forward.

Folding back

- ▷ Tilt the backrest back until you feel it click into place. When doing so, make sure that the seat belt is properly routed (**Figure**).

Cabriolet

- ▷ Do not fold up the rear seat backrests with the windstop installed.

Steering Wheel Adjustment

Warning!

Risk of accident. The steering wheel may move further than desired if you attempt to adjust it whilst driving. You can lose control of the vehicle.

- ▷ Do not adjust the steering wheel whilst driving.



Adjusting steering wheel height and longitudinal direction

1. Insert ignition key fully into ignition lock.
2. Push locking lever downwards.
3. Adjust steering wheel to suit the chosen backrest angle and your seat position by moving the steering wheel up or down and longitudinally.
4. Swivel locking lever back until you feel it engage.
If necessary, move steering wheel slightly longitudinally.

Multi-Functional Steering Wheel



Warning!

Operating the on-board computer, the radio, the navigation system, the telephone or other equipment while driving is dangerous and can result in an accident.

This could distract you from the traffic and cause you to lose control of the vehicle.

- ▷ Operate these components while driving only if the traffic situation allows you to do so safely.
- ▷ Carry out any complicated operating or setting procedures only while the vehicle is stationary.

Depending on the equipment in your vehicle, you can use the function keys of the multi-functional steering wheel to operate the following Porsche communication systems:

- PCM,
- Telephone,
- CD changer.



Readiness of the multi-functional steering wheel for operation

The multi-functional steering wheel is ready for operation when the ignition **and** PCM are switched on.

Operating the function keys

- ▷ Please read the separate PCM operating instructions before operating the function keys.

The rotary knobs at the top left and right of the steering wheel can also be pressed.



Turn volume control

Upwards - increase volume
Downwards - decrease volume

Press volume control

To switch volume/mute on and off.



Turn rotary knob

To select/mark function in the PCM within a menu. To do this, turn the rotary knob upward or downward.

Press rotary knob

To activate selected function.



Press screen button

To call the stored PCM function. The button can be assigned the desired function in the PCM.



Press Back button

To move back in the PCM menu.



Press Handset Pickup button

To accept a telephone call.



Press Handset Hangup button

To end or refuse a telephone call.

Sun visors

- ▷ Swing the sun visors down to prevent dazzle from the front.
- ▷ If you are dazzled from the side, unclip the sun visor from the inner bracket and swivel it round so that it is in front of the door window.

Make-up mirror

The make-up mirror on the rear of the sun visor is closed with a cover.



Risk of injury.

- ▷ Keep the cover closed while driving and when closing the convertible top.

Risk of damage.

- ▷ Do not force the cover beyond its end position.



The make-up mirror illumination is switched on automatically when the cover is opened (arrow).

Seat Belts

The front seat belts are not suitable for persons under approx. 150 cm (5 ft.) tall. Suitable restraint devices should therefore be used.

Safety notes!

- ▷ All occupants of the vehicle must wear seat belts for their own safety, on every journey. Give your passengers all the information in this chapter.
- ▷ Never use **one** belt for two persons at the same time.
- ▷ Remove any loose, bulky items of clothing that prevent the belt from fitting correctly and restrict your freedom of movement.
- ▷ Do not lay the diagonal part of the belt across hard or breakable objects (spectacles, ball-point pens, pipes, etc.). Such articles may represent an additional danger of injury.
- ▷ Belt straps must not be twisted or loose.
- ▷ Check all belts regularly for signs of damage in the fabric, and check that the buckle and attachment points function correctly.

- ▷ Belts that are damaged or have been heavily stressed in an accident must be replaced immediately. The same applies to belt tensioner systems which have been triggered. In addition, the anchor points of the belts should be checked. Consult a qualified specialist workshop. We recommend a Porsche partner for this work as they have trained workshop personnel and the necessary parts and tools.
- ▷ Make sure the belts are fully retracted when they are not being used. This protects them from dirt and damage.



Warning light and warning message

The following functions serve as a reminder to fasten the seat belts:

- The warning light on the instrument panel lights up when the ignition is switched on.
- A warning is displayed on the on-board computer.
- A warning signal (gong) sounds when the speed exceeds 24 km/h (15 mph) for approx. 90 seconds.

These functions remain active until the tongue of the driver's seat belt has been inserted into the buckle.

Belt tensioner

Depending on the force of a collision, fastened seat belts of the front seats are tightened in an accident.

The belt tensioners are triggered by:

- Front, side and rear impacts
- For the Cabriolet, the vehicle overturning

Note

The belt tensioner system can be triggered only once; the system must be replaced afterwards.

If there is a fault in the belt tensioner system, the airbag warning light lights up.

Work may only be carried out on the belt tensioner system by a qualified specialist workshop. We recommend a Porsche partner for this work as they have trained workshop personnel and the necessary parts and tools.

Smoke is released when the belt tensioners are triggered. This does not indicate a fire in the vehicle.



Fastening the seat belt

- ▷ Assume a comfortable sitting position. Please observe the chapter "SEAT POSITION" on page 23.
- ▷ Adjust the seat backrest so that the belt always rests on your upper body and runs across the middle of your shoulder.
- ▷ Grasp the belt tongue and pull the belt in a slow, continuous motion across your chest and lap. The belt cannot be pulled out while accelerating and slowing down, when cornering and when driving uphill.

Note on operation

The belt can be blocked if the vehicle is standing at an angle or if the belt is pulled out using a jerking movement.

- ▷ Insert the belt tongue into the appropriate buckle on the inboard side of the seat, until it locks securely with an audible click.
- ▷ Make sure that belts are not trapped or twisted, and that they are not rubbing on sharp edges.
- ▷ The horizontal section of the belt should always fit snugly across the pelvis. Therefore, after fastening the belt, always pull the diagonal part of the belt upwards. Pregnant women should position the belt as low as possible across the pelvis, and ensure that it is not pressing against the abdomen.
- ▷ Pull on the diagonal section of the belt now and again during the journey to ensure that the horizontal section remains tight.

Releasing the seat belt

- ▷ Hold the belt tongue.
- ▷ Press the red button (**arrow**).
- ▷ Guide belt tongue to the reel.



Seat belt height adjustment (Coupé)

Adjust the height of the seat belt so that it runs across the middle of the shoulder, not against the neck.

Adjusting belt height

- ▷ Upward – push belt deflector up.
- ▷ Downward – press button (**arrow**) and move belt deflector.

Cleaning the seat belts

- ▷ Please observe the chapter "SEAT BELTS" on page 196.

Child Restraint System



Danger!

Risk of serious or mortal injury from passenger airbag if not switched off when using a child restraint system.

- ▷ If children weighing up to 27 kg are going to be transported in a child restraint system on the passenger's seat, the passenger airbag must be switched off.
If the body weight is more than 27 kg, the passenger airbag should be switched on.
 - ▷ Seek appropriate advice from your Porsche partner about the possible installation of a Porsche child restraint system.
-

Note

The key switch for switching off the passenger airbag and the Isofix attachment bracket are not installed at the factory. They can be retrofitted.

- ▷ Consult a qualified specialist workshop. We recommend a Porsche partner for this work as they have trained workshop personnel and the necessary parts and tools.

Safety notes!

- ▷ Always observe the separate installation instructions for your child seat.
 - ▷ When using a child restraint system, it is vital that you observe the legal regulations applicable in your country.
 - ▷ Use only child restraint systems recommended by Porsche.
These systems have been tested and adjusted to the interior of your Porsche and the appropriate child age groups.
Other systems have not been tested and could entail an increased risk of injury.
 - ▷ If possible, always fit child seats for the age groups from 9 months to 12 years on the rear seats.
Fit child seats for the age group up to 9 months exclusively on the passenger's seat.
-
- ▷ Please observe the chapter "SWITCHING PASSENGER AIRBAG ON AND OFF" on page 36.

Children up to 9 months old

Children of this age must be held in a restraint system which is installed on the passenger's seat **facing backwards**.

- ▷ The passenger airbag must be switched off.

Children aged between 9 months and 3 years

Children of this age are carried in child restraint systems **facing forward**.
Whenever possible, these child restraint systems should be installed on the rear seats.

- ▷ The passenger airbag must be switched off when these systems are used on the passenger's seat.

Children aged between 3 and 6 years

Children of this age are carried in child restraint systems **facing forward**.
Whenever possible, these child restraint systems should be installed on the rear seats.

- ▷ The passenger airbag must be switched off when these systems are used on the passenger's seat.

Children aged between 6 and 12 years

Children of this age are carried in child restraint systems **facing forward**.
Whenever possible, these child restraint systems should be installed on the rear seats.

- ▷ The passenger airbag must be switched off when these systems are used on the passenger's seat.
For children weighing 27 kg or more, the passenger airbag should be switched on.

Recommended child restraint systems

Age group	Weight group	Seat type	Authorisation number	Allowed on passenger's seat	Allowed on rear seat
up to approx. 9 months	up to 13 kg	Porsche Baby seat 0+ Isofix Universal Porsche Baby Seat 0+ Isofix Special Porsche part No.: 955.044.800.42	E13 030011 E13 030012	yes	no
between 9 months and 3 years	between 9 kg and 18 kg	JUNIOR SEAT ISOFIX Group I Universal Junior Seat Isofix Group I Special Porsche part No.: 955.044.800.44	E13 030013 E13 030014	yes	yes
between 3 and 6 years	between 16 kg and 25 kg	JUNIOR SEAT ISOFIX Group II Universal Porsche part No.: 955.044.800.44	E13 030015	yes	yes
between 6 and 12 years	between 15 kg and 36 kg	Porsche KID Plus Porsche part No.: 955.044.801.02	E1 03301169	yes	yes

Note

If children weighing up to 27 kg are to be transported in a child restraint system on the passenger's seat, the passenger airbag must be switched off.

If the body weight is more than 27 kg, the passenger airbag should be switched on.



Switching passenger airbag on and off

- ▷ Switch off the passenger airbag on the key switch using the vehicle key.

A - Switch position ON – airbag is active

B - Switch position OFF – airbag is not active

Danger!

Risk of serious or mortal injury for passenger if passenger airbag remains switched off after the child seat is removed.

- ▷ The passenger airbag must be switched on again once the child seat has been removed.



Warning light “PASSENGER AIRBAG OFF”

If the airbag is switched off on the passenger's side, the “PASSENGER AIRBAG OFF” warning light is continuously lit when the ignition is switched on.

Danger!

Risk of serious or mortal injury from the passenger's airbag.
If the “PASSENGER AIRBAG OFF” warning light is not lit when the ignition is switched on and the Airbag OFF switch is switched off, this could indicate a fault in the system.

- ▷ Do not install a child restraint system on the passenger's seat.
- ▷ Have the fault remedied immediately. Consult a qualified specialist workshop. We recommend a Porsche partner for this work as they have trained workshop personnel and the necessary parts and tools.

Note

The key switch and the warning light “PASSENGER AIRBAG OFF” are not installed at the factory. They can be retrofitted by your dealership.

ISOFIX system

Child seat bracket on the passenger's seat

Use only child restraint systems with the ISOFIX system recommended by Porsche. These systems have been tested and adjusted to the interior of your Porsche and the appropriate child age groups.

Other systems have not been tested and could entail an increased risk of injury.

You can obtain ISOFIX-compatible child seats from your Porsche partner.

- ▷ Always observe the separate installation instructions for your child seat.

Note

The ISOFIX attachment bracket is not installed at the factory. It can be retrofitted at your dealership.



Danger!

Risk of serious or mortal injury from passenger airbag if not switched off when using a child restraint system.

- ▷ The passenger airbag must always be switched off if child restraint systems are installed on the passenger's seat for children weighing up to 27 kg. For children weighing 27 kg or more, the passenger airbag should be switched on.
- ▷ Please observe the chapter "CHILD RESTRAINT SYSTEM" on page 33.

Installing a child seat with ISOFIX system

1. Switch off passenger airbag with key switch. The warning light "PASSENGER AIRBAG OFF" must be lit up. Please observe the chapter "SWITCHING PASSENGER AIRBAG ON AND OFF" on page 36.
2. Secure the child seat to retaining lugs **A** as outlined in the instruction manual for the child seat.
3. Pull the child seat to check that both fastening points are engaged correctly.

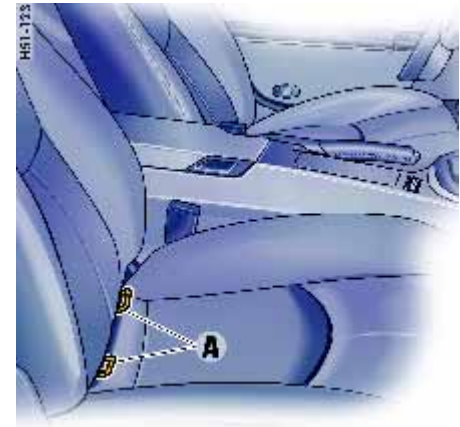

Note

The airbag must be switched back on after removing the child seat.

Airbag Systems

General information



Danger!

- ▷ **Always fasten seat belts**, because triggering of the airbag system depends on the force and angle of impact.
- ▷ Make sure there are no persons, animals or objects between the driver or passenger and the area into which the airbag inflates.
- ▷ Always hold the steering wheel by the outer rim.
- ▷ For airbags to give effective protection, they must be a certain distance from the driver or passenger.
So select your seat position so that it is not unnecessarily close to the airbags.
Do not lean against the inside of the doors (side airbags, head airbags).
- ▷ Always leave feet in the footwell when driving. Do not put feet on the dashboard or the seat cushion.
- ▷ Always keep the lid of the door oddments tray closed. Objects must not protrude out of the door oddments tray.
- ▷ Do not transport heavy objects on or in front of the passenger seat.
- ▷ Give your passenger all the information in this chapter.

- ▷ Always consult a qualified specialist workshop if the airbag system is faulty.
- ▷ Airbag systems which have been triggered must be checked or replaced without delay.
- ▷ Do not modify the wiring or components of the airbag systems.
- ▷ Do not attach any additional trim or stickers to the steering wheel or in the vicinity of the passenger airbag, side airbags or head airbag.
- ▷ Do not route any cables of additional electrical equipment in the vicinity of the airbag wiring harnesses.
- ▷ Do not remove airbag components such as the steering wheel, door linings or seats.
- ▷ If you sell your Porsche, tell the buyer that the car is fitted with airbags and refer him to the chapter "Airbag Systems" in the Driver's Manual.
- ▷ Have the operational readiness of the airbag system checked at the specified maintenance intervals.
- ▷ Please observe the chapter "CHILD RESTRAINT SYSTEM" on page 33.

Function

In conjunction with the seat belts, the airbags are a safety system designed to provide the driver and passenger with maximum protection from injury in an accident.

Airbags protect the head and upper body, whilst simultaneously damping the motion of the driver and passenger in the impact direction in the event of a frontal impact or side impact.

The **front airbags** are installed under the padded steering wheel panel on the driver's side and in the dashboard on the passenger's side.

The **side airbags** are installed in the side of the seat backrests.

The **head airbags** are installed in the door lining.

The respective airbags could trigger depending on the angle of impact and force of impact.

After inflation, the front airbags deflate so quickly that any restriction of vision is insignificant. Equally, the inflating noise will be drowned out by the noise of the accident.



Warning light and warning message

Faults are indicated by the warning lights on the instrument panel and on the on-board computer.

- ▷ Please observe the chapter “WARNINGS ON THE INSTRUMENT PANEL AND THE ON-BOARD COMPUTER” on page 106.
- ▷ Please consult a qualified specialist workshop in the following cases:
 - If the warning light does not light up when the ignition key is inserted **or**
 - If the warning light does not go out once the engine is running **or**
 - If the warning light appears whilst driving.

1121-124



Warning light “PASSENGER AIRBAG OFF”

- ▷ Please observe the chapter “SWITCHING PASSENGER AIRBAG ON AND OFF” on page 36.

Danger!

Risk of serious or mortal injury from the passenger’s airbag.
If the “PASSENGER AIRBAG OFF” warning light is not lit when the ignition is switched on and the Airbag OFF switch is switched off, this could indicate a fault in the system.

- ▷ If the warning light does not appear, the child restraint system must not be used.
- ▷ Have the fault remedied immediately.

Risk of serious or mortal injury for passenger if passenger airbag remains switched off after the child seat is removed.

- ▷ The passenger airbag must be switched on again once the child seat has been removed.

Disposal

Non-ignited gas generators, or whole vehicles or subassemblies with airbag units, must not be disposed of as “normal” scrap or waste or put into any other form of end storage.

Your Porsche partner will be able to give you details about disposal.

Roll-Over Protection

With the Cabriolet, a roll-over protection system installed behind the rear seats is extended within fractions of a second in the event of accidents or extreme driving situations. If necessary, the seat-belt tensioners will be activated.

- ▷ Please observe the chapter “BELT TENSIONER” on page 31.

Extreme driving situations include

- Extreme tilting or leaning (vehicle threatening to roll over to the side, or to roll over in the fore and aft direction),
- The vehicle lifting from the road (e.g. by jumping over a hump).

The roll-over protection system consists of two roll-over bars that, together with the windscreen frame, ensure sufficient headroom for all occupants if the vehicle should roll over.

Caution!

Risk of damage to the convertible top and roll-over bars.

- ▷ Do not open or close the convertible top with the roll-over bars extended.

Safety notes!

- ▷ Always keep space clear for the roll-over bars to move.
- ▷ No modifications should be made to the wiring or components of the roll-over protection system.
- ▷ If the roll-over protection system is in any way faulty, consult a qualified specialist workshop. We recommend a Porsche partner for this work as they have trained workshop personnel and the necessary parts and tools.
- ▷ Have the operational readiness of the airbag system checked at the specified maintenance intervals.



Warning message

If a fault is present in the roll-over bar system, a message appears on the on-board computer. Extension of the roll-over bars is no longer ensured.

- ▷ Have the fault repaired without delay. Consult a qualified specialist workshop.

Pushing back the extended roll-over bars

- ▷ Consult a qualified specialist workshop. We recommend a Porsche partner for this work as they have trained workshop personnel and the necessary parts and tools.

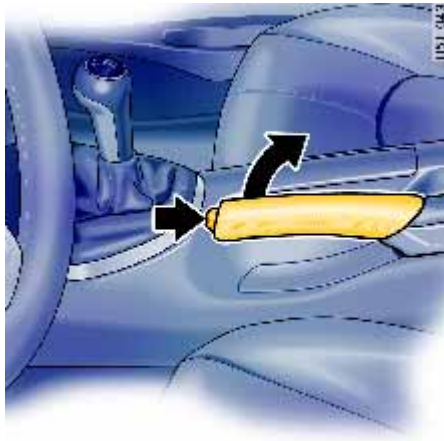

Applying the handbrake

- ▷ Pull handbrake lever upwards.

Releasing the handbrake

- ▷ Pull handbrake lever slightly upwards, press the locking button and lower the lever completely.

Warning light

The warning lights on the instrument panel and on the on-board computer are lit when the handbrake is on and go out when the handbrake is fully released.

- ▷ Please observe the chapter “WARNINGS ON THE INSTRUMENT PANEL AND THE ON-BOARD COMPUTER” on page 106.

Handbrake

The handbrake acts on the rear wheels and serves to secure the car from rolling away while parked.

Footbrake



Safety notes!

- ▷ Do not obstruct the pedal travel with floor mats or other objects.

The brake booster is ready for operation only while the engine is running. If the engine is switched off or there is a defect in the brake booster, much greater force has to be applied to the pedal when braking. The ABS and PSM do not operate if this is the case.

- ▷ Please observe the chapter “TOWING AND TOW-STARTING” on page 231.

In heavy rain, while driving through water or after leaving a car wash, the braking action may be delayed and increased pressure may be required.

- ▷ For this reason, keep further back from the vehicle in front and “dry” the brakes by applying them at short intervals. Make sure that following traffic is not affected.

After a long drive over salted or gritted roads, a coating may form on the brake discs and pads that significantly reduces friction and therefore also braking effect.

- ▷ Therefore, clean the brake discs and pads approx. every 2 weeks with a strong jet of water. The cleaning effect of automatic car washes is insufficient.
To prevent corrosion of the brake discs, “brake them dry” before parking the car (not on cars with Porsche Ceramic Composite Brake).
- ▷ Even though the brake discs consist of alloyed grey cast iron, they will unavoidably start to corrode if your car is parked for an extended period. The brakes will tend to “rub” as a result.
The nature, extent and effects of corrosion depend on the amount of time the vehicle was parked, whether road salt or grit was spread and whether grease-dissolving agents were used in car washes (not on cars with Porsche Ceramic Composite Brake).
If the braking comfort is noticeably impaired, we recommend having the brake system checked by experts. Consult a qualified specialist workshop. We recommend a Porsche partner for this work as they have trained workshop personnel and the necessary parts and tools.

- ▷ To relieve the braking system on downhill stretches, change down to a lower gear in good time to obtain engine braking. If engine braking is insufficient on steep stretches, operate the footbrake at intervals. Continuous braking overheats the brakes and reduces the braking effect.
 - ▷ Please observe the chapter “BRAKE FLUID LEVEL” on page 180.
-

Brake pads and brake discs

Wear on the brake pads and brake discs depends to a great extent on the driving style and the conditions of use and therefore cannot be expressed in actual miles on the road.

The high-performance brake system is designed for optimal braking effect at all speeds and temperatures.

Certain speeds, braking forces and ambient conditions (such as temperature and humidity) may therefore cause the brakes to squeal.

Warning light

When the wear limit for the pads has been reached, the warning lights on the instrument panel and on the on-board computer will light up.

- ▷ Please observe the chapter “WARNINGS ON THE INSTRUMENT PANEL AND THE ON-BOARD COMPUTER” on page 106.
- ▷ Have the brake pads replaced without delay. Consult a qualified specialist workshop. We recommend a Porsche partner for this work as they have trained workshop personnel and the necessary parts and tools.

Checks on test stands

Brake tests must be performed only on plate-type test stands or roller test stands.

The ignition must be off.

The following limit values must not be exceeded on roller test stands:

- Testing speed 8 km/h (5 mph)
- Test duration 20 seconds

Handbrake tests on the roller brake tester must **only be carried out with the ignition switched off.**

ABS Brake System

(anti-lock brake system)

Safety notes!

In spite of the advantages of ABS, it is still the driver's responsibility to adapt his driving style and manoeuvres in line with road and weather conditions, as well as the traffic situation.

The increased safety that is provided should not induce you to take greater risks with your safety. The limits set by the physics of driving cannot be overcome, even with ABS.

Risks of accident due to inappropriate speed cannot be reduced by ABS.

ABS ensures

Full steering control

- The vehicle remains steerable

Good driving stability

- No skidding due to locked wheels

Optimum braking distance

- Shorter stopping distances in most cases

Prevention of wheel locking

- No flat spots on the tyres

Function

The decisive advantage of ABS lies in the driving stability and manoeuvrability of the vehicle in hazardous situations.

The ABS prevents locking of the wheels during full braking, on almost all road surfaces, until shortly before the vehicle stops.

The ABS begins to control the braking process as soon as a wheel shows a tendency to lock.

This controlled braking process is comparable with extremely rapid cadence braking.

The pulsating brake pedal and a "juddering noise" warn the driver to adapt his driving speed to the road conditions.

- ▷ If full braking should be necessary, press the brake pedal all the way down throughout the entire braking procedure, regardless of the pulsating pedals. Do not ease up on pressure applied to the pedal.



Warning light

If the ABS warning lights light up on the instrument panel and on the on-board computer while the engine is running, the ABS has switched off because of a fault.

In this case, the braking system will operate **without lock prevention**, as in vehicles without ABS.

- ▷ Adapt your driving style to the changed braking behaviour.
The ABS must be checked by your Porsche partner in order to prevent the occurrence of further faults with unpredictable consequences.
- ▷ Consult a qualified specialist workshop. We recommend a Porsche partner for this work as they have trained workshop personnel and the necessary parts and tools.

The ABS control unit is adjusted for the approved tyre dimensions. The use of tyres with non-approved dimensions can lead to different wheel speeds, causing the ABS to switch off.

Sport Mode

A sportier car set-up is obtained and the overboost function is activated when Sport mode is switched on. Interventions by the Porsche control systems are intentionally shifted towards greater agility and driving performance:

- PASM (Porsche Active Suspension Management) is automatically changed to Sport mode, resulting in a stiffer suspension setup.
- When Sport mode is active, the Tiptronic S switches to a sporty gear-changing map and shortens the gear shifting times. Gear changes take place faster.

Precondition:

The engine speed of 3300 rpm must be exceeded once for at least 2 seconds.

- PSM (Porsche Stability Management) control is sporty. PSM interventions take place later than in Normal mode. The driver can manoeuvre the vehicle with greater agility at its performance limits, without having to dispense with the assistance of PSM in emergency situations.
- The electronic accelerator pedal reacts sooner, and the engine is more responsive to throttle inputs. When Sport mode is switched on, this function is activated only after the driver has floored the accelerator pedal or released it briefly.

- The rpm limiter characteristic is “harder”, i.e. the engine is immediately throttled when the performance limits are reached (only in manual selection mode for vehicles with Tiptronic S).
 - Overboost briefly increases the engine boost pressure by approx. 0.2 bar in the engine speed range from 2100 rpm to approx. 4000 rpm. This increases torque in this speed range by 60 Nm. This considerably improves acceleration and flexibility, particularly in the medium engine speed range. This does not affect the maximum power. Quickly flooring the accelerator pedal activates the overboost function in the engine control unit. An arrow appears next to the boost pressure display. Overboost has an effective operating time of approx. 10 seconds. After this time, it can be re-activated by quickly flooring the accelerator pedal again.
- ▷ Please observe the chapters on PSM, PASM and Tiptronic S.



Switching Sport mode on and off

- ▷ Press SPORT button in the centre console. When Sport mode is switched on, the light-emitting diode in the SPORT button is lit.



When Sport mode is switched on, the logo SPORT appears next to the digital speedometer. The arrow for the Overboost function appears next to the boost pressure gauge when the accelerator is depressed.

Switching Sport mode on and off simultaneously activates and deactivates the Sport mode of the PASM.

If PASM Sport mode was activated with the PASM button, PASM remains active.

After the ignition is switched off, Sport mode is automatically reset to Normal mode.

Porsche Stability Management (PSM)

PSM is an active control system for stabilisation of the vehicle during extreme driving manoeuvres. The further development of the PSM has improved the braking functions.

Danger!

- ▷ In spite of the advantages of PSM, it is still the driver's responsibility to adapt his driving style and manoeuvres in line with road and weather conditions, as well as the traffic situation.
- ▷ The increased safety that is provided should not induce you to take greater risks with your safety. The limits set by the physics of driving cannot be overcome, even with PSM. Risks of accident due to inappropriate speed cannot be reduced by PSM.

Sensors at the wheels, brakes, steering system and engine continuously measure:

- Speed
- Direction of travel (steering angle)
- Lateral acceleration
- Rate of turn about the vertical axis
- Longitudinal acceleration

PSM uses these values to determine the direction of travel desired by the driver.

PSM intervenes and corrects the course if the actual direction of motion deviates from the desired course (steering-wheel position): It brakes individual wheels as needed. In addition, the engine power may be manipulated in order to stabilise the vehicle.

The events below inform the driver of PSM control operations and warn him to adapt his driving style to the road conditions:

- The multi-functional information light on the instrument panel flashes.
- Hydraulic noises can be heard.
- The vehicle decelerates and steering-wheel forces are altered as the PSM controls the brakes.
- Reduced engine power.
- The brake pedal pulsates and its position is changed during braking.
In order to achieve full vehicle deceleration, foot pressure must be increased after the brake pedal has begun vibrating.

Examples of PSM control operations

- If the front wheels of the vehicle drift on a bend, the rear wheel on the inside of the bend is braked and the engine power is reduced if necessary.
- If the rear of the vehicle swings out on a bend, the front wheel on the outside of the bend is braked.
- Pre-filling the brake system:
The brake system is prepared for possible subsequent emergency braking if the accelerator pedal is released suddenly and quickly. The brake system is pre-filled, and as a result the brake pads then already slightly touch the brake discs.
- Brake booster:
In the event of an emergency braking operation where the pedal force is insufficient, a brake booster provides the braking pressure necessary for maximum deceleration at all 4 wheels.

Advantages of PSM

- Best possible traction and lane-holding ability in all driving situations – even on road surfaces with varying friction.
- The system compensates for undesired vehicle reactions (Ferraria effect) when the driver releases the accelerator pedal or brakes on bends. This compensation functions up to the maximum lateral acceleration.

- PSM actively stabilises the vehicle as required during dynamic driving manoeuvres (e.g. rapid steering movements, during lane changes or on alternating bends).
- Improved braking stability on bends and on different or varying road surfaces.
- It improves braking function and shortens stopping distance in the event of emergency braking (vehicles with four-wheel drive only).

Readiness for operation

PSM is switched on automatically every time you start the engine.

PSM should always be switched on during “normal” driving.

However, it may be advantageous to switch off PSM temporarily in exceptional situations, for example:

- On a loose surface or in deep snow,
- When “rocking the vehicle free” and
- When using snow chains.



Switching off PSM

- ▷ Press PSM OFF button.
PSM is switched off after a short delay.
The light-emitting diode in the button is lit up.
When the PSM is switched off, the multifunctional PSM light on the instrument panel is lit **and** a message is shown on the on-board computer.
An acoustic signal also sounds.

When PSM is switched off, the additional braking functions are deactivated. Automatic reactivation in emergency situations is coupled to the PSM control.

The following functions stabilise the vehicle in emergency situations, even with PSM switched off:

- When PSM is off, the vehicle is stabilised as soon as one of the two front wheels enters the ABS control range.
- When PSM is off and Sport mode is on, the vehicle is stabilised as soon as both front wheels enter the ABS control range.

One-sided spinning of the wheels is prevented, even with PSM switched off.

Switching PSM back on

- ▷ Press PSM OFF button.
PSM is switched on after a short delay.
The light-emitting diode in the button and the multi-functional PSM light on the instrument panel go out.
The on-board computer shows a message.

Sport mode

A sportier car set-up is obtained when Sport mode is switched on.

PSM interventions are later than in Normal mode; the vehicle can be manoeuvred with greater agility at its performance limits, without the need to dispense with the assistance of PSM in emergency situations. This helps to achieve optimal lap times, particularly on race circuits and a dry road surface.



Multifunction PSM light

- The multifunction light on the instrument panel lights up for a lamp check when the ignition is switched on.
- The light indicates a control operation by flashing, including when PSM is switched off (brake control in the event of one-sided wheel spin).
- In conjunction with a message on the on-board computer, the light indicates that PSM is switched off. An acoustic signal also sounds.
- The light indicates a fault in conjunction with a message on the on-board computer. PSM is out of order.

- ▷ Consult a qualified specialist workshop. We recommend a Porsche partner for this work as they have trained workshop personnel and the necessary parts and tools.
- ▷ Please observe the chapter “PUTTING VEHICLE INTO OPERATION” on page 216.

Towing

- ▷ Please observe the chapter “TOWING AND TOW-STARTING” on page 231.

Checks on test stands

Brake tests must be performed only on plate-type test stands or roller test stands.

The ignition must be off.

The following limit values must not be exceeded on roller test stands:

- Testing speed 8 km/h (5 mph)
- Test duration 20 seconds

Handbrake tests on the roller brake tester must **only be carried out with the ignition switched off.**



Porsche Active Suspension Management (PASM)

PASM makes two running-gear setups available to the driver: “Normal” and “Sport”.

The selection is made via a button on the centre console.

In Normal mode the running gear is in a sporty and comfortable setup.

Sport mode offers very sporty shock absorber tuning (e.g. for driving on the race circuit).

The variable suspension system selects the appropriate damping level for each wheel according to the situation and conditions of driving.

Example:

If the vehicle is driven in a very sporty manner in Normal mode, PASM automatically adapts the shock-absorber behaviour to the driving situation in this case as well.



Switching on PASM Sport mode

- ▷ Press PASM button in the centre console. When PASM Sport mode is switched on, the light-emitting diode in the button is lit up **and** a message is shown on the on-board computer.

Switching off PASM Sport mode

- ▷ Press PASM button in the centre console. The light-emitting diode in the button goes out **and** the on-board computer displays a message.

After the ignition is switched off, PASM is automatically reset to Normal mode.

Retractable Rear Spoiler

The rear spoiler improves driving stability, especially at higher speeds.



Risk of accident. If the rear spoiler cannot be extended, driving stability will be adversely affected by increased rear axle lift.

- ▷ Adapt your driving style and speed to the changed driving conditions.
- ▷ Have the fault remedied. Consult a qualified specialist workshop. We recommend a Porsche partner for this work as they have trained workshop personnel and the necessary parts and tools.

Risk of injury during manual retraction or extension of the rear spoiler with the vehicle stationary.

- ▷ Make sure that no persons or objects are within the range of movement of the rear spoiler.

Risk of damage from pushing the vehicle by the spoiler.

- ▷ Do not push the vehicle at the spoiler.
-

Automatic mode

Automatic extension and retraction of the spoiler depend on various circumstances (e.g. driving speed, engine compartment temperature).

Engine compartment temperature below 55 °C

Spoiler extends at 120 km/h (75 mph) and retracts at 60 km/h (37 mph).

Engine compartment temperature above 60 °C

Spoiler extends at 80 km/h (50 mph) and retracts at 30 km/h (20 mph).

If automatic control fails, a warning message is displayed by the on-board computer.



Manual control

When the ignition is on, the rear spoiler can be extended and retracted manually using the button in the centre console.

Extending

- ▷ Press button briefly.
The spoiler extends to its final position.
The light-emitting diode in the button lights up.

Retracting a manually extended rear spoiler

- ▷ **At speeds between 0 and 30 km/h (20 mph),**
press and hold button until the rear spoiler has reached its final position.
The light-emitting diode in the button goes out.
The rear spoiler changes to automatic mode.
- ▷ **At speeds between 30 and 100 km/h (20 and 60 mph),**
press button briefly.
The rear spoiler retracts, the light-emitting diode in the button goes out.
The rear spoiler changes to automatic mode.
- ▷ **At speeds over 100 km/h (60 mph),**
press button briefly.
The rear spoiler remains extended, the light-emitting diode in the button goes out.
The rear spoiler changes to automatic mode.

Parking Aids

ParkAssist

When the driver backs up, ParkAssist indicates the distance between the car and an obstacle by means of signal tones.



Warning!

Risk of accident. Even when using ParkAssist, the driver is still responsible for taking due care when parking and when assessing obstacles.

- ▷ Make sure that no persons, animals or obstacles are within the manoeuvring area.

ParkAssist is activated automatically when reverse gear is selected and the ignition is on.

Note

ParkAssist is not switched on if the car rolls backward without reverse gear engaged.



Ultrasound sensors

Sensors

Four ultrasound sensors in the rear bumper measure the distance to the closest obstacle.

- Range of middle sensors: approx. 150 cm
- Range of outer sensors: approx. 60 cm

Obstacles cannot be detected within the blind sensor area (e.g. near the ground).

- ▷ The sensors must always be kept free of dust, ice and snow in order to ensure that they are fully functional.
- ▷ Do not damage sensors by abrasion or scratching.

0471-028

- ▷ To avoid damaging the sensors, maintain sufficient distance when cleaning with steam-jet units.

Signal tones/function

When reverse gear is selected, ParkAssist confirms that it is switched on by issuing a **short signal tone**.

A detected obstacle is signalled by an **intermittent tone**. The intervals decrease as the obstacle is approached.

When the distance becomes less than approx. 30 cm, a **continuous tone sounds**. This continuous tone can stop if the obstacle is approached even closer.

- ▷ Set the radio volume so that the signal tones are not drowned out.

Limits of ultrasonic measurement

- ParkAssist cannot detect sound-absorbing obstacles (e.g. winter operation, powdery snow),
- sound-reflecting obstacles (e.g. glass surfaces, flat painted surfaces),
- and very thin obstacles.

Other sources of ultrasound (e.g. pneumatic brakes of other vehicles and jackhammers) may interfere with detection of obstacles.

Fault indication

- After reverse gear has been selected, the short signal tone is followed by a continuous tone of the same pitch.

Possible causes: Sensors are dirty or covered with ice or snow.

- After reverse gear has been selected, the short signal tone is followed by a continuous tone with a much lower pitch.

Possible causes: Fault or system fault.

- ▷ Have the fault remedied.
Consult a qualified specialist workshop. We recommend a Porsche partner for this work as they have trained workshop personnel and the necessary parts and tools.



A - Control switch for door mirror adjustment

Swivelling down mirror glass as parking aid

- ▷ Please observe the chapter “SEAT MEMORY” on page 25.

When reverse gear is engaged, the mirror on the **passenger's side** swivels down slightly to show the kerb area.

Preconditions

- Vehicle must be equipped with seat memory.
- Set the control switch **A** to “passenger's side”.
- Reverse gear must be engaged.

Returning mirror to its original position

- ▷ Drive forwards with a speed of over 6 km/h (4 mph) **or**
- ▷ Set the control switch **A** to “driver's side”.

Porsche Traction Management (PTM)

With PTM, the drive power is variably distributed to the front and rear wheels.

Power distribution between the front and rear axles is performed by a map-controlled multiple-disc clutch.

Distribution of the drive power also depends on the difference in wheel speed between the two axles.

The multiple-disc clutch always delivers sufficient drive power to the front wheels to ensure optimum propulsion even on an unfavourable road surface.

In combination with Porsche Stability Management (PSM), the PTM ensures optimum handling and high driving stability.

Danger!

In spite of the advantages of PTM, it is still the driver's responsibility to adapt his/her driving style and manoeuvres in line with road and weather conditions, as well as the traffic situation.

The increased safety that is provided should not induce you to take greater risks with your safety. The limits set by the physics of driving cannot be overcome, even with PTM.

Risks of accident due to inappropriate speed cannot be reduced by PTM.

Checks on test stands

Power measurement

Performance tests on roller test stands are not approved by Porsche.

Brake tests

Brake tests must be performed only on plate-type test stands or roller test stands.

The ignition must be off.

The following limit values must not be exceeded on roller test stands:

- Testing speed 8 km/h (5 mph)
- Test duration 20 seconds

Handbrake check

Handbrake tests on the roller brake tester must **only be carried out with the ignition switched off.**

Balancing wheels on the vehicle

During finish balancing of the wheels, the vehicle must be lifted and the wheels must be free to turn.

Towing

- ▷ Please observe the chapter "TOWING AND TOW-STARTING" on page 231.

Wheels/tyres

The PTM control unit is adapted to the approved tyre sizes. The use of non-approved tyre sizes may lead to deviations in wheel speeds and it may influence handling or result in the PTM switching off.

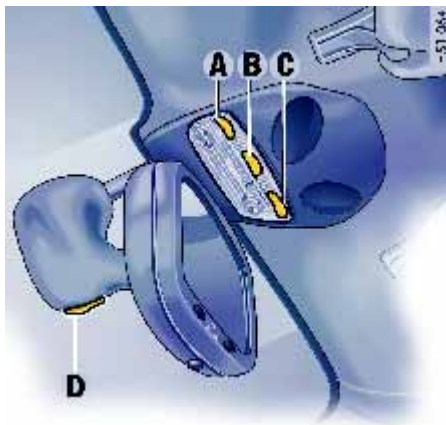

A, C - Switch for reading light on driver/passenger side
B - Switch for interior light and footwell lights
D - Orientation light

Interior Lights

- ▷ Please observe the chapter “LOAD SWITCH-OFF AFTER 2 HOURS OR 7 DAYS” on page 211.
- ▷ Switch off the automatic anti-dazzle operation of the mirrors before you switch on the interior light. Otherwise the mirrors may accidentally swivel into the anti-dazzle position.

Interior lights, reading lights

Switching off

- ▷ Press left half of switch.

Switching to continuous illumination

- ▷ Press right half of switch.

Switching on and off automatically

- ▷ Move switch to centre position.

The interior and footwell lights are **switched on** when a door is unlocked or opened or when the ignition key is withdrawn from the ignition lock.

The interior lights are **switched off** with a delay of approx. 2 minutes after the doors are closed.

The light goes out immediately as soon as the ignition is switched on or the vehicle is locked.

Orientation light

A light-emitting diode at the bottom of the interior mirror improves orientation in the passenger compartment when it is dark.

Note on operation

On vehicles with Sport Chrono Turbo package, the brightness of the orientation light can be changed in PCM.

- ▷ Please observe the chapter “Individual Memory” in the separate PCM operating instructions.

Controls, Instruments

1. Ignition lock/steering lock
2. Direction indicator/high beam/headlight flasher stalk
3. Hands-free microphone for telephone
4. Horn
5. Wiper/washer lever, rear window wiper
6. Button for seat heating, left
7. Interior temperature sensor/GPS antenna
8. Stopwatch
9. Button for hazard warning lights
10. Central locking button, readiness display for alarm system
11. Porsche Communication Management (PCM)
12. Button for seat heating, right
13. Cupholder
14. Light switch
15. Operating lever for on-board computer
16. Locking lever for steering-wheel adjustment
17. Operating lever for cruise control
18. Operating panel for air conditioning
19. Buttons for rear spoiler, Porsche Active Suspension Management (PASM), Sport mode, Porsche Stability Management (PSM)

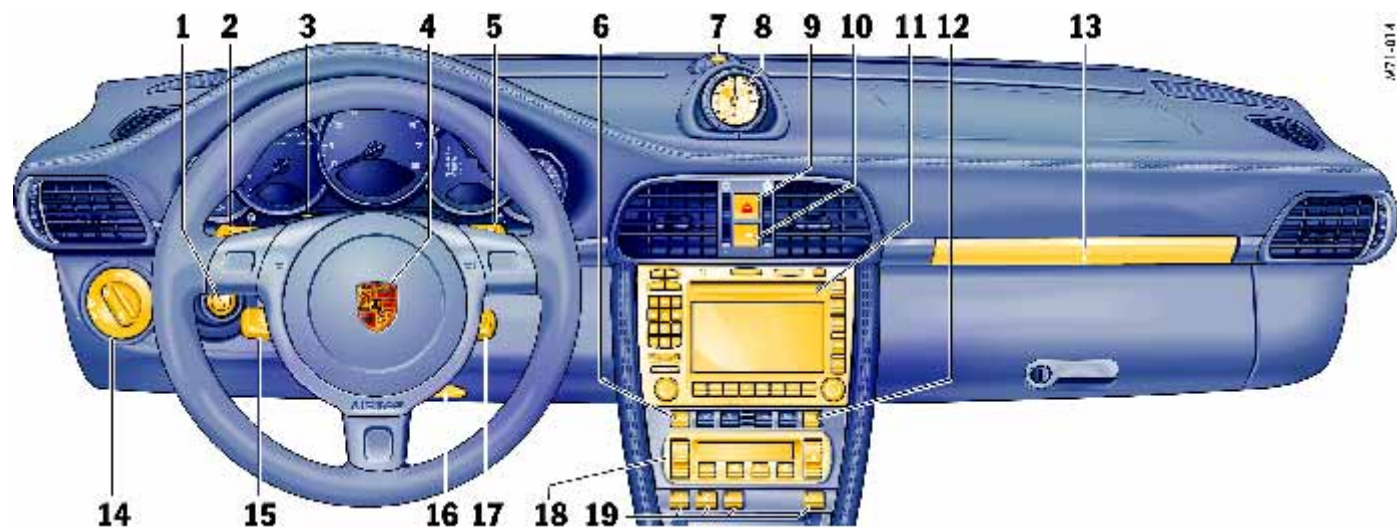



- 0 - Initial position
- 1 - Ignition on
- 2 - Start engine
- 3 - Ignition off

Ignition Lock/Steering Lock

The ignition lock has a total of four ignition lock positions.

The vehicle key rebounds to the initial position from every ignition lock position.

Ignition lock position 0

Initial position

The ignition key cannot be withdrawn when the ignition is switched on or when the engine has been started.

To withdraw the ignition key:

- ▷ Stop the vehicle.
- ▷ **On vehicles with Tiptronic S:**
Move Tiptronic selector lever to position **P**.
- ▷ Switch ignition off.
- ▷ Remove ignition key.

Ignition lock position 1

Ignition on

- ▷ Turn ignition key to position **1**.
Ignition is switched on.

Note on operation

All electrical equipment can be switched on.

- ▷ Please observe the chapter “WARNINGS ON THE INSTRUMENT PANEL AND THE ON-BOARD COMPUTER” on page 106.

Ignition lock position 2

Start engine

- ▷ Turn ignition key to ignition lock position **2**.
- ▷ Please observe the chapter “STARTING AND STOPPING THE ENGINE” on page 62.

Ignition lock position 3

Ignition off

- ▷ Turn ignition key to ignition lock position **3**.

Locking the steering column

Automatic locking

The steering column is automatically locked when the ignition key is withdrawn from the ignition lock.

- ▷ **Withdraw the ignition key only when the vehicle is stationary, otherwise the steering lock engages and the vehicle cannot be steered.**
- ▷ When leaving the vehicle **the ignition key must always be removed.**

Automatic unlocking

The steering column is automatically unlocked when the ignition key is inserted into the ignition lock.



Emergency operation – releasing the ignition key

If the vehicle battery is dead, the key can be pulled out only if the emergency operation is performed.

1. Grasp the fuse box cover at the finger hole and it pull off.
2. Unclip metal hook **A** on the inside of the cover.

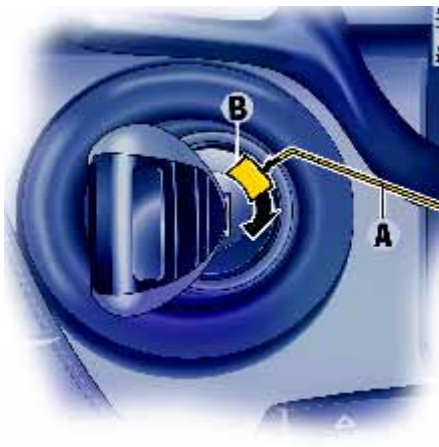

3. Use metal hook **A** to remove the plastic cover **B** from the ignition lock. Make sure that plastic cover **B** is not lost.

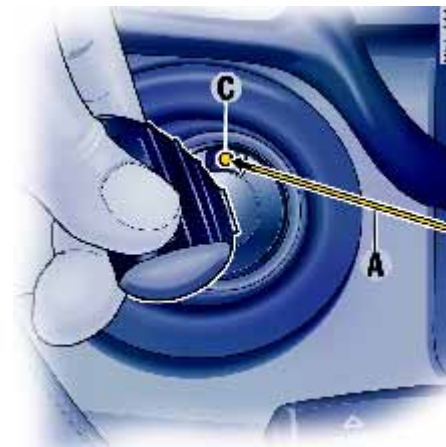

4. Turn ignition key counter-clockwise as far as it will go.
5. Press metal hook **A** into opening **C**. An unlocking sound will be heard.
6. Turn the ignition key to initial position **O** and remove.
7. Re-fit the plastic cover **B**.

Starting and Stopping the Engine

- ▷ Please observe the chapter “IMMOBILISER” on page 10.
- ▷ Please observe the chapter “EMISSION CONTROL SYSTEM” on page 182.

Warning!

Risk of poisoning. Exhaust gas contains colourless and odourless carbon monoxide, which is toxic even in low concentrations.

- ▷ Never start the engine or let it run in confined spaces.

Danger of fire in the area of the hot exhaust system.

- ▷ Do not park or drive your car where combustible materials, such as dry grass or leaves, can come into contact with the hot exhaust system.

Starting

- ▷ Operate footbrake.
- ▷ Fully depress and hold the clutch pedal.
- ▷ Put gearshift lever into neutral or move Tiptronic selector lever to the **P** or **N** position.
- ▷ Do not press the accelerator pedal. The engine control unit will provide the correct starting mixture.
- ▷ Do not operate the starter for longer than approx. 10 seconds. If necessary, repeat the starting procedure after a pause of approx. 10 seconds. Turn the ignition key back to position **3** first.

The first operation of the starter is ended automatically when the engine starts.

If the engine does not start, subsequent starter operations will not be ended automatically.

- ▷ Do not warm up the engine when stationary. Drive off immediately. Avoid high revolutions and full throttle until the engine has reached operating temperature.

If battery output is insufficient, jump leads can be used to start the engine. Vehicles with manual transmission can also be tow-started.

- ▷ Please observe the chapter “JUMP LEAD STARTING” on page 218.

- ▷ To ensure a good charge condition for the battery and thus its ability to start the engine, all electrical accessories which are not required should be switched off when the ignition is switched on and when engine revolutions are low (in traffic jams, in cities or in queues).

Stopping

- ▷ Only switch the ignition off when the vehicle is stationary, as there is no steering assistance and brake boost when the engine is switched off.
- ▷ Withdraw the ignition key only when the vehicle is stationary, otherwise the steering lock engages and the vehicle cannot be steered.
- ▷ **Always** withdraw the ignition key and engage the parking brake when leaving the vehicle.

Note

The vehicle battery would be discharged rapidly if the ignition key is left inserted.

- ▷ Please observe the chapter "LOAD SWITCH-OFF AFTER 2 HOURS OR 7 DAYS" on page 211.

Engine-compartment blower, radiator fans

The radiators and radiator fans are in the front of the vehicle.

The engine-compartment blower is mounted on the engine compartment lid.

Warning!

Risk of injury. After the engine is switched off, the engine compartment temperature is monitored for approx. 30 minutes. During this period, and depending on temperature, the engine-compartment blower may continue to run or start to run.

- ▷ Carry out work in these areas only with the engine off and exercise extreme caution.

Risk of injury. The radiator fans in the front end of the car may be operating or unexpectedly start operating when the engine is switched on.

- ▷ Carry out work in these areas only with the engine switched off.
-

Instrument panel

You will find information on each indicator in the corresponding chapter.

- 1.Engine oil temperature display
- 2.Analogue speedometer
- 3.Tyre pressure warning light
- 4.Direction indicator, left
- 5.Tachometer
- 6.High beam indicator light
- 7.Direction indicator, right
- 8.ABS warning light
- 9.Cooling system
Temperature gauge and warning light
- 10.Fuel
Level gauge and warning light
- 11.Engine oil pressure gauge
- 12.Adjustment button for instrument illumination
and
trip counter
- 13.Odometer and daily trip mileage display
- 14.Cruise control indicator light
- 15.Light sensor for instrument illumination
- 16.Airbag warning light
- 17.Emission control warning light
(Check Engine)
- 18.Central warning light
- 19.On-board computer display
- 20.Porsche Stability Management
(PSM) multifunction light
- 21.Brake warning light
- 22.Seat belt warning light
- 23.Tiptronic indicator
- 24.Clock and outside temperature display
- 25.Adjustment button for clock

When the ignition is switched on, the warning lights light up for a lamp check.

Note

Warnings that have appeared are stored in the corresponding control unit memory and can be read out at a Porsche partner.

This information can also be used to protect you or Porsche from unjustified claims.





Engine Oil Temperature

The engine oil temperature is indicated in the left instrument.



A - Adjustment button for instrument illumination and trip counter



Cruise Control Indicator Light

The indicator light indicates that the cruise control is ready for operation.

Instrument Illumination

The illumination is automatically adjusted to the ambient brightness by the light sensor in the analogue tachometer.

In addition, when the car lights are switched on, the instrument and switch brightness can be manually adjusted.



Warning!

Risk of accident when adjusting brightness whilst driving. You may lose control of the vehicle.

- ▷ Do not reach through the steering-wheel spokes while driving.

Note

When the vehicle lights are switched on, the scale lighting for light-coloured dials is switched on and off automatically depending on ambient brightness.



H62-530
M72-0-0



Dimming instrument illumination

- ▷ Turn adjustment button **A** in the appropriate direction and hold it until the desired brightness has been reached. The chosen level of brightness is indicated by a bar display in the display field of the on-board computer.

Trip Counter



Risk of accident when resetting the trip counter whilst driving. You may lose control of the vehicle.

- ▷ Do not reach through the steering-wheel spokes while driving.

Resetting to 0 km

- ▷ Press adjustment button **A** for approx. 1 second **or**
- ▷ Reset the distance in the “SET” menu of the on-board computer.
- ▷ Please observe the chapter “ON-BOARD COMPUTER (BC)” on page 76.

After exceeding 9999 kilometres or 6213 miles, the counter returns to 0.



Speedometer

The digital speedometer is integrated in the on-board computer display.

The indication changes from km/h to mph when the units are changed from kilometres to miles.

Changing Over Between Kilometres/Miles

The units of the distance and speed displays can also be changed in the SET menu of the on-board computer.

- ▷ Please observe the chapter “SET BASIC SETTING OF ON-BOARD COMPUTER” on page 103.



5471-002

←→ Direction Indicator

The pilot light flashes in time with the direction indicator lights.

Left arrow – left indicator

Right arrow – right indicator

If the rhythm of the display becomes noticeably faster, check operation of the direction indicator lights.

≡ High Beam

Indicator light

The indicator light is lit when high beam or headlight flasher is switched on.

Tachometer

The start of the red zone on the tachometer scale is a visual warning of the maximum permissible engine speed.

If the red zone is reached during acceleration, fuel feed is interrupted in order to protect the engine. Before changing down to a lower gear, make sure you will not exceed the maximum permissible changing-down rpm.



H61-204

Pointer in the middle – normal operating temperature

Pointer may move up to the red area when engine is heavily loaded and outside temperature is high.

Warning light “A”

The temperature gauge **warning light lights up** if the coolant temperature is too high. Additionally, a warning is displayed on the on-board computer.

- ▷ Switch engine off and let it cool.
- ▷ Check radiators and air passages in front end of vehicle for obstructions.
- ▷ Check coolant level. Add coolant if necessary.
- ▷ Have the fault repaired.
- ▷ Please observe the chapter “COOLANT LEVEL” on page 177.

Note

To prevent excessive temperatures, the cooling air ducts must not be obstructed by coverings (e.g. films or “stone guards”).

The temperature gauge **warning light flashes** if the coolant level is too low. Additionally, a warning is displayed on the on-board computer.

- ▷ Switch engine off and let it cool.
- ▷ Add coolant.
- ▷ Have the cause for the fault remedied.
- ▷ Please observe the chapter “COOLANT LEVEL” on page 177.

! Caution!

Risk of engine damage.

- ▷ Do not continue driving if the warning lights come on or flash even when the coolant level is correct.
- ▷ Have the fault repaired.

⚙ Cooling System

- ▷ Please visit a qualified specialist workshop in the event of faults in the cooling system. We recommend a Porsche partner for this work as they have trained workshop personnel and the necessary parts and tools.

Temperature gauge (ignition on)

Pointer to the left – engine cold

- ▷ Avoid high engine speeds and heavy engine loading.

Engine-compartment blower

The temperature gauge **warning light flashes** if the engine-compartment blower is not working. Additionally, a warning is displayed on the on-board computer.

- ▷ Have the cause for the fault remedied.

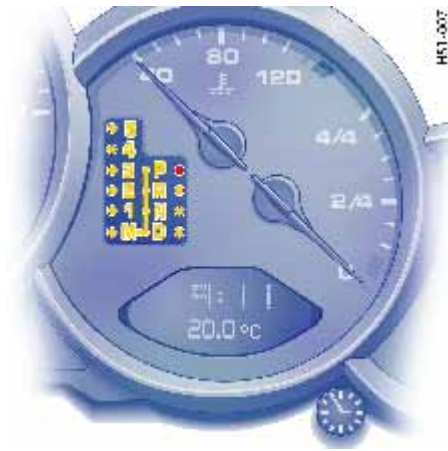

Tiptronic S

Indicator for Tiptronic selector lever position and engaged gear

When the engine is running, the selector lever position and engaged gear are indicated.

If the selector lever is between two positions:

- The corresponding selector lever position in the instrument cluster flashes **and**
- The warning "Selector lever not engaged" appears on the on-board computer.
- ▷ Engage the selector lever correctly.

If there is a fault in the transmission:

- The **4th gear** display flashes.
- The warning "Tiptronic emergency run" appears on the on-board computer.
- ▷ Please observe the chapter "REDUCED DRIVING PROGRAMME" on page 148.
- ▷ Have the fault repaired immediately. Consult a qualified specialist workshop. We recommend a Porsche partner for this work as they have trained workshop personnel and the necessary parts and tools.
- ▷ Please observe the chapter "TIPTRONIC S" on page 143.



Fuel

Level gauge

When the ignition is on the fuel level is displayed.

- ▷ Please observe the chapter “CAPACITIES” on page 241.

If the vehicle's inclination changes (e.g. going uphill/downhill), minor deviations in the indication may occur.

HET 0006

Note

If the tank is nearly empty and you top up with only a small quantity of fuel, this cannot be registered by the level gauge and cannot be used to calculate the range on remaining fuel.

Warning light “A”

If less than approx. 10 litres remains in the tank, **the warning light for the level gauge lights up when the engine is running.**

Additionally, a warning is displayed on the on-board computer.

- ▷ Fill up at the next opportunity.

Caution!

A shortage of fuel may cause damage to the emission control system.

- ▷ Never drive the tank dry.
 - ▷ If the warning lights have come on, do not take bends at high speed.
-
- ▷ Please observe the chapter “EMISSION CONTROL SYSTEM” on page 182.

If the fuel gauge warning light flashes, there is a fault in the system.

Additionally, a warning is displayed on the on-board computer.

There will then be no reserve warning.

- ▷ Have the fault remedied.
Consult a qualified specialist workshop. We recommend a Porsche partner for this work as they have trained workshop personnel and the necessary parts and tools.



- A - Adjustment button for clock
- B - Clock
- C - Outside temperature display

Clock

The clock is blanked out approx. 4 minutes after the ignition is switched off or when the car is locked.

Setting the time



Warning!

Risk of accident when setting the clock whilst driving. You may lose control of the vehicle.

- ▷ Do not reach through the steering-wheel spokes while driving.
- ▷ Switch on ignition.

Setting hours

- ▷ Press adjustment button **A** for approx. 1 second.
Hour display flashes.
- ▷ Turn button in the appropriate direction:
to the right – increase hours figure
to the left – decrease hours figure

Adjustment in hours –
turn button briefly
Fast adjustment (display cycles) –
turn and hold button

Setting minutes

- ▷ Press adjustment button again.
Minutes display flashes.
- ▷ Set by turning as in hours mode.

Leaving adjustment mode

Automatically after one minute **or**:

- ▷ Press adjustment button again.

When adjustment mode is deliberately left by pressing the button, the time begins precisely to the second.

Note

The time mode can be changed between 12h and 24h in the on-board computer.

Outside Temperature

The outside temperature display **C** is not an ice-warning indication.
The road surface may be icy even if temperatures above 0 °C are displayed, especially on bridges and shady sections of road.



Engine Oil Pressure

With the engine warmed up and running at a speed of 5000 rpm, the engine oil pressure should be approx. 4.5 bar or higher.

1915-14-002

If oil pressure drops abruptly and a message is displayed on the on-board computer when the engine is running or while driving:

- ▷ Stop immediately in a suitable place.
- ▷ Switch off the engine.
- ▷ Check whether there is an obvious oil leak on or under the car.
- ▷ If no oil leak can be detected: With the engine idling, measure the oil level with the on-board computer.
- ▷ Please observe the chapter “ON-BOARD COMPUTER (BC)” on page 76. Please observe the chapter “ENGINE OIL LEVEL” on page 179.
- ▷ Add engine oil if necessary.

Caution!

Risk of engine damage.

- ▷ Do not continue driving if there is an obvious oil leak.
- ▷ Do not continue driving if the warning message appears even when the oil level is correct.
- ▷ Have the fault remedied. Consult a qualified specialist workshop. We recommend a Porsche partner for this work as they have trained workshop personnel and the necessary parts and tools.



Battery/Generator

If the battery voltage drops abruptly, a warning message will be shown by the on-board computer.

If the warning message is shown when the engine is running or while driving:

- ▷ Stop at a safe place and switch the engine off.

Possible causes:

- Defect in the battery charging system
- Broken drive belt

Warning!

Risk of accident and risk of engine damage. A broken drive belt means there is no power assistance to the steering (more effort is required to steer) and engine cooling fails.

- ▷ Do not continue driving.
- ▷ Have the fault remedied.
- ▷ Consult a qualified specialist workshop. We recommend a Porsche partner for this work as they have trained workshop personnel and the necessary parts and tools.

Central warning light

The central warning light on the instrument panel lights up if there are warning messages in the INFO menu.

The messages can be called in the on-board computer INFO menu:

- ▷ Please observe the chapter “INFO WARNING MESSAGES” on page 82.

Brake warning light

The warning light on the instrument panel lights up:

- if the handbrake is on,
- if the brake fluid level is low,
- if the brake pads have reached the wear limit,
- if the brake-power distribution is defective.

Additionally, a warning is displayed by the on-board computer.

- ▷ Please observe the chapter “WARNINGS ON THE INSTRUMENT PANEL AND THE ON-BOARD COMPUTER” on page 106.

Emission Control

Warning light

The emission control system detects malfunctions early that could, for example, cause increased pollutant emissions or consequential damage. Faults are indicated by the warning lights on the instrument panel and on the on-board computer being continuously lit or flashing. The identified faults are recorded in the control unit's fault memory.

The warning light on the instrument panel lights up when the ignition is switched on as a lamp check and goes out approx. 4 seconds after the engine starts.

The warning light on the instrument panel flashes to indicate operating states (e.g. engine misfiring) which might cause damage to certain parts of the emission control system. Additionally, a warning is displayed on the on-board computer.

- ▷ In this case, immediately reduce the engine load by easing off the accelerator. The warning light in the instrument panel is lit continuously after the critical range is left.

In order to avoid consequential damage to the engine or the exhaust-gas cleaning system (e.g. catalytic converter):

- ▷ Please drive at a moderate speed and visit a specialist workshop. We recommend a Porsche partner for this work as they have trained workshop personnel and the necessary parts and tools.

Caution!

Risk of damage. If the warning light in the instrument panel continues flashing even when you have eased off the accelerator pedal, the emission control system may overheat.

- ▷ Stop as soon as possible in a safe place. Make sure that combustible materials, such as dry grass or leaves, cannot come into contact with the hot exhaust system.
 - ▷ Switch off the engine.
 - ▷ Please have the fault analysed and remedied by a qualified workshop.
-



112-003



101 023

On-Board Computer (BC)

Display field

The display field is beneath the tachometer.

Readiness for operation

- With ignition switched on,
- With engine running.

Operation

It is not possible to describe all details of the on-board computer functions in this Driver's Manual. However, the examples will quickly familiarise you with the basic principles of operation and help you to navigate through the menu structure.

You can restore the factory default settings at any time by using the "SET" menu.

Operating lever

The on-board computer is operated with the lower left lever on the steering column.

Selecting functions of the on-board computer

- ▷ Push lever up **3** or down **4**.

Confirming selection (Enter)

- ▷ Push the lever forward **1**.

Moving back one or several selection levels

- ▷ Pull the lever back **2** once or several times **or**
- ▷ Select the arrow  on the on-board computer display with the operating lever and push the operating lever forward **1**.

Note

You can always return to the basic menu by pulling the operating lever several times.

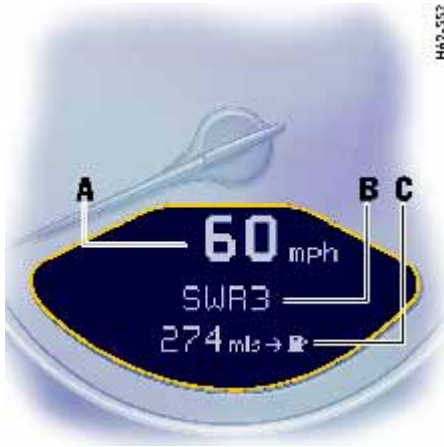

A - Digital speedometer
B - Central display
C - Bottom display

Functions and display possibilities

Note

The available items and displays in the on-board computer depend on the equipment of your vehicle. For this reason it is possible that some of the items and displays shown here are not available in your on-board computer.

Basic setting

- Central display: Radio station

The central line **B** of the on-board computer can be selected in the SET menu.

Calling on-board computer functions in display “C”

- ▷ Push the operating lever up or down (selection field **D** must be switched off).

The following displays can be called step by step:

- Average speed (Ø mph),
- Average consumption (Ø mpg),
- Range on remaining fuel (miles ⇄ ⛽),
- Tyre pressure,
- Engine boost pressure (digital display)
- Engine boost pressure (bar display)
- Navigation information (if activated in the SET menu).

Note

The values “Average speed”, “Average consumption” and “Daily trip mileage” can be reset to zero in the SET menu.

Switching selection field “D” on or off

- ▷ Push operating lever forward or back.

Arrow symbol “E” for continuation

Arrow symbol: ↙

- ▷ Push operating lever down in order to continue the menu.

Arrow symbol: ↘

- ▷ Push operating lever up in order to continue the menu.

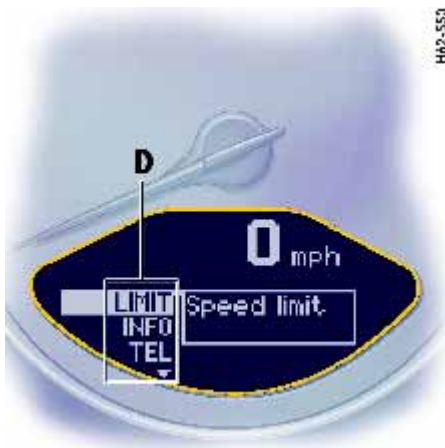

D - Selection field



E - Arrow symbols for continuation



LIMIT

Acoustic Warning Signal for Speed Limit

The acoustic warning signal can be activated for speeds above 10 km/h (6 mph).

The signal sounds when the preset speed is exceeded.

For the signal to sound again, the driving speed must fall below the preset speed by at least 5 km/h (3 mph).

Switching on selection field "D"

- ▷ Push operating lever forward.



Setting the speed

- ▷ Select LIMIT with the operating lever.



- ▷ Push operating lever forward.



H42-510



H42-512



H42-511

Option 1:
Accepting current speed

- ▷ Push operating lever forward.

The acoustic warning signal is activated for the current speed.

Display:

Option 2:
Presetting speed

- ▷ Select "LIMIT active" with the operating lever:

- not active
- active

- ▷ If "not active", push the operating lever forward.

- ▷ Select "xx mph" with the operating lever.
- ▷ Push operating lever forward.



HAZ-510

Switching the acoustic warning signal off

- ▷ Select "LIMIT active" with the operating lever.
- ▷ Push operating lever forward.

Display:

- ▷ Push operating lever slightly up or down until the desired speed is reached.

upwards: speed is increased
downwards: speed is decreased

Note:

Holding the lever pressed up or down for a longer period will adjust the speed in increments of 10 mph.

- ▷ Push operating lever forward.



H42-513



H42-513



- 82 - 2 - 4

INFO Warning messages

Switching on selection field "D"

- ▷ Push operating lever forward.

Calling warning messages

- ▷ Select INFO with the operating lever.

- ▷ Push operating lever forward.

Any existing warning messages can be called using the operating lever. You also can call warning messages which were acknowledged during the journey (only until the next time the ignition is switched on).

- ▷ Push operating lever forward.
- ▷ Push operating lever forwards or pull backwards.
The display returns to the Info menu.



TEL Telephone information

Switching on selection field "D"

- ▷ Push operating lever forward.

Recalling telephone information

- ▷ Select TEL with the operating lever.

- ▷ Push operating lever forward.

Note

You can recall phone calls, e.g. calls that arrived during your absence, via the menu item "Missed calls".



H42-561



H42-562



H42-564

**Example:
Selecting from the telephone book and
calling**

▷ Select “Phone book” with the operating lever.

- ▷ Push operating lever forward.
- ▷ Select a person to call and push the operating lever forward.
The connection is established.

- ▷ Push the operating lever forward to end the call.



Incoming call

- ▷ Select “Accept” or “Refuse” and push the operating lever forward.

Note

Rejected phone calls can be recalled with menu item “Missed calls”.



CHRONO Stopwatch

You can use the stopwatch to measure any times, e.g. on the race circuit or on work-related journeys. Measured lap times can be stored and evaluated if the vehicle is equipped with Porsche Communication Management (PCM).

- ▷ Please observe the chapter “Sport display” in the separate PCM operating instructions.

Stopwatch on the instrument panel

The stopwatch has an analogue and a digital display.

The large pointer of the analogue display measures the seconds. The two small pointers measure hours and minutes. The display re-starts at zero after 12 hours.

Seconds and increments of 1/100th of a second can be read on the digital display.

The digital display and the display in the on-board computer can indicate up to 99 hours and 59 minutes.

The stopwatch can be swivelled both to the left and to the right.

Stopwatch displays:

- on the stopwatch on the instrument panel,
- in the on-board computer menu CHRONO,
- on the performance display in the PCM.

Starting/stopping stopwatch

All stopwatch displays are started and stopped via the on-board computer menu CHRONO.

Notes on operation

If you leave the CHRONO menu while the stopwatch is running, measurement will continue.

The stopwatch stops after the ignition is switched off. If the ignition is switched on again within approx. 4 minutes, the stopwatch will continue to run.

The only way to reset the stopwatch to zero is by selecting “Reset” in the CHRONO menu.



Starting timing

- ▷ Push operating lever forward.
The selection field is switched on.
- ▷ Select CHRONO with the operating lever.

- ▷ Push operating lever forward.

- ▷ Push operating lever forward.
The time runs on all stopwatch displays.
The on-board computer display changes to the “Stop timing/Interm. time” selection.

Note PCM

The performance display in the “Trip/Sport display/Begin trip” menu must be selected in order to analyse the data in the PCM.



Stopping timing

After time measurement is started, the on-board computer display changes to the “Stop timing/Interm. time” selection.

- ▷ Select “Stop timing” with the operating lever.



- ▷ Push lever forward.

The time is stopped in all stopwatch displays and the on-board computer display changes to the “Continue/Reset” selection.

Timing can be continued or reset to zero.

Note PCM:

After timing has been stopped, a prompt asking whether the time is to be stored appears on the PCM.



Continue timing

After timing has been stopped, the on-board computer display changes to the “Continue/Reset” selection.



- ▷ Push operating lever forward.
The stopwatch displays continue timing.

The on-board computer display returns to the "Stop time/Interm. time" selection. You can stop the stopwatch or measure an intermediate time.

Resetting the time

After timing has been stopped, the on-board computer display changes to the "Continue/Reset" selection.

- ▷ Select "Reset" with the operating lever.

- ▷ Push operating lever forward.
The display returns to the "Start timing" selection.
The stopwatch displays on the instrument panel and the on-board computer are reset to zero.

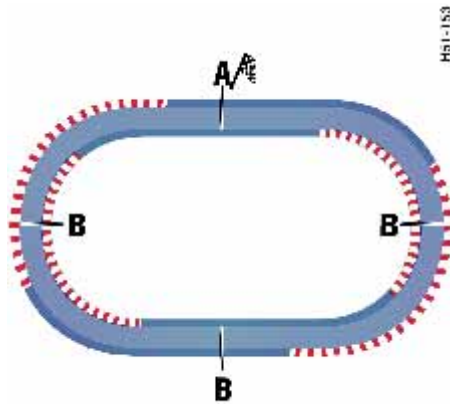

A - Lap
B - Intermediate time

Displaying intermediate times

Several intermediate times can be displayed for a route or for a lap on the race circuit. The intermediate times **B** are for your information. Measured lap times **A** can be stored and evaluated if the vehicle is equipped with Porsche Communication Management (PCM).



To display an intermediate time:

After timing has been started, the on-board computer display changes to the “Stop timing/ Interm. time” selection.



- ▷ Select “Interm. time” with the operating lever and push the operating lever forwards.



The intermediate time will be displayed for approx. 5 seconds.

The on-board computer display then returns to the “Stop timing/Interm. time” selection.

- ▷ You can stop the stopwatch or measure another intermediate time.

Starting a new lap time measurement

The “New lap?” selection appears for 5 seconds after selection of “Interm. time”.

- ▷ Select “New lap?” with the operating lever and push the operating lever forwards.

The new lap is displayed on the on-board computer and the PCM. Timing on the on-board computer and on the PCM begins from zero. The stopwatch on the instrument panel continues to show the total time.



- ▷ The on-board computer display returns to the “Stop timing/Interm. time” selection after a short period.
- ▷ You can stop the stopwatch or measure another intermediate time or a new lap.

Note for PCM:

If you wish to store the lap time in the PCM, the performance display in the “Trip/Sport display/Begin trip” menu of the PCM must be selected.

TPM Tyre Pressure Monitoring

Tyre Pressure Monitoring continuously monitors tyre pressure and tyre temperature on all four wheels and warns the driver when the tyre pressure is too low.

The display as well as the settings for Tyre Pressure Monitoring take place on the on-board computer. However, you must still adjust the tyre pressure at the wheel.

- ▷ The driver is responsible for filling the tyres correctly and making the correct settings on the on-board computer.

Tyre Pressure Monitoring offers the following functions:

- Display of the actual tyre pressure while the vehicle is in motion.
- Display of the deviation from the required pressure (refilling pressure).
- Display of currently set tyre size and type.
- Tyre pressure warnings in two stages.

Caution!

Despite the advantages offered by Tyre Pressure Monitoring, it is still the driver's responsibility to update the corresponding settings in the on-board computer and maintain the pressure in the tyres. Low tyre pressure reduces the road safety of the vehicle and destroys the tyre and wheel.

- ▷ When a flat tyre has been displayed, immediately stop in a suitable place and check the tyres for damage. If necessary, remedy the damage with a tyre sealant.
- ▷ Do not by any means continue to drive with defective tyres.
- ▷ Sealing the tyre with tyre sealant is only an emergency repair, so you can drive to the next specialist workshop. The maximum speed is **80 km/h (50 mph)**.
- ▷ Do not drive with tyres whose tyre pressure drops again in a short period of time. In cases of doubt, have tyres checked by a specialist workshop.
- ▷ Defective tyres must be immediately replaced by a specialist workshop.
Tyre repairs are not permissible under any circumstances.

- ▷ If Tyre Pressure Monitoring is defective (e.g. defective wheel transmitters), contact a specialist workshop immediately and have the damage repaired.
The tyre pressure will not be monitored by defective Tyre Pressure Monitoring.
- ▷ Use only the pressure differences shown in the "Info pressure" display in the Tyre pressure menu or from the corresponding tyre pressure warning when correcting the tyre pressure.
- ▷ Tyres lose air over time without a tyre defect being present. A tyre pressure warning will then appear on the on-board computer display. Correct the tyre pressure at the next opportunity.
- ▷ Tyre Pressure Monitoring gives a warning about tyre damage due to natural pressure loss as well as about a gradual loss of pressure due to foreign objects.
Tyre Pressure Monitoring cannot warn you about tyre damage that occurs suddenly (e.g. flat tyre due to abrupt external effects).



H42-501

Tyre pressure function of the on-board computer

The tyre pressure function of the on-board computer displays the tyre pressures (actual pressure) dependent on temperature in the four wheels.

You can watch the tyre pressure rise as the temperature increases while driving.

This display is only for information.

- ▷ Under no circumstances should the tyre pressures be changed based on this display.

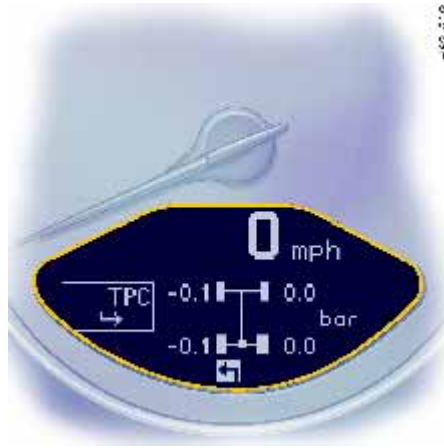

-52-109

Calling the tyre pressure function of the on-board computer

- ▷ Push operating lever up or down until the tyre pressure function of the on-board computer appears.
(Selection field must be **switched off**.)

Pressure info in Tyre pressure menu

In accordance with physical principles, the air pressure changes as the temperature changes. For every 10 °C (18 °F) change in temperature, the tyre pressure increases or decreases by around 0.1 bar (1.5 psi).

Tyre Pressure Monitoring takes this relationship between tyre pressure and temperature into account.

You can read the tyre pressures to be corrected on this display.

The tyre pressure to be corrected (refill pressure) is indicated on the displayed wheel.

Example: If “-0.1 bar (-1.5 psi)” is displayed, 0.1 bar (1.5 psi) must be added to this tyre.

Note

The Tyre pressure menu can only be called up when the vehicle is stationary.

Calling up the “Info pressure” display

- ▷ Push operating lever forward in order to switch on the selection field.
- ▷ Select “TPM” with the operating lever.
- ▷ Push operating lever forward.
The display changes to the Tyre pressure menu.
- ▷ Select “Info pressure” with the operating lever.
- ▷ Push operating lever forward.

Note

After the ignition is switched on, it can take up to approx. 1 minute before all tyre pressures are displayed. Dashes (“-.”) appear instead of the tyre pressures.



H72-575



H42-50a



H42-517

Tyre type info in Tyre pressure menu

Information about the currently set tyres:

- Tyre type:
Summer tyres, winter tyres

"Info tyres" shows the current tyre settings.

Calling up the "Info tyres" display

- ▷ Push operating lever forward in order to switch on the selection field.
- ▷ Select "TPM" with the operating lever.
- ▷ Push operating lever forward.
The display changes to the Tyre pressure menu.

- ▷ Select "Info tyres" with the operating lever.
- ▷ Push operating lever forward.

Tyre selection in the "Set" menu

- ▷ Push operating lever forward in order to switch on the selection field.
- ▷ Select "TPM" with the operating lever.

- ▷ Push operating lever forward.
The display changes to the Tyre pressure menu.

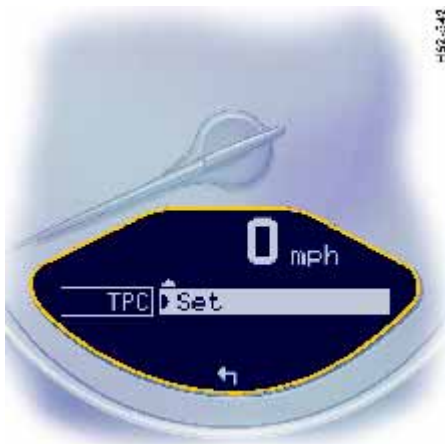

H72-576

- ▷ Select “Set” with the operating lever.



H72-577

- ▷ Push operating lever forward.
- ▷ Select desired tyre type: summer or winter.
- ▷ Push operating lever forward.
A display for confirming the selected type of tyre appears.



H72-578

- ▷ Select “Continue” and push the operating lever forward.



HAZ-518

Tyre Pressure Monitoring will re-learn the wheels only if the message “Process complete” appears after the settings have been made.

- ▷ Please observe the chapter “SYSTEM LEARNING” on page 99.

Before fitting tyres with sizes which are not stored in the on-board computer, the missing information should be supplemented in the on-board computer.

- ▷ Consult a qualified specialist workshop. We recommend a Porsche partner for this work as they have trained workshop personnel and the necessary parts and tools.
- ▷ Use only tyres approved by Porsche.

The available items in the Tyre pressure menu depend on the equipment of your vehicle. For this reason it is possible that some of the items shown here are not available on your on-board computer's display.

- ▷ Make sure that the tyre pressures correspond to the on-board computer settings. Correct the tyre pressures if necessary.
- ▷ Please observe the chapter “TYRE PRESSURES FOR COLD TYRES” on page 240.

Setting of the tyre characteristics has only been successfully completed when the message “Process complete” is displayed by the on-board computer.

- ▷ Select arrow (Back) and push the operating lever forward. The display returns to the Tyre pressure menu. The on-board computer additionally displays the message “System learning”.

Notes

The message “Process cancelled” appears if the setting process is interrupted. All entries made up to this point are lost, and the original settings remain in effect.



HAZ-518

Load (depending on equipment level)

- ▷ Push operating lever forward in order to switch on the selection field.
- ▷ Select “TPM” with the operating lever.
- ▷ Push operating lever forward. The display changes to the Tyre pressure menu.
- ▷ Select “Load” with the operating lever.



H42-521



H42-531



H42-532

- ▷ Select partial load or full load and push the operating lever forward.
- ▷ Please observe the chapter “TYRE PRESSURES FOR COLD TYRES” on page 240.
- ▷ Make sure that the tyre pressures correspond to the on-board computer settings. Correct the tyre pressures if necessary.

Tyre pressure warnings

Tyre Pressure Monitoring warns about loss in pressure in two stages, depending on the amount of pressure loss:

Stage 1 – Add air
(0.2 to 0.4 bar (3 to 6 psi) loss in pressure)

Stage 2 – Flat tyre
(from 0.4 (6 psi) loss in pressure)

Stage 1 – Add air

The pressure in the tyre is too low by 0.2 to 0.4 bar (3 to 6 psi). Driving with insufficient tyre pressure reduces the road safety of the vehicle and destroys the tyre and wheel.

- ▷ The tyre pressure warning contains the affected tyre with the tyre pressure to be added.
Correct the tyre pressure at the next opportunity.

This tyre pressure warning appears with vehicle stopped and can be acknowledged. The tyre pressure warning light in the instrument panel goes out when the tyre pressure has been corrected.

Stage 2 – Flat tyre

The pressure in the tyre has dropped by more than 0.4 bar (6 psi). This significant pressure loss is a danger to road safety.



6.27-29-

this process, Tyre Pressure Monitoring recognises the wheels and their locations.

The on-board computer displays the message “TPM is learning – monitoring not act.”.

Tyre Pressure Monitoring requires a certain amount of time to learn the wheels. During this time, the current tyre pressures are not available on the on-board-computer:

- The display of the Tyre pressure function of the on-board computer shows lines.
- The required pressures for cold tyres (20 °C (68 °F)) are indicated on the Info pressure display in the Tyre pressure menu.
- Tyre pressure warnings are issued without tyre pressure and position information (**Figure**) as soon as the vehicle's own wheels have been recognised and the tyre pressure warning light has gone out.

Position and pressure information is displayed as soon as Tyre Pressure Monitoring has assigned the wheels recognised as belonging to the vehicle to the correct wheel positions.

The wheel learning process takes place exclusively when the vehicle is being driven.

- ▷ Manually check the tyre pressure at all wheels and correct the tyre pressure to the required value.

Changing a wheel and replacing tyres

- ▷ New wheels must be fitted with radio transmitters for Tyre Pressure Monitoring. Before tyres are changed, the battery charge state of the wheel transmitters should be checked. Consult a qualified specialist workshop. We recommend a Porsche partner for this work as they have trained workshop personnel and the necessary parts and tools.

- ▷ Switch the ignition off when changing a wheel.

The tyre settings on the on-board computer must be updated after changing a wheel.

A message appears if the characteristics of the new tyres do not agree with the on-board computer settings.

- ▷ Update the on-board computer settings when the vehicle is stationary the next time.



Warning light

The warning light in the speedometer lights up:

- When a loss in pressure has been detected.
- If Tyre Pressure Monitoring is faulty
- When learning newly fitted wheels/wheel transmitters, as long as the vehicle's own wheels have not yet been recognised.

The tyre pressure warning light on the instrument panel goes out only when the cause of the fault has been rectified.

- ▷ If the tyre pressure warning has appeared on the on-board computer, stop immediately at a suitable location. Check the tyre for signs of damage. If necessary, fill in tyre sealant and set the correct tyre pressure.

This tyre pressure warning appears when driving and can be acknowledged.

The tyre pressure warning light on the instrument panel goes out when the tyre pressure has been corrected.

System learning

Tyre Pressure Monitoring begins to “learn” the wheels after a wheel change, wheel transmitter replacement or update of the tyre settings. During

No monitoring

In the event of faults, Tyre Pressure Monitoring cannot monitor the tyre pressure.

The warning light on the instrument panel lights up and a corresponding message appears on the on-board computer.

Monitoring is not active when:

- Tyre Pressure Monitoring is faulty,
 - wheel transmitters for Tyre Pressure Monitoring are missing,
 - temporarily after changing a wheel (learning phase),
 - more than four wheel transmitters are recognised,
 - there is external interference by other radio sources, e.g. wireless headphones,
 - tyre temperatures are too high.
- ▷ Please observe the chapter "WARNINGS ON THE INSTRUMENT PANEL AND THE ON-BOARD COMPUTER" on page 106.

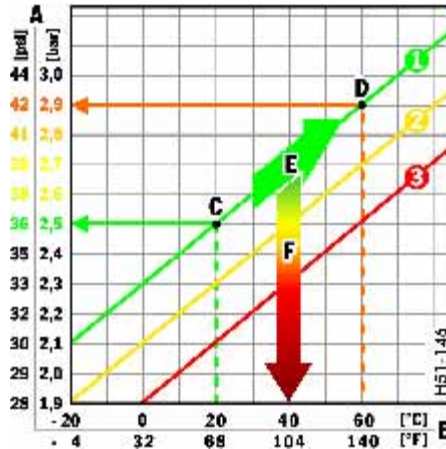

- A - Tyre pressure
- B - Tyre temperature
- C - Tyre pressure for cold tyres
- D - Tyre pressure for warm tyres
- E - Pressure increase as the result of temperature increase
- F - Pressure drop in faulty/leaky tyres

Pressure increase as the result of temperature increase

1. Required-pressure line
2. Warning stage 1 (from -0.2 bar to -0.4 bar (-3 to -6 psi))
3. Warning stage 2 (from -0.4 bar (-6 psi))

In accordance with physical principles, the air pressure changes as the temperature changes. The tyre pressure increases or decreases by around 0.1 bar (1.5 psi) for every 10 °C (18 °F) change in temperature.

Tyre Pressure Monitoring takes this relationship between tyre pressure and temperature into account.

Tyre pressure specifications

Information on tyre pressure for public roads can also be found in this Driver's Manual or on the tyre-pressure plate in the left door aperture. These values apply to cold tyres at 20 °C (68 °F).

- ▷ Only use the pressure specifications from the "Info pressure" display in the Tyre pressure menu or from the respective tyre pressure warning to correct the tyre pressure.

OIL

Display and measurement of the engine oil level

Caution!

Risk of engine damage.

- ▷ Regularly check the oil level after refuelling.
- ▷ Do not allow the oil level to fall below the minimum mark.

Conditions for measuring the oil level

1. Vehicle stationary.
2. Vehicle is level.
3. Engine must be at running temperature.
4. Engine must be idling.



Initiating oil level measurement

- ▷ Push operating lever forward in order to switch on the selection field.
- ▷ Select "OIL" with the operating lever.
- ▷ Push operating lever forward. Measurement is started.



- ▷ Allow waiting time to elapse.
- ▷ Once the measurement has been completed, you can read off the engine oil level on the segment display.



H42-500

- If the segments are filled in up to the top line, the oil level has reached the maximum mark.
- ▷ Under no circumstances add engine oil.



H52-544

- If the bottom segment is filled in, the oil level has reached the minimum mark.
- ▷ Add engine oil immediately.
- If the bottom segment flashes, the oil level has dropped to below the minimum mark.
- ▷ Add engine oil immediately.

The difference between the minimum and maximum marks on the segment display is approx. 1.5 litres.

One segment of the display corresponds to a top-up quantity of approx. 0.5 litre.

- ▷ Add engine oil if necessary. Please observe the chapter "ENGINE OIL LEVEL" on page 179. Switch off ignition before adding engine oil.

- ▷ Never add more engine oil than required to reach the maximum mark.

Failure

A failure of the oil level display is indicated by a warning message in the on-board computer.

Display "Check oil level"

The on-board computer display "Check oil level" is an additional reminder for you to check the oil level.

The display depends on the distance travelled and the operating conditions, and does not indicate whether or not the oil level is correct.

SET Basic Setting of On-Board Computer

Switching on selection field "D"

- ▷ Push operating lever forward.

Changing the basic setting of the on-board computer

- ▷ Select "SET" with the operating lever.



- ▷ Push operating lever forward.
- ▷ Select the desired function with the operating lever:



Reset

- Reset all,
Reset average consumption,
Reset average speed,
Reset trip counter

Units

- Speedometer
km - km/h,
miles - mph
- Consumption
l/100 km,
mls/gal (USA),
mpg (UK),
km/l

- Temperature
°Celsius, °Fahrenheit
- Tyre pressure bar, psi
- Engine boost pressure bar, psi

Display
(Select central line of the on-board computer)

- **Change display**
Audio information (set radio station)
Range on remaining fuel
Empty
- **Telephone info**
When Telephone information is active, incoming telephone calls are displayed on the on-board computer.



Navigation

- Integrated in the on-board computer (navigation instructions can be called on the on-board computer display)
- When turning (navigation instructions are displayed only prior to direction changes)

Basic setting

- Restore the basic setting of the on-board computer

Language

- Select language version



12/24h mode

- Select time mode:
12h (small squares on the right side of the time display for AM/PM),
24h

General information regarding the on-board computer functions

Range on remaining fuel

The range on remaining fuel is continuously recalculated during the journey based on the fuel level, current consumption and average consumption. The more the fuel level falls, the more spontaneously the display reacts. For this reason, the range on remaining fuel is not displayed if it is less than 15 kilometres (9 miles).

If the vehicle's inclination changes while driving or refuelling, incorrect range information may temporarily be given.

Note

If the tank is nearly empty and you top up with only a small quantity of fuel, this cannot be used to calculate the range on remaining fuel.

Average consumption and average speed

The displayed values are based on the distance travelled since the last reset to "zero".

You can set the starting time for a measurement before or during the trip. Switching the ignition off does not reset the measurements. It is therefore possible to collect values over long periods. Disconnecting the car battery will cause these memories to be erased.

Tyre pressure

The **Tyre pressure** function of the on-board computer displays the tyre pressures dependent on temperature in the four wheels. You can watch the tyre pressure rise and fall while driving. The display is only for information. To correct the tyre pressures, always use the displayed values from the "Info pressure" display in the Tyre pressure menu.









Engine boost pressure





The engine boost pressure is regulated by the engine control unit. The maximum boost pressure is approx. 1 bar (14.5 psi). It is, however, greatly dependent on the ambient air pressure and the fuel grade.













- ▷ Please observe the chapter "SPORT MODE" on page 46.

















Warnings on the instrument panel and the on-board computer







If a warning message appears, always refer to the corresponding chapters in the Driver's Manual. Warning messages are issued only if all measurement preconditions are met. Therefore, check all fluid levels regularly – in particular, always check the engine oil level after refuelling.















Instrument panel	On-board computer	Text display on on-board computer	Meaning/measure
		Seat belt	Driver and passengers must fasten their seat belts.
		Handbrake	Handbrake is still on.
		Ignition key not removed	
		Replace battery in ignition key	Replace the remote-control battery.
		Ignition lock faulty. Visit workshop	Consult a qualified specialist workshop.*
		Ignition lock faulty. Visit workshop now	Consult a qualified specialist workshop.*
		Relieve steering	Relieve the steering lock by moving the steering wheel to the left or right.
		Steering locked	The steering wheel lock remains engaged. Have the fault remedied at a qualified specialist workshop.*
		Lights on	Dipped beam/side light on.
		Parking light on	Left/right parking light on.







Instrument panel	On-board computer	Text display on on-board computer	Meaning/measure
		Check left/right dipped beam also applies to: front side lights, direction indicator, high beam, fog lights, side indicator light, brake light, tail light, rear fog light, reversing light, raised brake light	The reported light is faulty. Check bulb. Consult a qualified specialist workshop.*
		Daytime driving lights off	Daytime driving lights switch off when the engine is shut off. Switch on lights if necessary.
		Headlight beam adjustment faulty	Consult a qualified specialist workshop.*
		Front lid not closed	Close luggage compartment lid properly.
		Rear lid not closed	Close engine compartment lid properly.
		Rain sensor faulty	Consult a qualified specialist workshop.*
		Refill washer fluid	
		LIMIT Cannot be accepted with vehicle stopped	The current speed can only be accepted for the acoustic warning signal when the vehicle is in motion.
		LIMIT 50	Selected speed limit (e.g. 50 km/h (30 mph)) for the acoustic warning signal has been exceeded. Adjust your speed if necessary.



Instrument panel	On-board computer	Text display on on-board computer	Meaning/measure
Fuel gauge warning light		Consider remaining range	Refuel at the next opportunity.
		Check engine oil level	Start engine oil level measurement in the on-board computer. The vehicle must be horizontal and the ignition must be switched on.
		Engine oil pressure too low	Stop immediately in a suitable place, measure oil level again with the on-board computer and, if necessary, add engine oil.
Warning light, temperature gauge		Engine temperature too high	Switch engine off and let it cool. Check coolant level and, if necessary, add coolant.
Temperature gauge warning light flashes		Check coolant level	Switch engine off and let it cool. Check coolant level and, if necessary, add coolant.
		Check Engine, visit workshop	Consult a qualified specialist workshop.*
		Reduced engine power	Consult a qualified specialist workshop.*
Temperature gauge warning light flashes		Failure of engine comp. blower	Consult a qualified specialist workshop.*
		Warning Battery/generator	Stop at a safe place and switch the engine off. Do not continue driving. Have the fault remedied at a qualified specialist workshop.*
		Failure oil pressure indicator	Consult a qualified specialist workshop.*

Instrument panel	On-board computer	Text display on on-board computer	Meaning/measure
		Failure oil level indicator	Consult a qualified specialist workshop.*
		Oil temp. indicator faulty	Consult a qualified specialist workshop.*
		Failure indicator	Coolant indicator failed. Consult a qualified specialist workshop.*
		Service wear on brake pads	Have the brake pads changed immediately. Consult a qualified specialist workshop.*
		Warning Brake fluid level	Stop immediately in a suitable place. Do not continue driving. Have the fault remedied by a qualified specialist workshop.*
		Warning Brake distribution	Stop immediately in a suitable place. Do not continue driving. Have the fault remedied by a qualified specialist workshop.*
		ABS failure	Consult a qualified specialist workshop.*
		PSM off	Porsche Stability Management was switched off.
		PSM on	Porsche Stability Management was switched on.
		PSM failure	Consult a qualified specialist workshop.*
		PASM Normal/Sport	Indicator for selected PASM mode
		PASM failure	Consult a qualified specialist workshop.*

Instrument panel	On-board computer	Text display on on-board computer	Meaning/measure
		PASM indicator faulty	Consult a qualified specialist workshop.*
		Failure Sport mode	Consult a qualified specialist workshop.*
		System fault Airbag	Airbag is faulty. Consult a qualified specialist workshop.*
		Failure Spoiler control	Driving stability is impaired. Adjust your driving style. Consult a qualified specialist workshop.*
Display of selector lever position flashes		Selector lever not engaged	Tiptronic S: Selector lever can be between two positions. Engage the selector lever correctly.
		Move selector lever to P	Tiptronic S: Move selector lever to position P before withdrawing key from ignition lock.
		Apply brake	Tiptronic S: Apply the brake when starting.
		Depress clutch pedal	Manual transmission: Depress clutch pedal when starting.
		Move selector lever to P or N	Tiptronic S: The vehicle can be started only in the selector lever position P or N.
Display of selector lever position flashes		Tiptronic emergency run	Consult a qualified specialist workshop.*

Instrument panel	On-board computer	Text display on on-board computer	Meaning/measure
		Flat tyre!	Tyre Pressure Monitoring has detected a serious pressure loss. Stop in a suitable place and check tyres for damage. Fill in tyre sealant if necessary.
		Add air	Tyre Pressure Monitoring has detected a gradual pressure loss. Correct tyre pressure at the next opportunity.
		TPM is learning, monitoring not act.	Tyre Pressure Monitoring is learning the wheels on the vehicle. Tyre Pressure Monitoring is searching for the tyres and their position. During this period the current pressure specifications are not available on the on-board computer.
		TPM inactive	Tyre Pressure Monitoring is faulty. Consult a qualified specialist workshop.*
		TPM inactive Brief disturbance TPM inactive Too many wh. transm.	Tyre Pressure Monitoring is temporarily deactivated by excessive tyre temperatures (approx. 120 °C (248 °F)) or external interference (e.g. from other wheel transmitters inside the car). Once the source of the interference is removed, the system is automatically reactivated.
		Wheel change? Input new TPM settings!	Update the settings in the TPM menu of the on-board computer at the next opportunity. Wrong entries will affect the correct pressure information in the menu. The safety of your vehicle is at risk.
		TPM indicator failure	The display of Tyre Pressure Monitoring is faulty. Consult a qualified specialist workshop.*

Instrument panel	On-board computer	Text display on on-board computer	Meaning/measure
		System fault Visit workshop	Several systems may have failed. Adjust your driving style. Consult a qualified specialist workshop.*
		Failure Fuel level indicator Workshop	Consult a qualified specialist workshop.*
		Service in km/days	Service indicator Bring the vehicle in for service no later than after the distance/time shown has elapsed. However, it is the intervals in the "Guarantee and Maintenance" booklet that are decisive.
		Service now	Service indicator Have your vehicle serviced at a qualified specialist workshop.*
		Failure Convertible top ctrl	Operate convertible top in opposite direction. If there is a failure: Consult a qualified specialist workshop.*
		Convertible top not in limit pos	Fully open or close convertible top
		Opening convertible top	Message goes out in final position
		Closing convertible top	Message goes out in final position

Instrument panel	On-board computer	Text display on on-board computer	Meaning/measure
		Close rear lid	The convertible top cannot be operated with the rear lid open.
		Failure Roll-over protection	Consult a qualified specialist workshop.*

* We recommend that you use a Porsche Partner for this work since these are staffed with trained personnel and have the necessary parts.

Acknowledging warning messages

Warning messages can be deleted from the on-board computer display.

- ▷ Push the on-board computer operating lever forward.

You can recall erased warning messages in the “INFO” menu.



Light Switch



Light is switched off.

HOME

Home mode



Side light

Number plate light, instrument illumination



Dipped beam, high beam

Only with ignition on



Fog lights

Only in conjunction with side lights or dipped beam:

Pull switch to first click.
Indicator light comes on.



Rear fog light

Only in conjunction with front fog lights:

Pull switch to second click.
Indicator light comes on.

Warning gong

If the ignition key is withdrawn and the door is opened while the lights are on (not for parking light and Home mode), a **gong** warns of possible battery discharge.

In some countries, differences are possible due to provisions of law.

Note on operation

Further individual light functions (e.g. daytime driving lights) are available in vehicles with the Sport Chrono Turbo package.

Please observe the chapter "Individual Memory" in the separate PCM operating instructions.

Home mode

Switching on Home mode

▷ Move light switch to the HOME position.

For improved visibility and security when you get in and out of the car, the fog lights and the tail lights remain on for a certain period of time:

- **When you get out of the car**, the lights are turned on for approx. 30 seconds after the door is opened. The off-delay time recommences when the vehicle is locked. On vehicles with the Sport Chrono Turbo package, the PCM can be used to set the off-delay time. This setting also changes the lighting period when the vehicle is unlocked. Please observe the chapter "Individual Memory" in the separate PCM operating instructions.
- The lights are turned on for approx. 30 seconds when the vehicle **is unlocked**. The lights go out if the ignition is switched on or if you leave Home mode.

Headlight Beam Adjustment

Vehicles with Bi-Xenon headlights feature automatic headlight beam adjustment.

When the ignition is switched on, the level of the headlight beam automatically changes in accordance with the vehicle load.

The level of the headlight beam is automatically kept constant during acceleration and braking.

Checking operation

1. Switch the dipped beam on.
2. Insert ignition key and switch on ignition.
The light beam first dips all the way down and is then adapted to the vehicle load.

If this test point is not satisfied, the headlight beam adjustment system must be checked.

- ▷ Consult a qualified specialist workshop. We recommend a Porsche partner for this work as they have trained workshop personnel and the necessary parts and tools.



Direction Indicator/High Beam/ Parking Light/Headlight Flasher Stalk

Direction indicators, dipped beam and high beam are ready for operation when the ignition is on.

- 1 – Direction indicator left
- 2 – Direction indicator right

Push the stalk to the upper or lower pressure point – direction indicators flash three times

- 3 – High beam
- 4 – Headlight flasher

Stalk in centre position – dipped beam

When high beam and headlight flasher are selected, the blue indicator light in the tachometer is lit.

Parking light

The parking light can only be switched on when the ignition is switched off.

- ▷ Move the stalk up or down to switch on the right or left parking light.

Windscreen Wiper/Washer Stalk



Caution!

Risk of injury if windscreen wipers start to wipe unexpectedly, e.g. in rain sensor operation.

Risk of damage to the windscreen, wiper system and headlight washer.

- ▷ Only wipe the windscreen when sufficiently wet, otherwise it could be scratched.
- ▷ Loosen frozen wiper blades before driving off.
- ▷ Always switch off windscreen wipers in car washes to prevent them wiping unintentionally (sensor operation).
- ▷ Always switch off windscreen wipers before cleaning the windscreen to avoid unintentional operation (sensor operation).
- ▷ Do not operate the headlight washer in car washes.
- ▷ Do not operate headlight washer when it is frozen.

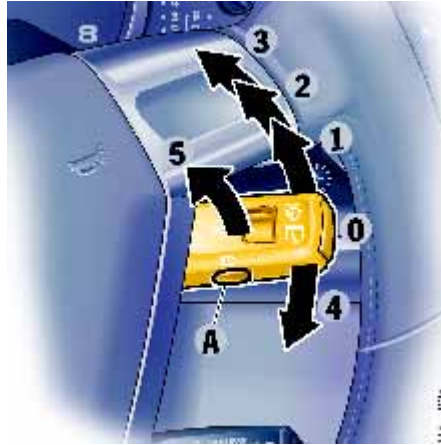

Front wiper and headlight washer system

0 – Windscreen wipers off

1 – Rain sensor operation, front windscreen wipers

Move wiper stalk upwards to the first click.

2 – Front windscreen wiper – slow

Move wiper stalk upwards to the second click.

3 – Front windscreen wiper – fast

Move wiper stalk upwards to the third click.

4 – Front windscreen wipers – one-touch operation

Move wiper stalk downwards.

The front windscreen wipers wipe once.

5 – Front windscreen wiper and washer system

Pull wiper stalk towards the steering wheel.

The washer system sprays and wipes while the stalk is pulled towards the steering wheel.

When the wiper stalk is released, a few drying wipes are performed.

A – Headlight washer system

The washer sprays only while dipped beam or high beam is switched on.

▷ Briefly push button **A** to operate headlight washer system.

▷ If heavily soiled, repeat wash.

The headlight washer system automatically sprays once for every ten times the front windscreen washer system is operated.

Note

The **front windscreen washer nozzles** are heated when the ignition is on, as a precaution against freezing.



Please observe the chapter “Individual Memory” in the separate PCM operating instructions.

Rear wiper

6 – Rear window wiper – intermittent operation

Move wiper stalk forward.

The rear window wiper wipes at preset intervals.

If a speed of 210 km/h (130 mph) is exceeded, the rear wiper is switched off automatically and is switched on again when the speed falls below 200 km/h (125 mph).

On vehicles with Sport Chrono Turbo package, further rear wiper functions can be selected via the PCM.



Rain sensor

The rain sensor on the windscreen measures the amount of rainfall (and snowfall). Wiper speed is automatically adjusted accordingly.

Switching on

- ▷ Move wiper stalk upwards to the first click.

Switching off

- ▷ Move wiper stalk to position **0**.

Should the wiper stalk already be in position **1** when starting the engine, the rain sensor remains switched off.

To switch the rain sensor on again:

- ▷ Move wiper stalk to position **0** and then to position **1** **or**
- ▷ Operate windscreen washer system **5** **or**
- ▷ Change the sensitivity of the rain sensor with four-stage switch **A**.

Switch-on is confirmed by one wipe of the windscreen.

On vehicles with the Sport Chrono Turbo package, further rain sensor functions can be selected via the PCM.

- ▷ Please observe the chapter “Individual Memory” in the separate PCM operating instructions.

Changing the sensitivity of the rain sensor

Sensitivity can be set with switch **A** in 4 stages:

- ▷ Move switch **A** upwards – high sensitivity.
The setting is confirmed by one wipe of the windscreen.
- ▷ Move switch **A** downwards – low sensitivity.

Maintenance notes

- ▷ Periodically clean the wiper blades with a window cleaner, especially after the vehicle has been washed in a car wash. We recommend Porsche window cleaner. If they are very dirty (e.g. with insect remains), they can be cleaned with a sponge or cloth.

If the wiper blades rub or squeak, this may be as a result of the following:

If the vehicle is washed in an automatic car wash, wax residues adhere to the windscreen. These wax residues can only be removed by using a concentrated window cleaner.

- ▷ Please observe the chapter “WASHER FLUID” on page 185.

Please contact your Porsche partner for further information.

If the wiper blades are damaged or worn out:

- ▷ Replace wiper blades as soon as possible.



- A - Cruise control readiness on/off
- 1 - +SPEED/SET (accelerate/store)
- 2 - -SPEED (decelerate)
- 3 - OFF (interrupt)
- 4 - RESUME (return to set speed)

Cruise Control

The cruise control maintains any selected speed between 30 and 240 km/h (20 and 150 mph) without you having to use the accelerator. The cruise control is operated with the lever on the steering wheel.

Vehicles with Tiptronic

Additional downshifts are carried out to help maintain the pre-selected speed (especially when driving downhill).



Warning!

Risk of accident in heavy traffic, on twisting roads or under unfavourable road conditions (e.g. wintry or wet conditions or varying road surfaces etc.).

- ▷ Do not use the cruise control in these conditions.

Switching cruise control readiness on

- ▷ Press button **A** on the cruise control lever.



The green indicator light on the speedometer now indicates readiness.

Maintaining and storing speed

- ▷ Bring the vehicle to the desired speed with the accelerator.
- ▷ Then briefly push the operating lever forward (position **1**).

Accelerating (e.g. to overtake)

Option 1

- ▷ Increase the speed as usual with the accelerator.
- When you ease off the accelerator, the previously saved value is again set.

Option 2

- ▷ Push operating lever forward (position **1**) until the desired speed is reached.
- The speed reached is maintained and stored when the lever is released.

Option 3

- ▷ Push operating lever forwards briefly (position **1**) (a maximum of 10 times).
- The speed is increased by 2 km/h (1 mph) each time.

Note on operation

Cruise control operation is automatically interrupted if the speed is increased by more than approx. 25 km/h (16 mph) for longer than 20 seconds.

Decelerating

Option 1

- ▷ Pull operating lever towards the steering wheel (position **2**) until the desired speed is reached. The speed reached is maintained and stored when the lever is released.

Option 2

- ▷ Briefly move lever towards the steering wheel (position **2**) (a maximum of 10 times). The speed is reduced by 2 km/h (1 mph) each time.

Vehicles with Tiptronic

Additional downshifts are carried out to improve deceleration (especially when driving downhill).

Interrupting cruise control operation

- ▷ Pull operating lever downwards briefly (position **3**) **or**
- ▷ Operate brake or clutch pedal **or**
- ▷ Switch Tiptronic transmission to selector lever position **N**.
- ▷ Please observe the chapter "TIPTRONIC S" on page 143.

The speed driven at before the interruption remains stored in the memory.

Cruise control operation is interrupted automatically:

- If the set vehicle speed is exceeded by more than approx. 25 km/h (16 mph) for longer than 20 seconds.
- If the actual vehicle speed falls to approx. 10 km/h (6 mph) below the set vehicle speed for longer than 5 seconds (upward slopes).
- For PSM control operations.

Resuming the stored speed

- ▷ Briefly push operating lever upwards (position **4**).
The cruise control accelerates/decelerates the vehicle to the stored speed.

The stored speed should only be recalled when traffic conditions and the road surface so permit.

Switching cruise control readiness off

- ▷ Press knob **A** on the cruise control lever – the green readiness light in the speedometer goes out.

The memory is cleared when the vehicle is parked and the ignition switched off.

Tip on driving

On upward or downward slopes, the set speed cannot always be maintained by the cruise control.

- ▷ To obtain sufficient engine braking or a better engine-speed range, you therefore have to change down to a lower gear.



Hazard Warning Lights

The hazard warning lights are ready for use regardless of the ignition lock position.

Switching on and off

- ▷ Press button on the instrument panel.
All direction indicator lights and the indicator light in the switch flash with the same rhythm.

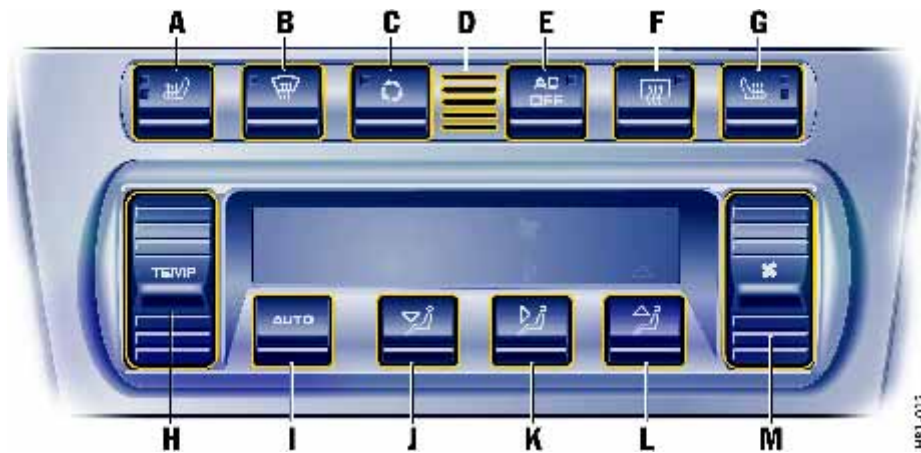

- A** - Seat heating, left
- B** - Defrosting the windscreen
- C** - Circulating-air button
- D** - Temperature sensor
- E** - AC OFF button (air-conditioning compressor on/off)
- F** - Heated rear window
- G** - Seat heating, right
- H** - Temperature button
- I** - AUTO button (automatic mode)
- J** - Air distribution to footwell
- K** - Air distribution to central and side vents
- L** - Air distribution to windscreen
- M** - Blower speed button

Note

If the preselected temperature is changed, the blower speed can increase automatically in automatic mode. The desired temperature is reached more quickly this way.

Sensors

- To avoid affecting the performance of the air-conditioning system:
 - ▷ Do not cover the sun sensor on the instrument panel or the temperature sensor **D**.

Automatic Air-Conditioning System

The automatic air-conditioning system controls the preselected interior temperature completely automatically. If necessary, the automatic system can be manually influenced.

Automatic mode

- ▷ Press AUTO button **I**. **AUTO** will appear on the display panel. Air quantity and distribution are automatically controlled and variations are compensated.

All automatic setting functions can be individually changed.

This setting is retained until the appropriate function button is pressed again or the AUTO button is pressed.

Setting temperature

- ▷ Press button **H** upwards or downwards respectively.

To suit personal comfort, the interior temperature can be adjusted between 16 °C (61 °F) and 29.5 °C (85 °F).

Recommendation: 22 °C (72 °F).

If “LO” or “HI” appears on the display, the system is operating at maximum cooling or heating power. Automatic control is no longer active.



Defrosting the windscreen

- ▷ Press button **B** (switch on or off).
The windscreen is demisted or defrosted as quickly as possible.
Air flows to the windscreen only.
The light-emitting diode in the button lights up.

AC OFF – switching the air-conditioning compressor on and off

At temperatures below approx. 3 °C (37 °F), the air conditioning compressor switches off automatically and cannot be switched on, even manually.

Whenever outside temperatures exceed approx. 3 °C (37 °F), the air-conditioning compressor is always switched on in automatic mode.

The compressor can be switched off to save fuel, but control comfort is then limited:

- ▷ Press AC OFF button **E**.
The compressor is switched off.
The light-emitting diode in the button lights up.
- ▷ If the interior temperature is too high, switch compressor back on or press AUTO button.

To dry incoming air in damp weather, do not switch off the air-conditioning compressor.

This prevents misting of windows.



Adjusting blower speed

- ▷ Press button **M** upwards or downwards respectively.
The preset blower speed is increased or decreased.

The speed stages are indicated by a bar display.

If the button is pressed downwards at the lowest blower stage, the blower and automatic control are switched off. "OFF" will appear on the display field.

Pressing the button upwards or pressing the AUTO button switches the blower and automatic control back on again.



Circulating-air mode

The outside-air supply is interrupted and only the inside air is circulated.



Warning!

Risk of accident due to hampered vision. In circulating-air mode, the windows may mist up.

- ▷ Only select circulating-air mode for short periods.
- ▷ If the windows mist up, switch circulating-air mode off immediately by pressing the circulating-air button again and select the "Defrost windscreen" function.

Switching circulating-air mode on or off

- ▷ Press button **C**.
The light-emitting diode in the button lights up.

Above approx. 3 °C (37 °F)

If the air-conditioning compressor was off, it switches on automatically. The duration of circulating-air mode is not limited.

Below approx. 3°C (37 °F)

The air-conditioning compressor is switched off. Circulating-air mode is automatically ended after approx. 3 minutes.

Air distribution

The individual air distributions can be combined as desired.

Recommended setting in summer:
Air distribution to central and side vents.

Recommended setting in winter:
Air distribution to footwell and windscreen.



Air distribution to footwell

- ▷ Press button **J**.
The air flows to the footwell.
The selection appears on the display panel.



Air distribution to central and side vents

- ▷ Press button **K**.
The air flows from the central and side vents.
Vents must be open.
The selection appears on the display panel.



Air distribution to windscreen

- ▷ Press button **L**.
The air flows to the windscreen.
The selection appears on the display panel.

Note on operation

- ▷ On vehicles with the Sport Chrono Turbo package, individual air conditioning settings can be stored on your vehicle key. Please observe the chapter "Individual Memory" in the separate PCM operating instructions.

Information on air-conditioning compressor

- Can switch off briefly if engine is under an extreme load to ensure sufficient engine cooling.
- Switches off automatically at temperatures below approx. 3 °C (37 °F) and cannot be switched on, even manually.
- Operates most effectively with windows closed.
If the vehicle has been in the sun for a long time, it is a good idea to ventilate the interior briefly with the windows open.
- Depending on the outside temperature and humidity, condensation can drip from the evaporator and form a pool under the vehicle. This is normal and not a sign of leakage.
- If uncooled air flows out when the lowest temperature has been set, switch off the air-conditioning compressor and have the fault repaired.
Consult a qualified specialist workshop. We recommend a Porsche partner for this work as they have trained workshop personnel and the necessary parts and tools.



A - Continuous opening and closing
B - Setting vent direction

Central and Side Vents

⊙ Opening vents

- ▷ Rotate thumb wheel upward.

● Closing vents

- ▷ Rotate thumb wheel downward.

Changing air flow direction

- ▷ Swivel vent vanes in the desired direction.

Outside air or conditioned air can be delivered from all vents depending on the air-distribution setting.

Fresh-air intake

In order to ensure unhindered air intake:

- ▷ Keep the fresh-air intake between the windscreen and the luggage compartment lid free from snow, ice and leaves.



Heated Rear Window/Door Mirror Heating

The heated rear window/door mirror heating is ready for operation when the ignition is on.

Switching on

- ▷ Press button.
The light-emitting diode in the button lights up.
- After approx. 15 minutes, the heater switches off automatically.
The heating can be switched back on again by pressing the switch again.

Switching off

- ▷ Press button.
The light-emitting diode in the button goes out.

Cupholder

(holder for drinks cans and cups)

- ▷ Keep the cupholder closed while driving.

Warning!

Risk of scalding or damage due to spilling drinks.

- ▷ Only use containers which fit.
- ▷ Do not put overfilled containers in the cupholder.
- ▷ Do not use for hot drinks.



Extending cupholder

- ▷ Press the panel.
The panel opens.

- ▷ Press the symbol for the respective cupholder.
- ▷ Close panel in the middle.

The cupholders can be pulled out to hold larger containers.



Closing cupholder

- ▷ Push cupholder drawer in.
- ▷ Open panel in the middle.
- ▷ Close and engage the cupholder.
- ▷ Close panel in the middle.

Pulling cupholder out

- ▷ Pull out holder (**arrow**).
- ▷ Insert container.
- ▷ Carefully slide holder inwards to adjust it to the container size.

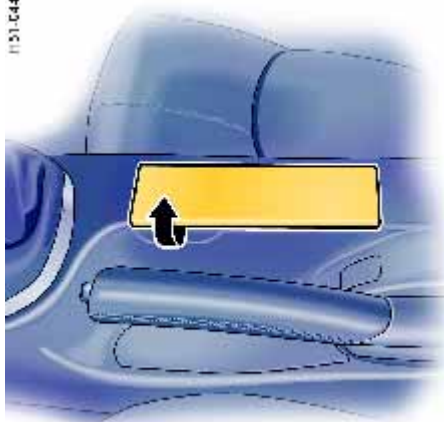

Ashtray

Opening

- ▷ Open ashtray lid.

Emptying

- ▷ Open ashtray and carefully pull out ash insert.
- ▷ Leave ashtray lid open.
Push in ash insert.



Cigarette Lighter

The cigarette lighter is ready for use regardless of the ignition lock position.



Warning!

Risk of fire and burning.

- ▷ Do not leave children in the vehicle unattended.
- ▷ Only hold the heated lighter by the knob.

Heating lighter

- ▷ Open ashtray lid.
- ▷ Press lighter into the receptacle.
When the element is red hot the lighter jumps back to its initial position.

Note on operation

The lighter receptacle should not be used for electrical accessories (except for the tyre filling compressor).

- ▷ Please observe the chapter "SOCKETS" on page 210.

Storage

Warning!

Danger of injury during braking, rapid direction changes or in an accident.

- ▷ Do not carry items of luggage or objects in the passenger compartment unsecured.
 - ▷ Do not transport any heavy objects in the oddments trays.
-

Storage options

- in the doors,
- in the door sill next to the passenger's seat,
- in the centre console,
- behind the rear seat backrests (only with the convertible top closed on the Cabriolet; when opening the convertible top there should not be any objects in the area behind the rear seats – risk of damage),
- oddments tray with coin holder between seats,
- glove compartment with CD and pen holder,
- clothes hook on the roof frame,
- clothes hook on back of front backrests (depending on vehicle equipment),
- enlarged storage space by folding the rear seat backrests forward.



Oddments tray between the seats

Opening

- ▷ Press release button and lift the lid. There is a coin holder and socket in the forward part of the oddments tray.
- ▷ Please observe the chapter “SOCKETS” on page 210.

Glove compartment



Warning!

Danger of injury by the glove compartment lid in case of an accident.

- ▷ Keep the glove compartment lid closed while driving.

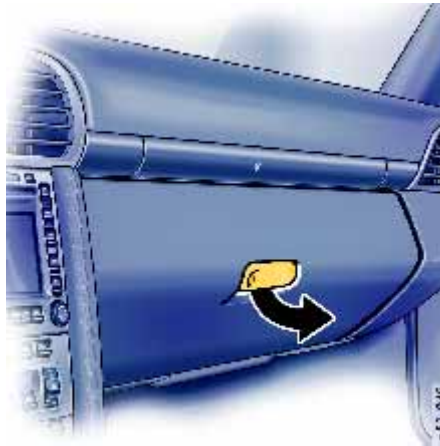

Opening

- ▷ Pull the catch and open the lid.

Locking

- ▷ Lock the catch to secure the contents against unauthorised access.

CD holder

Occupied drawers are indicated by a red window.

Opening drawers

- ▷ Push the button of the drawer you wish to open.

Closing drawers

- ▷ Fold up CD drawer and close until it engages.

Pen holder

A pen can be clipped in on the right side of the CD holder.

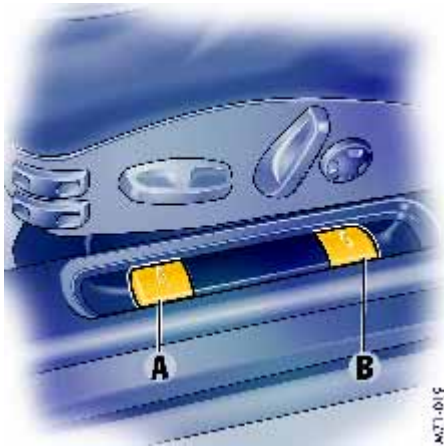

A - Opening the luggage compartment lid
B - Opening the engine compartment lid

Luggage Compartment Lid and Engine Compartment Lid

Unlocking

- ▷ Operate the appropriate pull-button next to the driver's seat.
The luggage compartment or engine compartment is illuminated when the respective lid is open.
- ▷ Please observe the chapter "LOAD SWITCH-OFF AFTER 2 HOURS OR 7 DAYS" on page 211.

The luggage compartment lid can also be unlocked with the radio remote control.

- ▷ Please observe the chapter "KEYS" on page 10.

Note

If the vehicle battery is discharged, the luggage compartment lid can only be opened by connecting an external power source.

- ▷ Please observe the chapter "ELECTRICAL SYSTEM" on page 210.
or the description inside the fuse box lid.



Warning message

A warning light in the instrument panel comes on if the lids are not completely closed.

- ▷ Fully close the lid.



Closing luggage compartment lid and engine compartment lid

- ▷ Lower the lid and close it.
- ▷ Push the lid closed with the palm of your hand in the area of the lock. Check that the lid has correctly engaged in the lock.

Opening luggage compartment lid



Risk of damage to luggage compartment lid or windscreen wipers.

- ▷ Make sure that the windscreen wipers are not pulled out forwards when opening the luggage compartment lid.
-
- ▷ Raise lid slightly and unlatch the safety catch with the lever (**arrow**).



Luggage Compartment

The position of the components in the luggage compartment depends on the country equipment and can vary from what is shown in the Driver's Manual.

DVD navigation

The drive for DVD navigation can be found behind the access cover **A**.

Opening

- ▷ Open access cover **A** using the handhold.

H01 72/6

Caution!

Risk of damage.

- ▷ Do not store any objects behind the access cover.

Warning triangle

The warning triangle can be secured to the front of the luggage compartment.

- ▷ Before removing the warning triangle, disengage the rubber ring mount (**Figure**).

First aid kit

The mounting strap of the first aid kit can be fixed on the right side (direction of travel) of the luggage compartment rear wall.

Tyre sealant

The tyre sealant is located behind the access cover **B**.

- ▷ Open access cover **B** using the opening.

Tools

The tools are located under the floor plate of the luggage compartment.

- ▷ Lift the floor plate at the opening or at the warning triangle and take out.

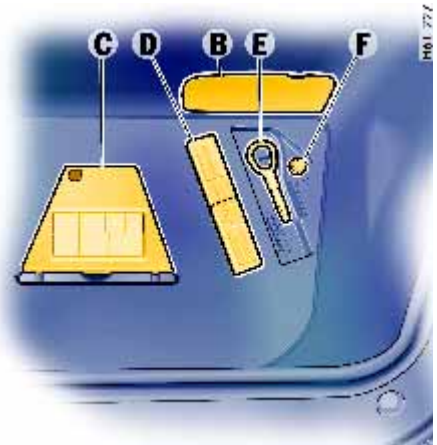

- B** - Access cover for tyre sealant
- C** - Tyre filling compressor
- D** - Tool kit
- E** - Towing lug
- F** - Adapter for security wheel bolts

H01 72/7

Car Telephones and 2-Way Radios

- ▷ Read the operating instructions of the telephone manufacturer before putting a telephone into operation.
- ▷ Please observe the applicable national regulations regarding telephone calls during driving.

Safety notes!

- ▷ For reasons of road safety, only telephone using the hands-free unit.
- ▷ To prevent any possible risk to health: Use telephones or 2-way radios with integral radio antennas in the vehicle only if an external antenna is connected.

Installation of mobile communications systems (car telephone, 2-way radio, etc.) requires approval and should be performed only according to Porsche installation specifications in a specialist workshop.

The transmission power must not exceed 10 W.

The devices must possess a type approval for your vehicle and have an **“e” symbol**.

If you should require equipment with transmission power values greater than 10 W, please consult a qualified specialist workshop for this purpose. The workshop will be familiar with the technical requirements for installing devices of this kind.

Incorrectly installed equipment or antennas as well as telephones and 2-way radios without external antenna may interfere with the vehicle electronics as a result of radio transmission. Therefore, use telephones or 2-way radios only with connected external antenna.



Hands-free microphone

Hands-free microphones installed at the factory must be adapted to the type of telephone in use. Your Porsche partner will be pleased to advise you.

Reception quality

The reception quality of your telephone changes continuously while you drive. Interference from buildings, terrain and the weather is unavoidable. Comprehensibility can be adversely affected by external noise (e.g. engine and wind noise), particularly when hands-free equipment is used.

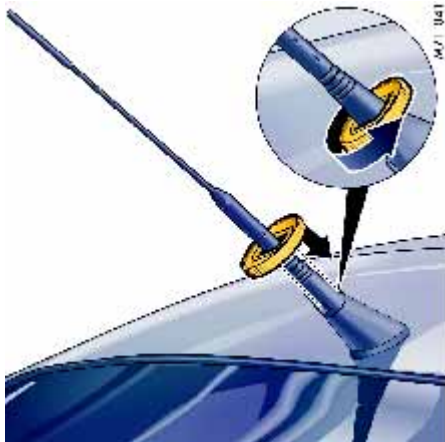

Antenna

Always unscrew the antenna before putting your car through a car wash.

On the Cabriolet, the antenna is mounted on the front right wing.

Porsche Communication Management (PCM)

- ▷ Refer to the separate operating instructions before putting the PCM into operation.

The reception conditions for the radio module integrated in the PCM change continuously as you drive. Interference from buildings, terrain and the weather is unavoidable.

FM stereo reception is particularly susceptible to varying reception conditions.

Electronic accessories should only be retrofitted after purchasing vehicle by a qualified specialist workshop.

Accessories which have not been tested and approved by Porsche may impair radio reception.

Navigation

When put into operation for the first time, a distance of approx. 50 km (30 miles) must be driven in order for the navigation system to complete the process of fine calibration. The same applies when the tyres are changed (e.g. summer/winter tyres) or new tyres fitted. Full location accuracy is not yet achieved during the fine-calibration process.

If the vehicle has been transported (e.g. ferry, car train), the system may take a few minutes to determine the current location after it has been switched on.

A large amount of tyre slip (e.g. spinning wheels on snow) may result in temporarily inaccurate navigation.

When the battery has been disconnected, it may take up to 15 minutes before the navigation system is operational again.

- ▷ Please observe the chapter “LOAD SWITCH-OFF AFTER 2 HOURS OR 7 DAYS” on page 211.

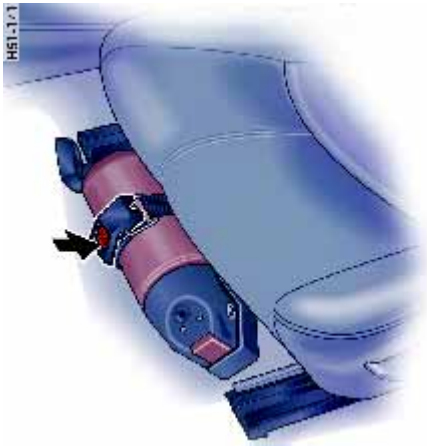

Fire Extinguisher

In cars with a fire extinguisher, the extinguisher is fitted to the front of the driver's seat.

Taking out fire extinguisher

1. Hold fire extinguisher with one hand and press the PRESS button on the fastening strap with the other hand (**arrow**).
2. Remove fire extinguisher from mounting.

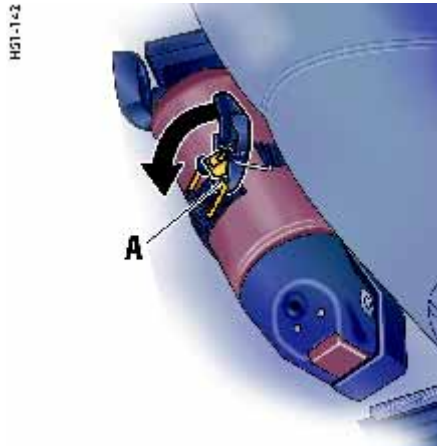

Inserting fire extinguisher

1. Place fire extinguisher in the mounting.
2. Engage fastening strap lug **A** in the tensioning clasp and close tensioning clasp (**arrow**).

Notes

- ▷ Pay attention to the final inspection date on the fire extinguisher.
If the fire extinguisher is used after its inspection interval has elapsed, it may not function properly.
- ▷ Follow the operating instructions on the fire extinguisher.
- ▷ The fire extinguisher should be checked for operation by a specialist workshop every 1-2 years.
- ▷ After use, have the fire extinguisher refilled.

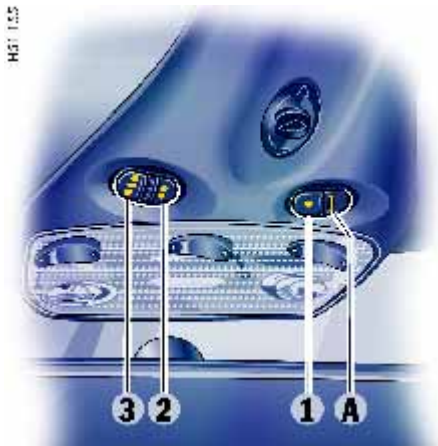

1, 2, 3 - Programmable buttons
A - Light-emitting diode for status identification

HomeLink

The programmable HomeLink replaces up to three original hand-held transmitters used to operate various devices (e.g. garage door, gate to the property, alarm system).

You can program buttons **1 to 3** with a frequency of an original handheld transmitter.

Warning!

Risk of accident when using the HomeLink if persons, animals or objects are within the range of movement of the equipment that is being operated.

- ▷ When using the HomeLink, ensure that no persons, animals or objects are within the range of movement of the equipment that is being operated.
- ▷ Observe the safety notes for the original hand-held transmitter.

Preconditions for operating and programming the HomeLink:

- Ignition is switched on.
- Fog lights are switched off.

To operate the respective device:

- ▷ Press the appropriate button (**1, 2 or 3**). Light-emitting diode **A** lights up during signal transfer.

Notes on operation

- ▷ Always use the HomeLink opener in the direction of travel. Otherwise, range restrictions cannot be ruled out.
- ▷ Before selling the vehicle, delete the programmed signals of the HomeLink.
- ▷ Please read the instructions for the original hand-held transmitter to find out whether the original transmitter is equipped with fixed or changeable code.



Allocating signals to the buttons

- ▷ Please follow the operating instructions for the original hand-held transmitter.

Prior to programming the HomeLink for the first time

The following process deletes the standard codes set at the factory. Do not repeat the process if you program further buttons.

- ▷ Keep the two outer buttons **1 and 3** depressed for approx. 20 seconds until light-emitting diode **A** begins to flash quickly. All programmed signals of buttons **1 to 3** are deleted.

HomeLink with fixed code system

1. Press the desired button until the light-emitting diode begins to flash slowly. You then have approx. 5 minutes to perform steps 2 and 3.
2. Hold the original hand-held transmitter approx. 0 to 30 cm in front of the marked position (illustration) on the vehicle.
3. Press the transmit button on the original hand-held transmitter until the fog lights flash three times (up to approx. 45 seconds).
4. Repeat steps 1 to 3 to allocate other buttons.

Note

Several attempts with different distances between the vehicle and the original hand-held transmitter might be necessary.

The fog lights will flash once if the 5 minutes have been exceeded. Programming must be repeated from the beginning in this case.

HomeLink with changeable code system

1. Allocate the required button as for systems with a fixed code (steps 1 to 3).
2. To synchronise the system: Press the programming button on the receiver for the garage door drive. Afterwards, you usually have approx. 30 seconds to initiate step 3.
3. Press the allocated HomeLink button twice. (With some devices, the button to be allocated must be pressed a third time in order to complete the setting process.)
4. Repeat the programming steps to allocate other buttons.

Note

- ▷ Please consult a Porsche partner if you have not been able to successfully allocate signals for the garage door opener to the buttons even though you have carefully followed the instructions in this chapter and the operating instructions for the original hand-held transmitter. Your Porsche Partner has a list of all garage door opener signals that can be adapted.

To reprogram a single button:

1. Press the desired button until the light-emitting diode begins to flash slowly (approx. 20 seconds). You then have approx. 5 minutes to perform steps 2 and 3.
2. Hold the original hand-held transmitter approx. 0 to 30 cm in front of the marked position (illustration) on the vehicle.
3. Press the transmit button on the original hand-held transmitter until the fog lights flash three times (up to approx. 45 seconds).
4. Repeat steps 1 to 3 to allocate other buttons.

Note

Several attempts with different distances between the vehicle and the hand-held transmitter might be necessary.

The fog lights will flash once if the 5 minutes have been exceeded. Programming must be repeated from the beginning in this case.

Deleting programmed signals of the HomeLink

(e.g. when selling the vehicle)

- ▷ Keep the two outer buttons **1 and 3** depressed for approx. 20 seconds until light-emitting diode **A** begins to flash quickly. All programmed signals of buttons **1 to 3** are deleted.

Shifting Gears

Manual Transmission, Clutch	142
Tiptronic S.....	143



Manual Transmission, Clutch

Warning!

Risk of accident.

- ▷ Do not obstruct the pedal travel with floor mats or other objects.
Non-skid floor mats of the correct size are available at your Porsche partner.

The positions of the gears are shown on the shift diagram on the gearshift lever.

- ▷ When shifting gears, always ensure that the clutch pedal is fully depressed and the gear has fully engaged.
- ▷ Select reverse only when vehicle is stationary.
- ▷ Select an appropriately low gear on upward and downward slopes.
This will ensure optimum use of engine power and engine braking.

When reverse gear is selected and the ignition is on, the reversing lights are lit.

Permitted engine speed

- ▷ You should change into a higher gear before the needle reaches the red mark on the tachometer, or ease off the accelerator.

If the red zone is reached during acceleration, fuel feed is interrupted.

Caution!

Risk of engine damage (overrevving) when shifting down to a lower gear.

- ▷ Take care not to exceed the maximum permitted engine speed when shifting down.

Tiptronic S

The Porsche Tiptronic is a five-speed transmission with an “automatic” and a “manual” selection mode.

In **automatic selection mode** (selector lever position **D**), gear changing is automatic.

You can change temporarily from automatic to manual mode using the rocker switches on the steering wheel.

In **manual selection mode** (selector lever position **M**), you change gear using the rocker switches on the steering wheel.

You can change between selector lever position **D** and **M** as you wish while driving.

Note

- ▷ Take care not to operate the rocker switches on the steering wheel inadvertently in either automatic or manual mode, thereby triggering undesired gear changes.



Changing the selector lever position

The selector lever is locked when the ignition is switched off.

When the ignition is switched on, the selector lever can be moved from position **P** and **N** only when the release button is pressed, and when the brake pedal is pressed.

Release button

The release button (**arrow**) in the selector lever prevents the gear from being changed unintentionally.

The release button must be pressed when shifting to position **R** or **P**.

Starting

The engine can be started only if the brake pedal is depressed and the selector lever is in position **P** or **N**.

Moving off

- ▷ Only select the desired position for moving off (**D**, **M** or **R**) when the engine is idling and the brake pedal is depressed.
- ▷ Since the vehicle creeps when in gear, do not release the brake until you want to move off.
- ▷ After selecting a gear, do not accelerate until you can feel that the gear is engaged.

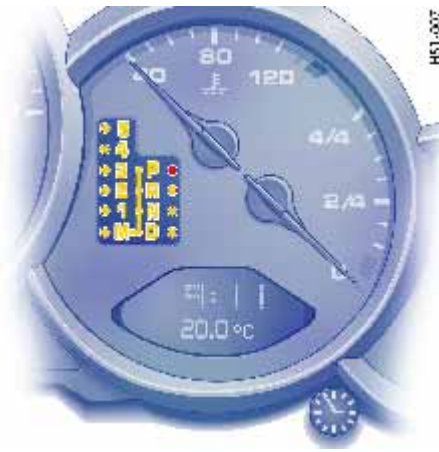

Indicator for selector lever position and engaged gear

When the engine is running, the selector lever position and engaged gear are indicated.

If the selector lever is between two positions:

- The corresponding selector lever position in the instrument cluster flashes for two seconds **and**
- The warning “Selector lever not engaged” appears on the on-board computer.
- ▷ Engage the selector lever correctly.
- The selector lever position is displayed immediately after the correct position has been detected.
- The current gear is shown after a brief detection period.

If there is a fault in the transmission:

- The **4th gear** display flashes.
- The warning “Tiptronic emergency run” appears on the on-board computer. Please observe the chapter “REDUCED DRIVING PROGRAMME” on page 148.
- ▷ Have the fault repaired immediately. Consult a qualified specialist workshop. We recommend a Porsche partner for this work as they have trained workshop personnel and the necessary parts and tools.

Selector lever positions

P – Parking lock

- ▷ Engage parking lock only when vehicle is stationary.
- ▷ Engage parking lock **after** applying the handbrake and release it **before** releasing the handbrake.

The **ignition key** can be withdrawn only in selector lever position **P**.

R – Reverse gear

- ▷ Select only if car is stationary and the brake is applied.

N – Neutral

Selector lever position **N** must be selected for towing or in car washes, for example.

- ▷ Only select the desired position for moving off (**D**, **M** or **R**) when the engine is idling and the brake pedal is depressed.

D - Automatic selection mode

Select position **D** for “normal” driving. The gears are shifted automatically according to the accelerator position and speed.

Depending on the way the vehicle is driven and on the resistance (e.g. uphill), the gear-changing points are shifted towards higher or lower engine-speed ranges.

The accelerator position, driving speed, engine speed, longitudinal and lateral acceleration and the road profile all have an influence on the gear-changing characteristic.

Unwanted upward shifts, e.g. before bends, are prevented by swiftly releasing the accelerator pedal.

Depending on lateral acceleration, upward changes on bends are not made until the engine-speed limit is reached.

Under braking, and depending on the amount of deceleration, the Tiptronic changes down earlier. For subsequent cornering, the right gear is engaged when pressure is applied to the brakes before the bend. The bend is taken in the right gear, and when you accelerate out of the bend you do not have to change down.

Sport mode switched on

- ▷ Please observe the chapter “SPORT MODE” on page 46.

If the Sport mode programme is switched on, Tiptronic switches to a sporty gear-changing map and shortens the shifting times. Deceleration downshifts are commenced earlier. Downshifts are already carried out in the case of slight decelerations, even at higher engine speeds.

Condition:

The engine speed of 3300 rpm must be exceeded once for at least 2 seconds.

Moving off

In **2nd gear**, the vehicle moves off with the throttle only slightly open. Move off in **1st gear** with the throttle open wider or when the engine is cold.

When the Sport mode is active the vehicle moves off in **1st gear**.

Condition:

The engine speed of 3300 rpm must be exceeded once for at least 2 seconds.

- ▷ Please observe the chapter “SPORT MODE” on page 46.

Shifting gears on the steering wheel

With the rocker switches on the steering wheel, you can change temporarily from automatic selection mode **D** to manual mode **M**.

For example:

- Shifting down before bends and on entering built-up areas.
- Shifting down on downward slopes (engine braking).
- Shifting down for brief spurts of acceleration.
- Selecting 1st gear for moving off.

Manual selection mode remains engaged:

- for cornering (depending on the lateral acceleration) and overrunning,
- when the vehicle is stationary (e.g. at a junction).

The system leaves manual selection mode:

- automatically after approx. 8 seconds (unless cornering or overrunning),
- if you depress the accelerator to kickdown,
- after moving off.

Temporary change-down

Conditions:

Speed is higher than approx. 54 km/h (33 mph).

- ▷ Rapid acceleration.
The Tiptronic changes temporarily to the sportiest gear-changing map, i.e. to the highest possible gear-changing points. Correspondingly, the transmission shifts down immediately by one or two gears.

Ending the function:

- ▷ Release the accelerator markedly (by approx. 25 %).

Kickdown

The kickdown function is active in selector lever position **D**, even if you temporarily change to manual mode **M** using the rocker switches on the steering wheel.

- ▷ For optimum acceleration, e.g. when overtaking, depress the accelerator pedal beyond the full-throttle point (kickdown).

The transmission shifts down depending on the speed of travel and engine speed.

Upward shifts occur at the highest possible engine speeds.

These gear-changing speeds remain active until the accelerator is released to approx. 80 % of the full-throttle position.



H5 - 005

M - Manual selection mode

The currently selected gear is retained when you change from **D** to **M**.

If you change from **M** to **D**, the gear-changing map suitable for your current driving style is selected and the appropriate gear is selected.

Kickdown downshifts are not active in selector position "M".

Therefore, when accelerating (e.g. to overtake), you must change down manually.

Two rocker switches in the upper steering-wheel spokes let you comfortably and reliably select the five forward gears.

Shifting up

- ▷ Press upper part (+) of a rocker switch.

Shifting down

- ▷ Press lower part (-) of a rocker switch.

Depending on driving speed and engine speed, you can shift up or down at any time. Gear changes which would exceed the upper or lower engine-speed limit are not executed by the controller.

You can change down two gears by quickly pressing the rocker switches twice.

If the engine-speed limit is reached, an automatic upward shift is performed or, just before idling speed is reached, a downward shift is performed.

Select an appropriately low gear on upward and downward slopes. This will ensure optimum use of engine power and engine braking.

PSM switched off and/or Sport mode switched on

- ▷ Please observe the chapter “SWITCHING OFF PSM” on page 49.
- ▷ Please observe the chapter “SPORT MODE” on page 46.

If the PSM is switched off and/or Sport mode is switched on, an automatic upshift does not occur when the engine speed limit is reached.

Cancelling upshift suppression

The restriction can be cancelled for one gear change by depressing the accelerator to kickdown. If, for example, the engine speed limit is reached during overtaking and the automatic upshift does not occur, the transmission in this case shifts up as a result of kickdown operation.

- ▷ Depress the accelerator pedal beyond the full-throttle point (kickdown).

Manual mode failure

If manual mode fails, the control electronics switch to automatic mode. In this event, the instrument cluster will display selector lever position **D**.

- ▷ Have the fault remedied. Consult a qualified specialist workshop. We recommend a Porsche partner for this work as they have trained workshop personnel and the necessary parts and tools.

Stopping

- ▷ For a brief stop (e.g. at a traffic light), leave the selector lever in drive position and hold the vehicle with the brake pedal.
- ▷ For a longer stop with the engine running, select position **N** (neutral) and hold vehicle in position with the foot brake. Select lever position **D** only when the brake pedal is depressed.
- ▷ Do not hold the car on a slope using the accelerator. Use the brake pedal or the handbrake instead.
- ▷ Before leaving the vehicle, always apply the handbrake and move the selector lever to position **P**.

Parking

- ▷ Go easy on the accelerator!
- ▷ When parking or manoeuvring in a small space, control the speed by careful use of the footbrake.

Driving in winter

In wintry road conditions it is advisable to take steep inclines in manual mode. This prevents the occurrence of gear changes that could cause wheelspin.

Tow-starting, towing

- ▷ Please observe the chapter "TOWING AND TOW-STARTING" on page 231.

Reduced driving programme

A transmission fault is indicated by the following symptoms:

- The **4th gear** display on the instrument cluster flashes.
- The warning "Tiptronic emergency run" appears on the on-board computer.
- The transmission no longer shifts.

Warning!

Risk of accident and damage.
Reverse-lock monitoring does not function in the reduced driving programme.

- ▷ Do not select position **R** while driving.

Proceed as follows in the event of a transmission fault:

1. Stop in a safe place.
2. Move selector lever to position **P**, switch the ignition off and wait for 10 seconds.
3. Start the engine. 2nd gear in selector position **D** and reverse gear **R** are now available.
4. Have the fault remedied immediately. Consult a qualified specialist workshop. We recommend a Porsche partner for this work as they have trained workshop personnel and the necessary parts and tools.

Mobile Roofs

Sliding/Lifting Roof.....	150
Convertible Top.....	154
Windstop	164
Hardtop.....	168
Roof Transport System.....	174

Sliding/Lifting Roof

Warning!

Risk of injury when operating or automatically closing the sliding/lifting roof.

- ▷ Take care to ensure that nobody can be injured when the sliding/lifting roof is operated.
- ▷ Always withdraw the ignition key when leaving the vehicle. Uninformed persons (children) could injure themselves by operating the sliding/lifting roof.
- ▷ In case of danger, release the button immediately and operate the sliding/lifting roof in the opposite direction.

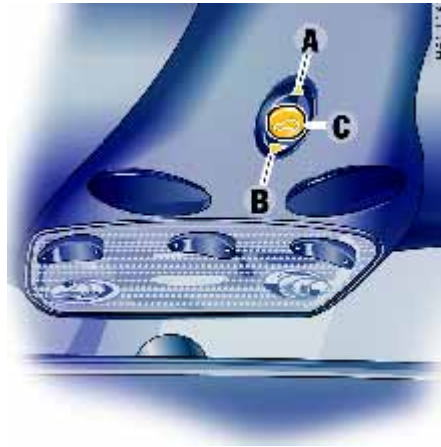

A - Opening the sliding/lifting roof

- ▷ Press rear of rocker switch **A** until the sliding/lifting roof has reached the desired position.

One-touch operation

- ▷ Briefly press rear of rocker switch **A**. Sliding/lifting roof opens to final position. Stop it in any position by touching any button.

Note

The sliding/lifting roof opens until it reaches the best position from the point of view of noise. It can be opened fully, however, if you press the rocker switch again.

Readiness for operation

- With the ignition switched on (engine on or off) **or**
- With door closed and ignition key withdrawn, but only until door is first opened.

B - Closing the sliding/lifting roof

- ▷ Press front of rocker switch **B** until the sliding/lifting roof has reached the desired position.

One-touch operation

- ▷ Touch front of rocker switch **B**.
Sliding/lifting roof closes to final position.
Stop it in any position by touching any button.

C - Lifting sliding/lifting roof

- ▷ Press centre of rocker switch **C** until sliding/lifting roof reaches the desired position.

One-touch operation

- ▷ Touch the rocker switch **C** in the centre.
Sliding/lifting roof opens to final position.
Touch button again to stop in any position.

B - Lowering the sliding/lifting roof

- ▷ Press front of rocker switch **B** until the sliding/lifting roof has reached the desired position.

Emergency operation

Before using emergency operation, please check whether the fuses are defective.

- ▷ Please observe the chapter “ELECTRICAL SYSTEM” on page 210.

Warning!

Danger of injury and damage.

- ▷ Do not operate the sliding/lifting roof with the rocker switch during and after emergency operation.

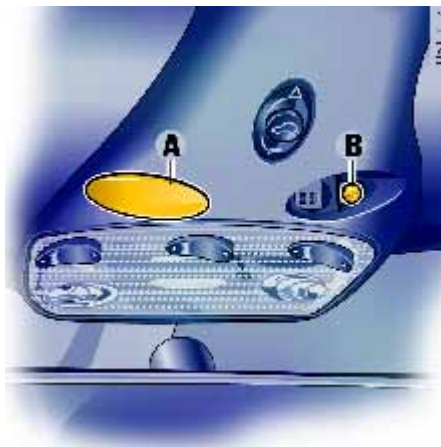

Closing the sliding roof

1. Carefully unclip both covers **A** with a screwdriver.
If the car is equipped with HomeLink, the HomeLink buttons must be carefully unclipped instead of the covers.
2. Unscrew the two screws **B**.
3. Fold down the cover of the sliding/lifting roof drive at the rear.
Remove the Allen key (**arrow**) from its holder.
4. Insert the Allen key into the drive spindle.



⚠ Caution!

Risk of damage to sliding/lifting roof.

- ▷ After emergency operation, do not operate the sliding/lifting roof using the rocker switch.

5. Press the Allen key into the drive spindle, keep it pressed and turn it clockwise until the sliding/lifting roof is closed.
6. Remove the Allen key.
Close the cover and screw in the screws.
7. Have the fault remedied.
Consult a qualified specialist workshop. We recommend a Porsche partner for this work as they have trained workshop personnel and the necessary parts and tools.

Convertible Top

Brief operating instructions can be found on the back of the driver's sun visor.

- ▷ Please observe the chapter "CAR CARE INSTRUCTIONS" on page 190.

Safety notes!

Do not operate convertible top:

- ▷ At temperatures below 0 °C (32 °F).
- ▷ When one side of the car is on a kerb, a lifting platform or a jack.
- ▷ When items of luggage or other objects hinder the movement of the convertible top.
- ▷ With the roll-over bars extended.
- ▷ Avoid frequent operation of the convertible top with the engine off; the vehicle battery will rapidly discharge.
- ▷ Only drive with the convertible top fully open or closed (end positions).
- ▷ When opening or closing the convertible top, ensure there is sufficient clearance above (e.g. in the garage).

- ▷ To prevent damp stains and abrasion damage, open the convertible top only when it is in a dry, clean state.
 - ▷ Park car in the shade if possible, since continuous exposure to the sun attacks textiles, rubber and colours.
 - ▷ The convertible top may only be actuated when driving on even surfaces.
 - ▷ The convertible top must not be operated with strong head wind (over approx. 80 km/h or 50 mph).
-

Door windows and side windows

The side windows are lowered automatically when **the convertible top is opened**. The door windows close automatically if the convertible-top continues to be operated after it has reached its final position.

When the door windows are closed, the rear side windows can also be closed.

The rear side windows open automatically when the door windows are opened.

The side windows are lowered automatically when **the convertible top is closed**. All windows close automatically if the convertible-top continues to be operated after it has reached its final position.

Conditions for operating the convertible top

With the rocker switch

- The ignition must be switched on (engine running or switched off),
- The engine compartment lid must be closed,
- Maximum speed up to approx. 50 km/h (30 mph).
Opening/closing of the convertible top will be interrupted if the maximum speed is exceeded.

With the remote control

- The engine compartment lid must be closed.

Opening the convertible top



Warning!

Danger of injury and damage.

- ▷ When opening the convertible top, make sure that nobody is at risk of injury from the convertible-top mechanism or the lid of the convertible-top compartment.
- ▷ Before opening the convertible top, ensure that there are no objects in the area behind the rear seats.



- ▷ Do not operate the convertible top with the remote control if the vehicle is out of your sight.
- ▷ In order to interrupt convertible-top operation in the event of danger, immediately release the switch or remote control.
- ▷ Please observe the chapter "WARNINGS ON THE INSTRUMENT PANEL AND THE ON-BOARD COMPUTER" on page 106.

Opening convertible top with the rocker switch

- ▷ Pull and hold up the switch until the convertible top has reached its final position or until the door windows are in their desired position. The message on the on-board computer goes out.
In case of danger, release the switch. Convertible top operation stops.

Opening convertible top with remote control (depending on country-specific vehicle equipment)

- ▷ Unlock the vehicle.
Keep the convertible-top button on the remote control depressed until the convertible top has reached its final position or until the door windows are in the desired position. In case of danger, release the switch. Convertible top operation stops.
- ▷ Re-lock the vehicle if necessary.



Closing the convertible top



Danger of injury and damage.

- ▷ When closing the convertible top, make sure that nobody is at risk from injury from the convertible-top mechanism or the convertible-top compartment lid.
- ▷ Do not operate the convertible top with the remote control if the vehicle is out of your sight.
- ▷ In order to interrupt convertible-top operation in the event of danger, immediately release the switch or remote control.

- ▷ Keep the lids of the make-up mirrors in the sun visors closed when closing the convertible top.
-
- ▷ Please observe the chapter "WARNINGS ON THE INSTRUMENT PANEL AND THE ON-BOARD COMPUTER" on page 106.

Closing convertible top with the rocker switch

- ▷ Press and hold down the switch until the convertible top has reached its final position or until the windows are in their desired position. The message on the on-board computer goes out.
In case of danger, release the switch.
Convertible top operation stops.

Closing convertible top with remote control (depending on country-specific vehicle equipment)

- ▷ Unlock the vehicle.
Keep the convertible-top button on the remote control depressed until the convertible top has reached its final position or until the windows are in the desired position.
In case of danger, release the switch.
Convertible top operation stops.



If the convertible top does not lock in the windscreen frame:

- ▷ Open the convertible top again, start the engine and close the convertible top using the rocker switch.
Assist with the closing process by grasping the convertible top by the handhold and pulling it toward the windscreen frame (**arrow**).

Messages on on-board computer



Rear lid

If the engine compartment lid is open when the convertible top is activated, a message appears on the on-board computer. The convertible top cannot be opened.

- ▷ Close engine compartment lid.



Convertible top status

- ▷ Please observe the chapter "WARNINGS ON THE INSTRUMENT PANEL AND THE ON-BOARD COMPUTER" on page 106.

Emergency operation of the convertible top

- ▷ Before carrying out emergency operation of the top, please check the following:
Was the ignition switched on and was the engine compartment lid closed during operation of the convertible top with the rocker switch?
Are any of the electrical fuses defective?
- ▷ Please observe the chapter "ELECTRICAL SYSTEM" on page 210.

Warning!

Risk of injury and risk of damage during emergency operation.

There is a risk of crushing or pinching from all moving convertible-top parts.

- ▷ Always carry out emergency operation of the convertible top with the greatest care.
- ▷ Do not activate the convertible top during emergency operation.

Before emergency operation:

- ▷ Remove the ignition key so that the convertible top is not activated unintentionally.
- ▷ Take the screwdriver out of the tool kit. Please observe the chapter "LUGGAGE COMPARTMENT" on page 134.
- ▷ Fold the rear seat backrests forward.

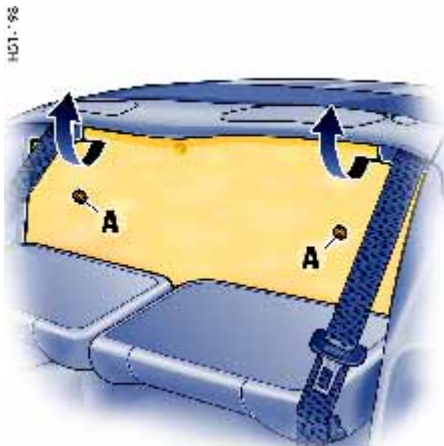

Removing the lining from the rear wall

1. Unscrew screws **A** from the rear wall lining. Pull out the screwdriver set as necessary and change.
2. Grasp the rear wall lining by the cut-outs for the seat belts and push downwards. Pull rear wall lining forward and lift up and out.

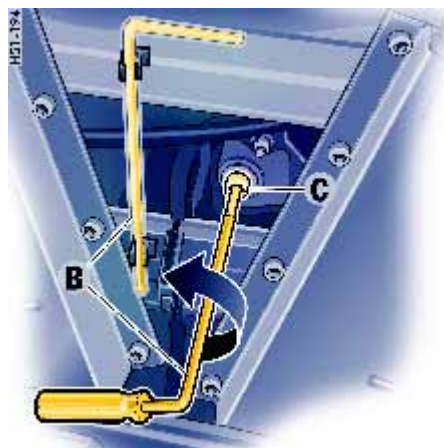

Opening the convertible-top compartment lid "D"

1. Take the red Allen key **B** out of its holder.
2. Plug the Allen key **B** into the screwdriver handle. Insert the Allen key into the drive spindle **C** and turn it counter-clockwise (in the direction of the arrow) until the convertible-top compartment lid **D** is fully open. Remove the Allen key.

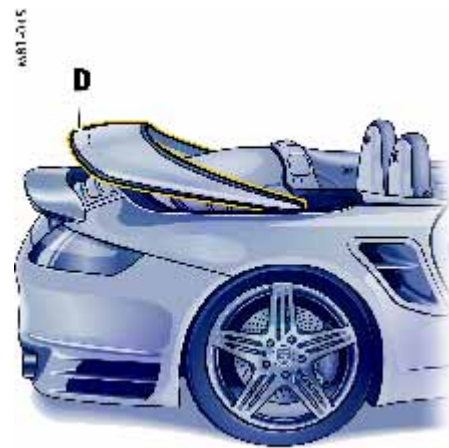

Warning!

Risk of injury. The Allen key may rotate or fly out if the convertible top is activated.

- ▷ Always remove the Allen key **B** from the drive spindle **C** before operating the convertible top.

When you have opened the convertible-top compartment lid, try to close the convertible top using the rocker switch. If the convertible top cannot be closed, continue with emergency operation.



Warning!

Risk of injury. The Allen key may rotate or fly out if the convertible top is activated.

- ▷ Always remove the Allen key **B** from the drive spindle of the side flap before operating the convertible top.
- ▷ When you have opened the side flaps, try to close the convertible top using the rocker switch.
If the convertible top cannot be closed, continue with emergency operation.

Opening the side flaps "F"

1. Remove ignition key.
2. Use the screwdriver to remove the plastic lid **E** from the lining from behind.
3. Insert the Allen key **B** into the drive spindle for the left side flap **F**.
Turn the Allen key counter-clockwise (**in the direction of the arrow**) until the side flap **F** is fully open (until you can feel it stop).
4. Repeat procedure with the right side flap.
Remove the Allen key.

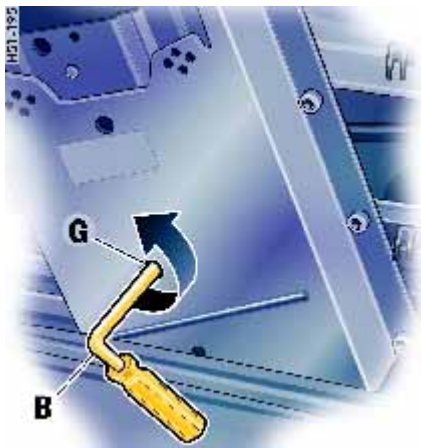

Closing the convertible top

1. Insert the Allen key **B** through hole **G** into the hydraulic valve.
Turn Allen key **B** approx. 1 turn counter-clockwise.
Always remove the Allen key **B**.



2. Position yourself behind the front seats and grasp the convertible top in the middle.



3. Close the convertible top until it reaches its highest point.

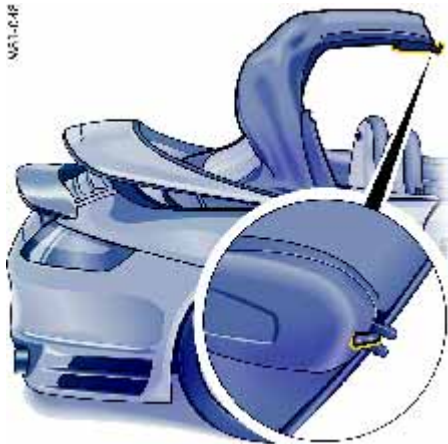

The lock with the locking hook is attached to the convertible top.
Please perform work on the convertible-top lock while standing on the right-hand side of the vehicle.



Extending the locking hook "H"

1. Pull the plastic lid **J** down on the front corners.
Push the lid carefully to the rear and take it off.



2. Take the Allen key **K** out of the oddments tray between the front seats.
3. Insert the Allen key **K** into the opening **L** and turn in the direction of arrow "open" until marked resistance can be felt.
The locking hook **H** is now extended.
4. Remove the Allen key.

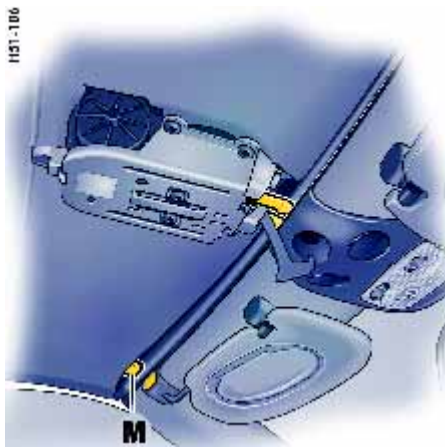

5. Pull the convertible top all the way forward to the windscreen frame.

Locking the locking hook "H" in the windscreen frame

- ▷ When locking the convertible top, make sure that the locking hook engages in the windscreen frame. Pull the convertible top to the windscreen frame if necessary. The centring pins **M** must enter the receptacles in the windscreen frame.

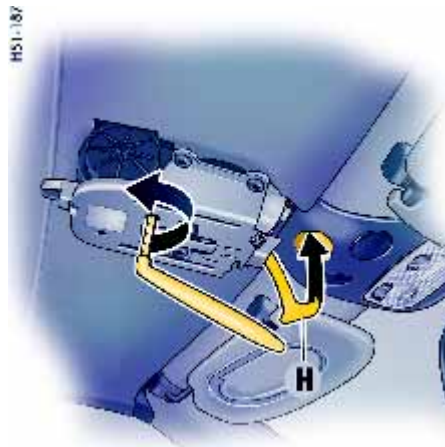

1. Insert the Allen key again. Turn in the direction of arrow "close" until you can feel marked resistance and the convertible top is completely locked.
2. Remove the Allen key.



Mounting the plastic lid

- ▷ Push the plastic lid over the convertible top locking mechanism from behind. The lid must engage centred in the guide **N**. Push the lid upwards at its front edge and engage.



Warning!

Risk of injury in an accident.

- ▷ Do not drive without the plastic lid mounted.

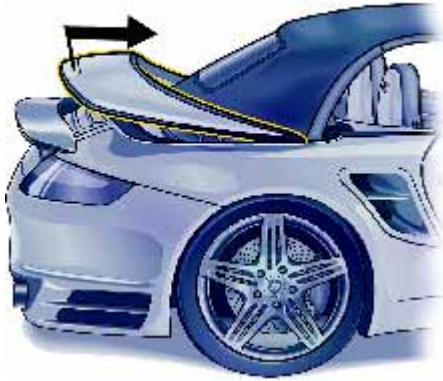

⚠ Caution!

Risk of damage to the convertible top.

- ▷ After emergency operation, do not operate the convertible top using the rocker switch or remote control.
- ▷ Drive slowly to a qualified specialist workshop. We recommend a Porsche partner for this work as they have trained workshop personnel and the necessary parts and tools.

Closing the convertible-top compartment lid

⚠ Warning!

Risk of pinching when closing the convertible-top compartment lid.

- ▷ Place your hands on the convertible-top compartment lid when pushing.
-
1. Stand behind the vehicle.
 2. Grasp the convertible-top compartment lid above the brake light and push forward against resistance which can be felt until it is completely closed.



Windstop

The windstop is stored in a protective bag in the luggage compartment.

The protective bag is fastened with a Velcro strip in the luggage compartment.

Caution!

Risk of damage to the windstop.

- ▷ Make sure that the windstop is not damaged by items of luggage or objects in the luggage compartment.
- ▷ Do not place any objects on the windstop.
- ▷ Do not store any objects with sharp edges under the installed windstop.
- ▷ Do not damage the windstop during seat adjustment and when folding back the backrests for the front seats. Adjust the seat so that the seat backrest does not touch the windstop.
- ▷ Do not fold up the rear seat backrests with the windstop installed.
- ▷ Remove the windstop before fitting the hardtop.

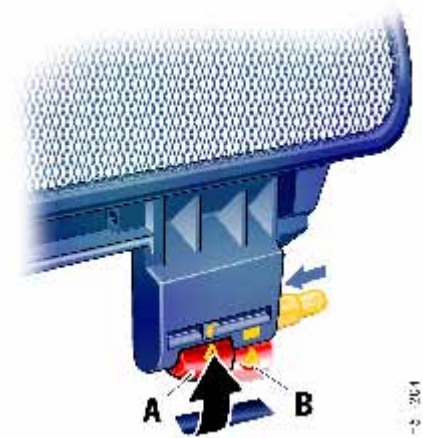
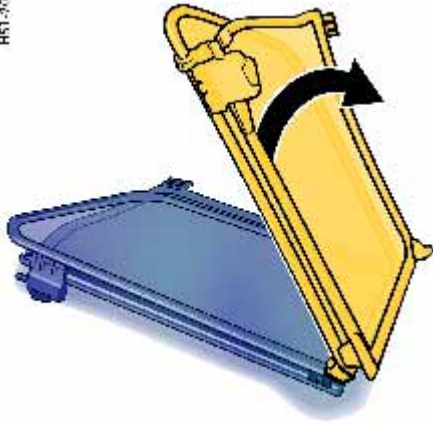

Installing the windstop

1. Open the zipper of the protective bag and take the windstop out of the luggage compartment.
2. Fold the rear seat backrests forward.
Please observe the chapter "REAR SEAT BACKRESTS" on page 28.
3. Unfold the windstop until you can feel it engage in the hinges at the top and bottom.

4. Check whether the lock of the windstop lower section is engaged.
Press lock together if necessary (**arrows**).

A - Lock open
B - Lock closed

5. Check whether the two red locking handles are in position **A** (open).
Open lock if necessary. To do this, push the red locking handles inward as far as they will go and swivel to the side (**arrow**).

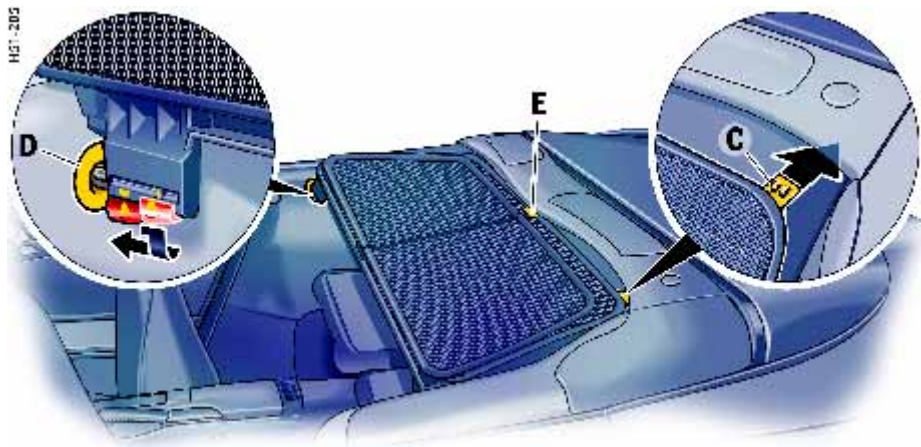

6. Insert the fastening tabs **C** of the windstop into the guides of the seat belts. Make sure that the plastic pin **E** engages in the centre guide of the windstop.

7. Press red locking handles inwards and swivel downwards. The spring pushes the square pins of the locks into the receivers **D** in the side trim panels. Check whether the square pins are correctly engaged.



8. Lift the upper section of windstop if required.

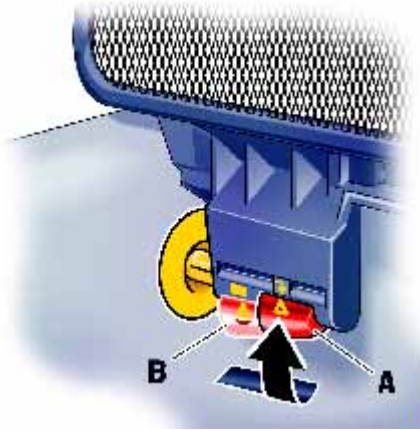

A - Lock open
B - Lock closed

Removing the windstop

1. Fold back the upper section of windstop.
2. Move both red locking handles to position **A** (open).
3. Pull the windstop out of the guides of the seat belts.

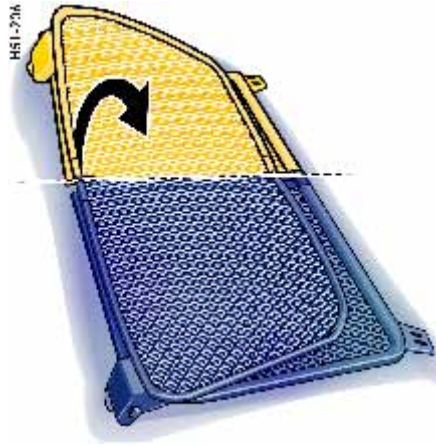

4. Fold the windstop together so that the split windstop lower section is on the outside.
5. Place the windstop in the protective bag in the luggage compartment and close the zipper of the protective bag.
Please observe the chapter "INSTALLING THE WINDSTOP" on page 165.

Hardtop

Storage

Your Porsche partner will be pleased to advise you about correct hardtop storage.

Make sure that the hardtop is placed on a clean, soft surface.

H51-209



H51-238

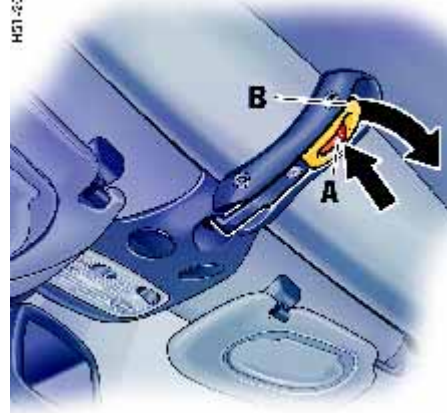

Removing the hardtop

1. Open all four side windows.
2. Pull off the plastic cover of the front hardtop lock (**arrow**).
3. Press the red locking button **A** of the front locking lever.
Fully open locking lever **B**.

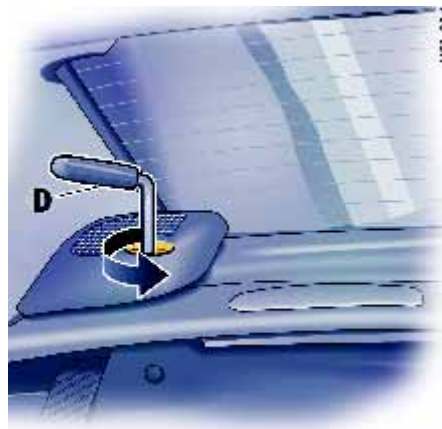
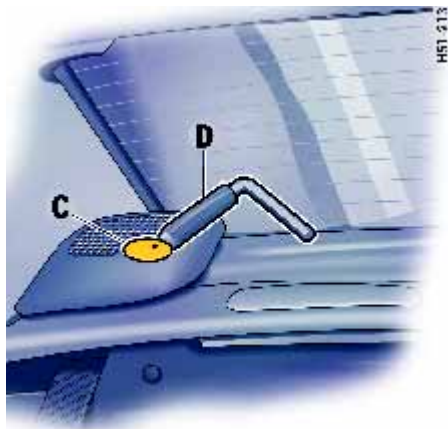

4. Take the unlocking handle **D** from the oddments tray between the front seats.
5. Position the unlocking handle **D** on the dot marking.
Carefully lever out the plastic covers **C** on both sides of the hardtop.

6. Insert the unlocking handle **D** into one of the rear hardtop locks.
Loosen fastening screw approx. 2 turns, take off handle, and completely loosen screw by hand (approx. 8 turns).
7. Pull out fastening screw up to stop and turn 2 turns to the left (secure against damage).
8. Repeat the procedure on the other side of the hardtop.

9. Together with a second person on the other side, grasp the hardtop at points **E** and **F**.

Warning!

Risk of pinching at points "F".

- ▷ Lift the hardtop evenly on both sides.

10. First lift the hardtop out of the locks at the rear.
Carefully lift the hardtop up and over the vehicle toward the rear.



11. Carefully unclip both protective covers **J**.
12. Fit both plastic covers **C** into the trim panel.
The marker dot must point to the rear.
These plastic covers are also used with the hardtop.
13. Close the front locking lever.
Fit the plastic cover of the front hardtop lock.

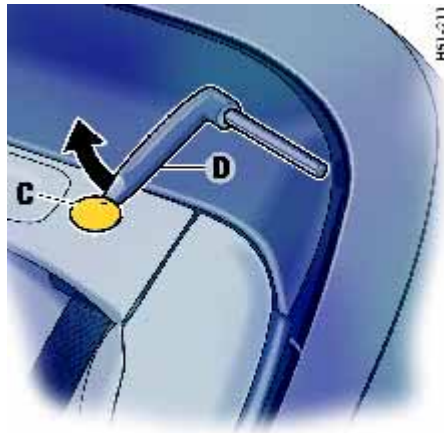

Fitting the hardtop



Caution!

Risk of damage to the windstop and hardtop.

- ▷ Always remove the windstop before fitting the hardtop.
Please observe the chapter "WINDSTOP" on page 164.



3. Position the unlocking handle **D** on the dot marking.
Carefully lever out both plastic covers **C**.
4. Fit both protective covers **J** into the trim panel.

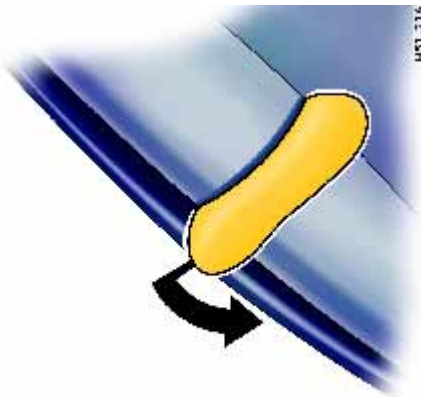

5. Pull off the plastic cover from the front hardtop lock.



6. Press red locking button of the front locking lever.
Fully open the locking lever.



Caution!

Risk of damage due to inadvertent operation of the convertible top when the hardtop is fitted.

- ▷ Make sure that the front locking lever **G** is always properly locked.
This disables the convertible-top drive.

7. Check whether the rear threaded joints on the hardtop are loosened (2 turns clockwise).
8. Together with a second person on the other side, grasp the hardtop at points **E** and **F**.
9. Carefully lift the hardtop up and over the vehicle from behind.
10. First push the hardtop fully into the guides on the windscreen frame.
Then carefully lower the hardtop into the locking elements at the rear.



HS1 2 19

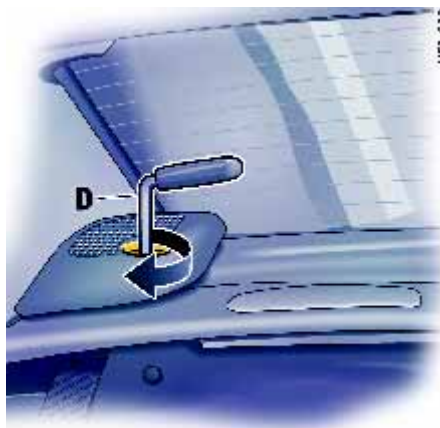

H51-213

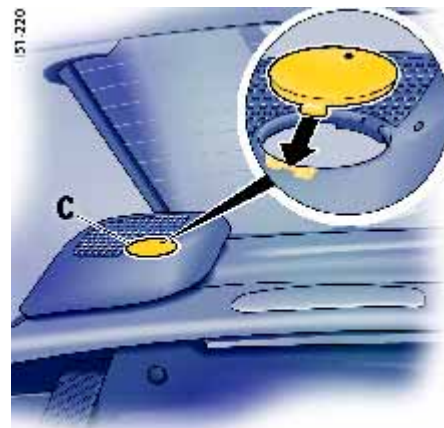

051 220

11. Swivel the front locking lever **G** to the rear. The locking hook **H** must engage in the windscreen frame (**arrow**). The white marking line **J** on the red locking button must be visible when the hardtop is locked properly.

12. Push on the plastic cover of the front hardtop lock.

13. Tighten the fastening screw by hand. Then tighten the fastening screw with the unlocking handle **D** (tightening torque 46 Nm (34 ftlb.)).

14. Repeat the procedure on the other side of the hardtop.

15. Fit both plastic covers **C** into the trim panels of the rear hardtop locks so that the marking dots are opposite each other.

16. Store unlocking handle in oddments tray between the front seats.

Roof Transport System

(Coupé only)

- ▷ Please follow the separate instructions for fitting the Roof Transport System.
- ▷ Only use Roof Transport Systems from the Porsche Tequipment product range or Roof Transport Systems which have been tested and approved for your car by Porsche. Fitting normal commercially available luggage racks is not possible.

The **Porsche Roof Transport System** allows you to carry various sports and hobby equipment. Your Porsche partner will be pleased to tell you about the various different uses of the Roof Transport System.

Safety notes!

- ▷ Completely remove the Roof Transport System before using an automatic car wash - risk of damage to the vehicle!
- ▷ Do not exceed the maximum permitted payload of 75 kg, the maximum permitted gross weight and the maximum permitted axle loads. Please observe the chapter "WEIGHTS" on page 242.
- ▷ Distribute load evenly, with heavy items as low as possible. Items of luggage must not project beyond the side of the load area.
- ▷ Fix and secure every item to the basic carrier with a rope or lashing strap (do not use elastic rubber tensioners).
- ▷ Before every journey, and at regular intervals during long trips, check that Roof Transport System and load are secure. Re-tighten if necessary and secure additionally by locking.

When the Roof Transport System is loaded, the maximum speed depends on the nature, size and weight of the load being carried.

- ▷ But never drive faster than 140 km/h (90 mph).
- ▷ With the basic carrier fitted and no load, do not exceed a maximum speed of 180 km/h (110 mph).

Driving, braking and steering behaviour change due to the higher centre of gravity and the greater wind-resistant area. You should adapt your driving style appropriately.

Since fuel consumption and noise are increased with the Roof Transport System fitted, it should not remain on the vehicle if not in use.

Maintenance, Car Care

Notes on Maintenance	176
Coolant Level.....	177
Engine Oils	178
Engine Oil Level	179
Brake Fluid Level.....	180
Emission Control System	182
Fuel.....	183
Fuel Can	184
Washer Fluid	185
Power Steering	186
Air Cleaner	187
Combination filter	187
Wiper Blades	188
Car Care Instructions.....	190

Notes on Maintenance

We recommend that you use your Porsche partner for carrying out this work.

Experienced, Porsche trained workshop personnel, supplied with the latest information as well as special tools and equipment are prerequisites for looking after your Porsche properly.

If, however, you work on your vehicle yourself, you must do it with great care. Only in this way is operational reliability fully guaranteed.

Unskilled maintenance work performed during the guarantee period may cause you to lose your claims.

Power measurements

Performance tests on roller test stands are not approved by Porsche.



Risk of death, injury and fire during maintenance work.

- ▷ Do not smoke in the vicinity of the battery or fuel system, and do not use a naked flame.
 - ▷ Only work on the vehicle in the open or in well-ventilated spaces.
 - ▷ Take care when working near hot engine parts.
 - ▷ Before working in the engine compartment, always switch the engine off and let it cool sufficiently.
 - ▷ If you have to work on the engine while it is running, always put the handbrake on and put the gearshift lever in neutral or the Tiptronic selector lever in position **P**.
 - ▷ Take great care to ensure that hands, fingers, articles of clothing (ties, sleeves, etc.), necklaces or long hair cannot be drawn in by the engine-compartment blower, the drive belt or other moving parts.
- ▷ The engine-compartment blower is mounted on the engine compartment lid. After the engine is switched off, the engine compartment temperature is monitored for approx. 30 minutes. During this period, and depending on temperature, the engine-compartment blower may continue to run or start to run. Carry out work in these areas only with the engine off and exercise extreme caution.
 - ▷ The radiators and radiator fans are in the front of the vehicle. The radiator fans in the front end of the car may be operating or unexpectedly start operating when the engine is switched on. Carry out work in these areas only with the engine switched off.
 - ▷ When the ignition is on, all cables and wires of the ignition system carry a high voltage. Special care is therefore required.
 - ▷ Always place the vehicle on stable supports if work has to be carried out under the vehicle. The car jack is not suitable for this.
 - ▷ Refill fluids, e.g. engine oil, washer fluid, brake fluid or coolant, are hazardous to health. Store refill fluids out of reach of children and, if necessary, dispose of these fluids properly.
-



Coolant Level

- ▷ Please observe the chapter “NOTES ON MAINTENANCE” on page 176.

The coolant provides year-round protection from corrosion and freezing down to -35°C (-31°F).

- ▷ Use only antifreeze authorised by Porsche.

Check coolant level

The expansion tank for the coolant is located on the left-hand side of the engine compartment.

- ▷ Check the coolant level regularly.

When the engine is cold and the car is level, the coolant level must lie between the minimum and maximum marks.

Topping up coolant

Warning!

Risk of scalding from hot coolant.

- ▷ Do not open the cap of the expansion tank while the engine is hot.

1. Switch engine off and let it cool. Please observe the chapter “COOLING SYSTEM” on page 70.
2. Cover the expansion tank cap with a cloth. Open cap carefully and allow overpressure to escape. Then unscrew cap completely.

3. Only add a mixture of antifreeze and water in equal parts, and do not exceed the Max. mark.

Antifreeze in coolant:

50 % provides anti-freeze protection down to -35°C (-31°F)

60 % provides anti-freeze protection down to -50°C (-58°F)

4. Screw cap on firmly.

If pure water is added in an emergency, the mixing ratio will have to be corrected.

Marked loss of coolant indicates leakage in the cooling system.

- ▷ The cause must be eliminated without delay. Consult a qualified specialist workshop. We recommend a Porsche partner for this work as they have trained workshop personnel and the necessary parts and tools.

Radiator fans

The radiators and radiator fans are in the front of the vehicle.

Warning!

Risk of injury. The radiator fans in the front end of the car may be operating or unexpectedly start operating when the engine is switched on.

- ▷ Carry out work in these areas only with the engine switched off.

Engine Oils

Porsche engines are designed so that no oil additives may be used.

Which oils are suitable?

- ▷ Use engine oils which have been tested and approved by Porsche only (Porsche approval list). Your Porsche partner will be pleased to advise you.
- ▷ A label is located in the engine compartment, which provides you with information (manufacturer) regarding the factory filling for your engine.
- ▷ Generally, manufacturer approvals are also printed on the oil canisters or on a notice at the dealer's.

These engine oils approved by Porsche can be mixed with each other. Since, however, each brand of oil has its own specially adapted composition, the same oil as used when changing the oil should be used when topping up if possible.

Regular oil changes are part of servicing.

- ▷ Change the engine oil more frequently in dusty areas.

Oil quality

Engine oil is not just a lubricant: it also fulfils many functions at the same time, such as component cooling, component cleanliness, and protection from corrosion. To be able to perform these tasks, the oil is given additives that have been specially developed for this purpose.

Mineral oils are extracted directly from crude oil. A series of chemical processes can further purify these oils (hydrocrack oils) or totally transform them (synthetic oils). These oils are more efficient than pure mineral oils.

Only hydrocrack or synthetic oils are approved by Porsche.

Non-seasonal light-running oils

Non-seasonal oils are distinguished by their low viscosity at low temperatures as well as a high level of temperature stability and a particularly low tendency to evaporate at high temperatures due to their composition. Oils which can meet such high performance requirements can be used as non-seasonal oils while taking into consideration the correct temperature range (see "Oils for the correct temperature range").

These oils also have good light-running properties because of their low viscosity at low temperatures and can therefore be referred to as non-seasonal light-running oils.

Only non-seasonal light-running oils are now approved by Porsche.

Viscosity

The viscosity (flow capability) is indicated by the SAE viscosity classes.

The first number and the letter W (winter) indicate the viscosity at low temperatures, e.g. 0W or 5W, and 5W oil is more viscous than 0W oil.

The second number indicates the viscosity at high temperatures, e.g. 40 or 50, and 40 is less viscous than 50.

Multi-grade oils are identified by both viscosity specifications, e.g. SAE 0W-40, 5W-40 or 5W-50.

Examples:

0W-40 and 5W-40 oils have the same viscosity at high temperatures; however, at low temperatures, 5W oil is more viscous.

5W-40 and 5W-50 have the same viscosity at low temperatures, but at high temperatures, the oil with viscosity class 40 is less viscous.

Oils for the correct temperature range

Above -25 °C (-13 °F): SAE 0W-40, 5W-40, 5W-50 approved by Porsche.

Below -25 °C (-13 °F): SAE 0W-40 approved by Porsche.

Engine oils approved by Porsche

Only oils on the Porsche approval list. Your Porsche partner will be pleased to advise you.

Engine Oil Level

- ▷ Regularly check the oil level using the on-board computer each time after the vehicle is refuelled.
Please observe the chapter “OIL DISPLAY AND MEASUREMENT OF THE ENGINE OIL LEVEL” on page 101.

The difference between the min. and max. marks on the segment display of the on-board computer is approx. 1.5 litres.

One segment of the display corresponds to a top-up quantity of approx. 0.5 litre.



Topping up engine oil

Porsche recommends **Mobil**.



Warning!

Risk of burning from hot parts in engine compartment.

The engine compartment blower on the engine compartment lid can start up even with the engine off.

- ▷ Exercise extreme caution when working on the engine compartment.
Please observe the chapter “NOTES ON MAINTENANCE” on page 176.
- ▷ Top up engine oil only with the engine off.

1. The on-board computer indicates how much oil must be added.
2. Switch off the engine.
3. Unscrew cap of the oil filler opening.
4. Add at most half a litre of engine oil at a time.
5. Measure oil level again with the on-board computer.
6. Add more engine oil if necessary.
Never add more engine oil than required to reach the max. mark.
7. Carefully close cap of the oil filler opening.

Brake Fluid Level

- ▷ Please observe the chapter “NOTES ON MAINTENANCE” on page 176.
- ▷ Only use genuine Porsche brake fluid or a brake fluid of similar quality which has been manufactured according to Porsche specifications and product requirements.

Warning!

Brake fluid is toxic and attacks paintwork and other surfaces.

- ▷ Store brake fluid out of the reach of children.
- ▷ Take care while topping up brake fluid not to soil the luggage compartment or items of luggage.

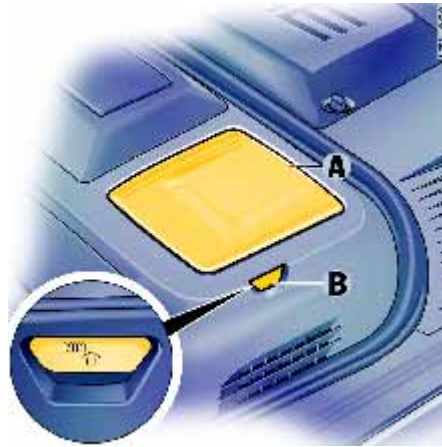

Checking the brake fluid level

The reservoir for the hydraulic braking system is located in the luggage compartment.

1. Open and remove cover flap **A**.
2. Regularly check the brake-fluid level on the transparent expansion tank through the window **B**.
The fluid level should always lie between the minimum and maximum marks.

A slight decrease in the fluid level due to wear and automatic readjustment of the disc brakes is normal.

If, however, the fluid level falls markedly or below the minimum mark, the braking system may have developed a leak.

- ▷ Have the braking system checked without delay. Consult a qualified specialist workshop. We recommend a Porsche partner for this work as they have trained workshop personnel and the necessary parts and tools.

Changing the brake fluid

Brake fluid absorbs moisture from the air over time. This accumulation of water lowers the boiling point and, under certain operating conditions, can affect the braking action. Therefore, have the brake fluid changed in accordance with the change intervals stated in the booklet "Guarantee and Maintenance".



Warning light and warning message

- The warning lights on the instrument panel and on the on-board computer indicate an insufficient brake fluid level.
- If the warning light lights up on the instrument panel and the warning message appears on the on-board computer in combination with a larger pedal travel, a brake circuit may have failed.

If the warning lights should light up whilst driving:

- ▷ Stop immediately in a suitable place.
- ▷ Do not continue driving.
Consult a qualified specialist workshop. We recommend a Porsche partner for this work as they have trained workshop personnel and the necessary parts and tools.

Emission Control System

Closed-loop three-way catalytic converters, combined with oxygen sensors and an electronic control unit, represent the most effective emission control system.

To ensure the efficiency of the emission control system, always have your vehicle serviced at the specified intervals.

To avoid permanent damage to the functionality of the catalytic converters and oxygen sensors, use unleaded fuel only.

The fuel tank ventilation system prevents fuel vapours from the tank entering the environment.

Tips on driving

Faulty preparation of the fuel/air mixture can cause the catalytic converters to overheat and can destroy them.



Risk of damage to emission control system.

- ▷ Avoid frequent and prolonged use of the starter if the engine does not start.
- ▷ If misfiring occurs while driving (identifiable by rough running of the engine, loss of power or an illuminated emission control warning light), have the fault remedied immediately. Consult a qualified specialist workshop. We recommend a Porsche partner for this work as they have trained workshop personnel and the necessary parts and tools.
- ▷ Avoid high cornering speeds after the fuel-level warning light lights up.
- ▷ Never drive the tank dry.
- ▷ Tow-start or push-start the car only if the engine is cold.
Cars equipped with “Tiptronic” cannot be tow-started or push-started.

Risk of fire in the area of the exhaust system.

- ▷ Do not apply additional undersealing or rust protection agent on or near the exhaust manifolds, exhaust pipes, catalytic converters or heat shields.
The protective material could overheat and ignite while you are driving.
 - ▷ Do not drive or park your vehicle where combustible materials, such as dry grass or leaves, can come into contact with the hot exhaust system.
-

Fuel



Warning!

Fuel is highly flammable and harmful to health.

- ▷ Fire, naked flame and smoking are prohibited when handling fuel.
 - ▷ Avoid contact with skin or clothing.
 - ▷ Do not inhale fuel vapours.
-
- ▷ Please observe the chapter "EMISSION CONTROL SYSTEM" on page 182.
 - ▷ Please observe the chapter "FUEL" on page 72.

To avoid permanent damage to the functionality of the catalytic converters and oxygen sensors, use **unleaded fuel only**.

The engine is designed to provide optimum performance and fuel consumption if **unleaded premium fuel with 98 RON/88 MON** is used.

If unleaded premium fuels with octane numbers of **at least 95 RON/85 MON** are used, the engine's knock control automatically adapts the ignition timing.

Note on operation

Information on the fuel quality is normally provided on the petrol pump. If this should not be the case, ask a petrol station attendant.

If the recommended fuel is not available, you can also use unleaded regular fuel (91 RON/82.5 MON) in an emergency.

However, this could reduce performance and increase fuel consumption.

- ▷ Avoid driving at full throttle.

In some countries the available fuel quality may not meet requirements, and this can lead to coking in the area of the intake valve.

In this case, the fuel may be mixed with the additive sold and recommended by Porsche after consulting a Porsche partner.

Porsche part number 000 043 206 89.

- ▷ Observe the instructions and mixture ratios provided on the container.

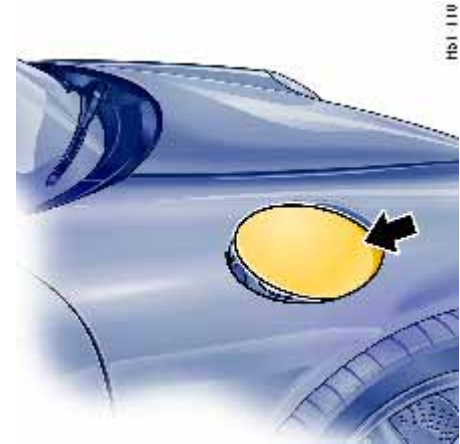

Opening the filler flap

The filler opening is under the filler flap in the front right wing.

- ▷ With the vehicle unlocked, press on the front part of the filler flap (**arrow**).

The filler flap is locked or unlocked by central locking.



If there is a fault in the automatic unlocking system:

- ▷ Open the passenger's door.
- ▷ Pull the ring in the right-hand door aperture (arrow).



Refuelling

Total capacity

The fuel filling capacity is approx. 67 litres, for right-hand drive vehicles approx. 66 litres.

- ▷ Please observe the chapter "CAPACITIES" on page 241.
1. Stop the engine and switch off the ignition.
 2. Slowly unscrew the tank cap.
Hang the tank cap on the filler flap by its plastic strap.
The hissing noise heard when the tank filler cap is opened is "normal" and does not indicate a fault in the tank system.

3. Insert the pump nozzle fully into the filler neck with the handle of the pump nozzle facing down.
4. Do not add further fuel once the correctly operated automatic pump nozzle has switched off.
Fuel could spray or could run over when heated.
5. Replace the tank cap immediately after refuelling and turn it until you hear it and feel it engage.

If you lose the tank filler cap, you must replace it only with an original part.

Fuel Can



Danger!

Risk of fire or explosion if the fuel can is damaged in an accident and fuel escapes. Escaping vapours can be harmful to health.

- ▷ Do not carry a fuel can on journeys.
- ▷ Observe the relevant laws.



Adding washer fluid

Clean water is generally not enough to clean the windscreen and headlights. Depending on the season, add the corresponding additives to the water in a suitable mixture ratio.

Only use window cleaner concentrate which meets the following requirements:

- dilutability 1:100,
- phosphate free,
- suitable for plastic headlights.

We recommend that you use concentrated window cleaner approved by Porsche. Your Porsche partner will be pleased to advise you.

Summer filling

Water + concentrated window cleaner in the mixture ratio stated on the container.

Winter filling

Water + antifreeze + concentrated window cleaner in the mixture ratio stated on the container.

- ▷ Please observe all instructions on the concentrated window cleaner or antifreeze containers.

Adding washer fluid

1. Undo the cap (arrow).
2. Top up the washer fluid and carefully close the cap.



Warning message

If less than approx. 0.5 litre remains, a warning message appears on the on-board computer.

- ▷ Add washer fluid.

Washer Fluid

The reservoir with blue screw cap is located in the rear left of the luggage compartment (direction of travel).

Capacity

The washer fluid capacity is approx. 6 litres.



Power Steering

Warning!

Risk of accident. When the engine is stationary (e.g. when the car is on tow) or the hydraulic system fails, there is no power assisted steering.

Therefore, substantially more force will have to be exerted.

- ▷ Exercise great care when on tow.
- ▷ Have the fault remedied.
Consult a qualified specialist workshop. We recommend a Porsche partner for this work as they have trained workshop personnel and the necessary parts and tools.

Note

The flow noise heard at full steering lock is system related and does not indicate a defect in the steering system.

Checking hydraulic fluid

- ▷ Please observe the chapter “NOTES ON MAINTENANCE” on page 176.
- ▷ Only use genuine Porsche hydraulic fluid or a hydraulic fluid of similar quality which has been approved according to Porsche specifications and product requirements.

Check the fluid level with the engine stopped and **cold** (approx. 20 °C (68 °F)).

1. Start the engine and let it idle for approx. 20 seconds. Switch off the engine.
 2. Open the engine compartment lid.
 3. Open the reservoir cap.
 4. Wipe dipstick.
Close the cap and re-open. The fluid level should be below the “Cold” mark.
Add hydraulic fluid if necessary.
 5. Close cap carefully.
- ▷ If the fluid level has dropped significantly, have the cause remedied immediately.
Consult a qualified specialist workshop. We recommend a Porsche partner for this work as they have trained workshop personnel and the necessary parts and tools.

Air Cleaner

- ▷ Please observe the chapter “NOTES ON MAINTENANCE” on page 176.

Regular replacement of the filter element is part of servicing.

- ▷ In dusty conditions, check the filter element more frequently and replace if necessary.

Combination filter

The fresh air passing through the combination filter into the passenger compartment is virtually free of dust, pollen, and unpleasant odours.

- ▷ If the outside air is polluted by exhaust fumes, press the circulating-air button.

A dirty filter can be the cause of reduced air throughput:

- ▷ Have the filter replaced.
Consult a qualified specialist workshop. We recommend a Porsche partner for this work as they have trained workshop personnel and the necessary parts and tools.

Regular filter replacement is part of servicing.

Wiper Blades

Wiper blades that are in perfect condition are vital for a clear view.

- ▷ Replace the wiper blades twice a year (before and after the cold season) or whenever wiper performance deteriorates.

Caution!

Risk of damage if wiper arm accidentally falls back onto the windscreen.

- ▷ Always hold the wiper arm securely when replacing the wiper blade.

Risk of damage if wiper blades that are frozen in place are loosened incorrectly.

- ▷ Thaw the wiper blades before loosening them.

Maintenance note

Periodically clean the wiper blades with a window cleaner, especially after the vehicle has been washed in a car wash. We recommend Porsche window cleaner. If they are very dirty (e.g. with insect remains), they can be cleaned with a sponge or cloth.

If the wiper blades rub or squeak, this may be as a result of the following:

If the vehicle is washed in an automatic car wash, wax residues may adhere to the windscreen. These wax residues can only be removed by using a concentrated window cleaner.

- ▷ Please observe the chapter “WASHER FLUID” on page 185.

Please contact your Porsche partner for further information.

If the wiper blades are damaged:

- ▷ Replace damaged wiper blades as soon as possible.

Replacing windscreen wiper blades

Caution!

Risk of damage.

If the wiper blades are not changed properly, they can come loose when the car is moving.

- ▷ Check whether the wiper blades are seated securely. The wiper blades must engage in the wiper arm properly.

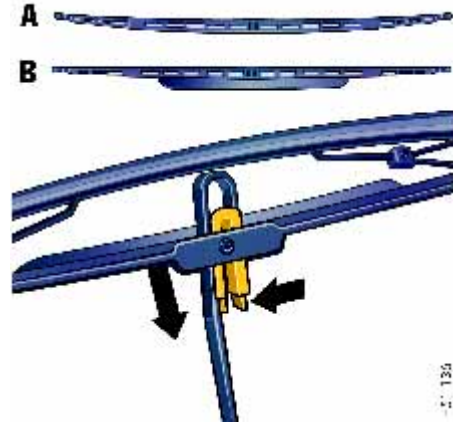

A - Passenger side, curved wiper blade
B - Driver side, wiper blade with spoiler

1. Apply the handbrake.
2. Switch the wipers off (position **O**) and remove the ignition key.
3. Fold wiper arm away from the glass.
4. Press together the plastic spring of the wiper blade (**right arrow**). Pull wiper blade upwards out of wiper arm.

5. Insert new wiper blade until you feel it engage. Ensure that the new wiper blade is inserted into the wiper arm in the same position:
 - direction of the spoiler on the driver side,
 - curvature on the passenger side.
6. Carefully fold wiper arm back onto the glass.

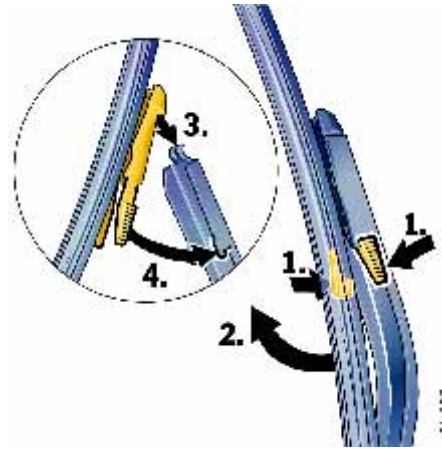

4. Press together the plastic spring of the wiper blade.
5. Pull wiper blade upwards out of wiper arm.
6. Insert new wiper blade into the wiper arm from above.
7. Press together the plastic spring of the wiper blade and engage it in the wiper arm until it snaps into place.
8. Carefully fold wiper arm back onto the glass.

Changing rear window wiper blade



Risk of damage.
If a wiper blade is not changed properly, it can come loose when the car is moving.

- ▷ Check whether the wiper blade is seated securely.
 The wiper blade must engage the wiper arm properly.

1. Apply the handbrake.
2. Switch the rear wiper off (position **O**) and remove the ignition key.
3. Fold wiper arm away from the glass.

Car Care Instructions

Regular, skilled care helps to maintain the value of your Porsche and can be a precondition for the upholding of claims under the vehicle guarantee and warranty.

You can obtain suitable care products at your Porsche partner, individually or as a complete set.

- ▷ Follow the instructions for use on the packaging of care products.
- ▷ Keep care products out of reach of children.
- ▷ If necessary, dispose of these fluids properly.

To ensure that the vehicle's condition is expertly checked and that the warranty remains valid for the full period, every Porsche partner will inspect the level of care of the car and record the results in writing.

The Porsche partner will issue a Condition Report. The condition is certified in the "Guarantee and Maintenance" booklet under "Long-life Guarantee Condition Report".

High-pressure cleaning units



High-pressure cleaning units can damage the following components:

- convertible top,
 - tyres,
 - logos, emblems,
 - painted surfaces,
 - generator,
 - ParkAssist sensors.
 - ▷ Please observe the operating instructions from the unit manufacturer.
 - ▷ When cleaning with a flat-jet nozzle or a so-called "dirt blaster", maintain a minimum distance of 50 cm (20 inches).
 - ▷ Never use high-pressure cleaning units with a round-jet nozzle.
A high-pressure cleaning unit with round nozzle will damage your vehicle.
The tyres are particularly susceptible to damage.
 - ▷ Do not point the cleaning jet directly at any of the aforementioned components.
-

Washing

The best protection for the vehicle from the damaging effects of the environment is frequent washing and preservation. The underside of the vehicle should also be thoroughly washed at the end of the gritting season at the latest.

The longer road salt, road dust, industrial dust, insect remains, bird excrement, and tree exudations (resin, pollen), etc. are allowed to remain on the bodywork, the more serious is their harmful effect.

Washing a vehicle by hand is more environmentally harmful than using a car wash.

- ▷ Wash your vehicle only at sites provided for this purpose, to prevent soot, grease, oil and heavy metals from entering the environment.

Dark paints make even the smallest surface blemishes (scratches) more conspicuous than lighter colours.

Dark colours are also more susceptible to scratching because of the composition of their pigments and require particularly careful paint care.

- ▷ Do not wash your Porsche in direct sunlight or when its body is hot.
- ▷ When washing by hand, use plenty of water, a soft sponge or washing brush and a car shampoo. We recommend Porsche car shampoo.
- ▷ Begin washing the vehicle by thoroughly wetting the paintwork and rinsing the heavy dirt off.
- ▷ After washing the vehicle, rinse it thoroughly with water and leather it dry. Do not use the same leather to rub down as you use for cleaning the windscreen and windows.

Reduced or uneven braking action may be caused by wet brakes.

- ▷ After washing the vehicle, test the brakes and briefly brake the discs dry.

When doing so, make sure that following traffic is not affected.

Car washes

Optional add-on parts or parts which project beyond the contours of the vehicle may be damaged by design features of car washes.

The following parts are particularly susceptible to damage:

- Convertible top (hot wax treatment must not be used, as the wax attacks the convertible top material)
- External antenna (always unscrew)
- Windscreen wipers (always switch them off to prevent them wiping unintentionally in intermittent or sensor operation)
- Roof Transport System (always remove completely)
- Fixed rear spoiler or extended rear spoiler
- Wheels (the wider the rim and the lower the tyre height, the greater the risk of damage)
- High-gloss wheels (to prevent these from getting scratched, do not clean with the wheel-cleaning brushes of the car wash)
- ▷ Please consult the operator before using automatic car washes.
- ▷ Wash and leather by hand all points not reached by a car wash, such as door and lid seams or door sills.

Convertible Top

The useful life and appearance of the convertible top depend largely on expert care and operation.

Unskilful care and operation can damage the convertible top or make it leak. Never remove snow and ice with sharp-edged objects.

Cleaning the convertible top



Risk of damage due to the cleaning jet of the high-pressure cleaning equipment or hot wax treatment.

- ▷ Do not clean the convertible top with high-pressure cleaning equipment.
- ▷ No hot wax treatment.

Do not wash the convertible top every time you wash the car. Normally, rinsing the convertible top with clean water is sufficient.

- ▷ Brush dust off the convertible top in the direction of the weave using a soft brush.

- ▷ Only if there is heavy dirt, wet the convertible top with lukewarm water and a wash-shampoo & convertible-top cleaner, using a sponge or soft brush, and rub gently. Rinse wash-shampoo & convertible-top cleaner thoroughly off the convertible top with clean water. We recommend Porsche wash-shampoo.
- ▷ After washing, treat the convertible-top cover at least once a year with a special convertible-top care product. Do not allow the convertible-top care product to come into contact with paint or glass. If it does, remove immediately.
- ▷ If there is leakage in the convertible-top cover or at its seams and folds, a special convertible-top care product can be used.
- ▷ Please note the information on the containers. We recommend the Porsche convertible top care product.
- ▷ Remove bird excrement immediately. The acid this contains makes the rubber swell, and the convertible top will become leaky.
- ▷ Open the convertible top only when completely dry, otherwise damp stains and abrasion marks may occur which cannot be removed.
- ▷ Try to remove spots from the convertible-top cloth by rubbing carefully with a soft rubber sponge.

Door lock

- ▷ To prevent the door lock freezing during the cold season, cover the lock barrel during washing.
- ▷ If the lock freezes nevertheless, use an ordinary de-icer. In many cases, a well warmed key can help. Never use excessive force.

Paint

- ▷ Never rub a dusty vehicle with a dry cloth, because the grains of dirt will damage the paintwork.

Paint is exposed to multiple mechanical and chemical effects.

Strong sunlight, rain, frost and snow, ultraviolet radiation, rapid temperature changes, industrial dust and chemical deposits act on the paint in repeated succession.

In the long run, these factors can be combated only by regular and, above all, skilled care.

- ▷ Do not apply care products containing silicone to the convertible top and windows.
- ▷ Do not treat matt-painted components with preservatives or polishes, otherwise the matt effect will be lost.

Preservation

The paint surface becomes dull over time due to weathering. It is therefore necessary to preserve the paint regularly.

This keeps the paint shiny and elastic. Dirt is prevented from adhering to the paint surface and industrial dust is prevented from penetrating the paint.

Provided it is washed and treated with preservative regularly, the brand new finish of your vehicle will be retained for years to come.

- ▷ Simply apply paint preservative after washing the vehicle and polish it smooth.

Polishing

- ▷ Only when the original polish can no longer be obtained using preservatives should paint polish be used to clean the paint. We recommend Porsche paint polish.

Removing spots and stains

- ▷ Remove tar spatters, traces of oil, insects etc. as soon as possible with an insect remover, as they discolour the paint if left to work on it over time.
- ▷ Carefully wash the treated areas again.

Minor paint damage

- ▷ Have minor paint damage (cracks, scratches or stone damage) repaired immediately **before** corrosion begins. Consult a qualified specialist workshop. We recommend a Porsche partner for this work as they have trained workshop personnel and the necessary parts and tools.

If corrosion has already formed, it must be thoroughly removed. An anti-corrosion primer is then applied, followed by top coat paint. Paint data can be found on the vehicle's data bank.

Cleaning and preserving engine compartment

The engine compartment and the surface of the engine are treated with a corrosion inhibitor at the factory.

If grease solvents are used to clean the engine compartment or the engine is washed down, the process almost invariably removes the corrosion-inhibiting coating. It is then absolutely necessary to have a durable preservative applied to all surfaces, body seams, joints and assemblies in the engine compartment. This also applies when corrosion-protected parts are replaced.



Risk of damage to generator.

- ▷ Do not point the cleaning jet directly at the generator, or cover the generator.

Effective rust-proofing is particularly important during the cold weather season. If the car is driven frequently in areas where salt has been spread on the roads, the whole engine compartment should be cleaned thoroughly and subsequently sealed after the cold weather season to prevent salt from causing any lasting damage.

Windows

- ▷ Clean all windows regularly, inside and out, with window cleaner. We recommend the Porsche window cleaner. Do not use the same leather for painted surfaces and for drying the windows. Preservative residues could reduce transparency.
- ▷ Remove insect residues with insect remover.

Note

Door windows feature a water-repellent (hydrophobic) coating which prevents soiling of the windows. This coating is subject to natural wear and can be renewed.

- ▷ Consult a qualified specialist workshop. We recommend a Porsche partner for this work as they have trained workshop personnel and the necessary parts and tools.

Wiper blades

Wiper blades that are in perfect condition are vital for a clear view.

- ▷ Replace the wiper blades twice a year (before and after the cold season) or whenever wiper performance deteriorates.
- ▷ Periodically clean the wiper blades with a window cleaner, especially after the vehicle has been washed in a car wash. We recommend the Porsche window cleaner. If they are very dirty (e.g. with insect remains), they can be cleaned with a sponge or cloth.

If the wiper blades rub or squeak, this may be as a result of the following:

If the vehicle is washed in an automatic car wash, wax residues may adhere to the windscreen. These wax residues can only be removed by using a concentrated window cleaner.

- ▷ Please observe the chapter “WASHER FLUID” on page 185.

Please contact your Porsche partner for further information.

If the wiper blades are damaged:

- ▷ Replace damaged wiper blades as soon as possible. Please observe the chapter “WIPER BLADES” on page 188.

Undersealing

The underside of the vehicle is lastingly protected against chemical and mechanical effects.

Damage to this protective layer while driving cannot be ruled out.

The vehicle underside should therefore be checked and repaired at regular intervals by a qualified specialist workshop.



Risk of fire in the area of the exhaust system.

- ▷ Do not apply additional undersealing or rust protection agent on or near the exhaust manifolds, exhaust pipes, catalytic converters or heat shields. The protective material could overheat and ignite while you are driving.

After washing the underside, cleaning the engine or repairing a unit, the unprotected parts must be preserved using suitable materials.

Stainless steel tailpipes

Stainless steel tailpipes may suffer discolouration caused by contamination, major heat build-up and combustion residue.

The original gloss can be recovered using commercially available metal lustre paste or metal polish.

Light alloy wheels

- ▷ Please observe the chapter “CAR WASHES” on page 191.

Metal particles (e.g. brass or copper in brake dust) must not remain too long on light alloy wheels.

Contact corrosion can cause pitting.

- ▷ If possible, wash the wheels every two weeks with a sponge or washing brush. Where there is road salt, grit or industrial dust, weekly cleaning is necessary.

For this purpose, use a cleaner for light alloy wheels (pH value 9.5). Products with the wrong pH value can destroy the protective layer on the wheels.

We recommend Porsche cleaner for light alloy rims.

Cleaners with an oxide-removing effect, as are commonly used for other metals, as well as mechanical tools and products, will damage the oxide layer and are therefore unsuitable.

- ▷ Every three months, after cleaning, grease the wheels with car wax or an acid-free grease (Vaseline). Rub the grease in well with a soft cloth.



Warning!

Danger of accident if cleaning agents (e.g. wheel cleaning agents) come into contact with the brake discs. The resulting film on the brake discs can impair braking performance.

- ▷ Make sure that no cleaning agent comes into contact with the brake discs.
- ▷ If cleaning agent has come into contact with the brake discs, thoroughly clean the brake discs with a strong jet of water.
- ▷ Paying attention to any road users behind you, dry the brake discs by applying the brakes.

Door, roof, lid and window seals

- ▷ Wash dirt (e.g. abrasion, dust, road salt and grit) from all seals regularly using warm soapy water. Do not use any chemical cleaning agents or solvents.

When there is a frost hazard, the outer door seals and the lid seals can be protected against freezing into place with a suitable care product.

In order to prevent damage to the anti-friction coating, the inner door seals and the convertible-top and hardtop seals must not be treated with care products.

Headlights, lights, interior and exterior plastic parts, decals

- ▷ Only use clean water and a little dishwasher detergent to clean headlights, lights, plastic parts and surfaces.
Do not clean when dry.
Use a soft sponge or a soft, lint-free cloth.
Gently wipe the surface without applying too much pressure.
An inside window cleaner is also suitable for cleaning plastic surfaces. Follow the cleaning instructions on the container.
We recommend Porsche inside window cleaner.
Never use other chemical cleaners or solvents.
- ▷ Rinse cleaned surfaces with clear water.

Leather

Characteristics and special features

The natural surface characteristics of leather, such as creases, healed scars, insect sting marks, structural differences and slight variations in shade and grain add to the attractiveness of the natural leather product.

A special mention must be made here of natural leather. For natural leather, carefully selected hides of the highest quality are used. It is not covered completely with dye on production. "Nature's signature" is therefore easily recognizable. This fine material is distinguished by an outstanding seating comfort, special suppleness and a typical patina.

Leather care and treatment

- ▷ All types of leather should be cleaned regularly to remove fine dust using a soft, damp, white woollen cloth or a commercially available microfibre cloth.
- ▷ Remove heavy contamination with a leather cleaner.
Please always follow the instructions for use given on the containers.
We recommend the Porsche leather care product.

Caustic cleaners and hard cleaning objects must not be used.

Perforated leather must under no circumstances get wet on its reverse side.

- ▷ Once cleaned, leather (particularly the heavily stressed leather seats) must be treated only with a leather care liquid. We recommend the Porsche leather care product.

Carpet, floor mats

- ▷ Use a vacuum cleaner or a brush (not too soft) for cleaning.
- ▷ Remove heavy dirt and stains with a stain remover. We recommend Porsche stain remover.

To protect carpets, the Porsche range of accessories includes non-skid floor mats of the correct size.



Warning!

Risk of accident.

- ▷ Do not obstruct the pedal travel with floor mats.

Cleaning airbag covers



There is a danger of severe or fatal injuries if operation of the airbag system is impaired by improper cleaning work.

- ▷ Do not make any modifications whatsoever to individual components such as the padded covers of the steering wheel, the switch panel, the front seats and the door trim panels.
- ▷ Let your Porsche partner clean these components.

Alcantara

Do not use a leather care product to clean Alcantara.

For regular care it is sufficient to clean the cover with a soft brush.

Heavy abrasion or rubbing when cleaning causes a lasting change in the surface.

Cleaning when lightly soiled

- ▷ Wet a soft cloth with water or a neutral soap solution and wipe off the dirt.

Cleaning when heavily soiled

- ▷ Wet a soft cloth with lukewarm water or thinned white spirit and dab the dirt from the outside in.

Seat belts

If it becomes necessary to clean the belts, a mild detergent can be used.

When drying, avoid direct sunlight.

- ▷ Only use suitable cleaning agents.
- ▷ Do not tint or bleach the belts. The belt fabric could be weakened, thus affecting safety.

Laying up your Porsche

If you wish to keep your Porsche off the road for a lengthy period, we recommend that you contact your Porsche partner. They will be glad to advise you about the necessary measures, e.g. corrosion prevention, care, maintenance and storage.

- ▷ Please observe the chapter “BATTERY” on page 214.

Practical Tips, Minor Repairs

Notes on Minor Repairs	198
Tyres and Wheels	199
Wheel Bolts	204
Flat Tyre	205
Changing a Wheel	208
Electrical System	210
Battery	214
Jump Lead Starting	218
Bulb Chart	220
Replacing Bulbs	220
Headlights	221
Tail Light	227
Number Plate Light.....	228
Additional Brake Lights	228
Changing Headlights from Left to Right-Hand Traffic.....	229
Headlight Adjustment.....	230
Towing and Tow-Starting.....	231

Notes on Minor Repairs

We recommend that you use your Porsche partner for carrying out this work.

Experienced, Porsche trained workshop personnel, supplied with the latest information as well as special tools and equipment are prerequisites for looking after your Porsche properly.

If, however, you work on your vehicle yourself, you must do it with great care. Only in this way is operational reliability fully guaranteed.

Unskilled maintenance work performed during the guarantee period may cause you to lose your claims.

Warning triangle, first aid kit and tool kit

- ▷ Please observe the chapter “LUGGAGE COMPARTMENT” on page 134.

Some countries require additional tools and special spare parts to be carried. Please make enquiries before driving abroad.



Risk of death, injury and fire during maintenance work.

- ▷ Do not smoke in the vicinity of the battery or fuel system, and do not use a naked flame.
- ▷ Only work on the vehicle in the open or in well-ventilated spaces.
- ▷ Take care when working near hot engine parts.
- ▷ Before working in the engine compartment, always switch the engine off and let it cool sufficiently.
- ▷ If you have to work on the engine while it is running, always put the handbrake on and put the gearshift lever in neutral or the selector lever in position **P**.
- ▷ Take great care to ensure that hands, fingers, articles of clothing (ties, sleeves, etc.), necklaces or long hair cannot be drawn in by the engine-compartment blower, the drive belt or other moving parts.
- ▷ The engine-compartment blower is mounted on the engine compartment lid. After the engine is switched off, the engine compartment temperature is monitored for approx. 30 minutes. During this period, and depending on temperature, the engine-compartment blower may continue to run or start to run. Carry out work in these areas only with the engine off and exercise extreme caution.
- ▷ The radiators and radiator fans are in the front of the vehicle. The radiator fans in the front end of the car may be operating or unexpectedly start operating when the engine is switched on. Carry out work in these areas only with the engine switched off.
- ▷ When the ignition is on, all cables and wires of the ignition system carry a high voltage. Special care is therefore required.
- ▷ Always place the vehicle on stable supports if work has to be carried out under the vehicle. The car jack is not suitable for this.
- ▷ Refill fluids, e.g. engine oil, brake fluid or coolant, are hazardous to health. Store refill fluids out of reach of children and, if necessary, dispose of these fluids properly.

Tyres and Wheels

The service life of the tyres depends on correct tyre filling pressure, correct wheel alignment and also your driving style.

Abrupt acceleration, high cornering speeds and heavy braking increase tyre wear. The tread wear is also greater at higher outside temperatures and on rough road surfaces.

Just like the engine, tyres always require the correct operating conditions. When correctly treated, they are a long-lived safety component on your Porsche.

For your own protection and that of other road users, you must observe the following instructions.

Load and speed

- ▷ Do not overload your vehicle. Be careful about the roof load. Overloading
 - + insufficient tyre pressure
 - + high speed
 - + high outside temperature (e.g. holiday driving)all add up to danger.

Tyre pressure

The tyre pressure must match the prescribed value. Details on tyre pressure are available in the left door aperture.

These values are for cold tyres (20 °C (68 °F)).

- ▷ Please observe the chapter “TPM TYRE PRESSURE MONITORING” on page 93.

When tyres are warm, the tyre pressure is increased.

- ▷ Never let air out of hot tyres. This could cause the tyre pressure to fall below the prescribed value.

Valve caps protect the valve from dust and dirt, and thus from leakage.

- ▷ Always screw caps down tightly.
- ▷ Replace missing caps immediately.

Insufficient tyre filling pressure can cause tyres to overheat and thus be damaged – even invisibly. Hidden tyre damage is not eliminated by subsequently correcting the tyre pressure.

Tyre damage

High-pressure cleaning units can damage the tyres.

- ▷ Please observe the chapter “HIGH-PRESSURE CLEANING UNITS” on page 190.



Risk of accident due to hidden tyre damage. Tyres may burst, especially at high speeds.

- ▷ Regularly check tyres, including the sidewalls, for foreign bodies, nicks, cuts, cracks and bulges.
- ▷ Cross kerb edges slowly and at right angles if possible. Avoid driving over steep or sharp kerbs.
- ▷ In cases of doubt, have the wheel (particularly the inner side) checked by an expert.

In the case of the following tyre damage, the tyre must be replaced for safety reasons:

- Tyre damage where the possibility of a ply fracture cannot be ruled out.
- If the tyre has been thermally and mechanically overloaded following a loss of pressure or other previous damage.

Maintenance note

Tyre repairs are not permissible under any circumstances. Sealing the tyre with tyre sealant is only an emergency repair so that you can drive to the next workshop.

Kerbs

Heavy or sharp-angled impacts against kerbs or sharp-edged objects (e.g. stones) can cause hidden tyre damage that only shows up later. Depending on the strength of the impact, the rim flange may also be damaged.

Storage of wheels

- ▷ Always store wheels in cool, dry, dark conditions. Tyres without wheels should be stored in a standing position.
- ▷ Avoid contact with petrol, oil and grease.

In no case should tyres be more than 6 years old.

The idea that tyres become more wear-resistant with storage and age has no foundation. Chemical additives that make the rubber elastic lose their effect in the course of time and the rubber becomes brittle.

The age of a tyre can be seen from the DOT code on the tyre sidewall.

If, for example, the last four digits are 1207, this means: the tyre was manufactured in the twelfth week of 2007.

Tread

The less tread, the greater the danger of aquaplaning.

- ▷ For safety reasons, replace the tyres **before** the wear indicators appear (webs in the tyre grooves, 1.6 mm high).
- ▷ Check tyre tread regularly, particularly before and after long journeys.

Wheel balancing

- ▷ As a precaution, have wheels with summer tyres balanced in the spring, and those with mud and snow tyres before winter.

Only specified weights may be used for wheel balancing.

Self-adhesive weights must not come into contact with cleaning agents, since they could drop off.

Changing a wheel

- ▷ When wheels are removed, mark the direction of rotation and position of each wheel.

Example:

FR (front right), FL, RR and RL.

- ▷ Always fit the wheels in accordance with their marking.

Wheel alignment

Uneven tread wear indicates incorrect wheel alignment. The vehicle should be checked if this should be the case.

- ▷ Consult a qualified specialist workshop. We recommend a Porsche partner for this work as they have trained workshop personnel and the necessary parts and tools.



Warning!

Risk of accident. You can lose control of the vehicle.

If, during a journey, uneven running or vibrations occur that could be caused by damage to tyres or the car:

- ▷ Reduce speed immediately, but without braking sharply.
- ▷ Stop the vehicle and check the tyres. If no cause for the fault can be found, drive carefully to the nearest qualified specialist workshop. We recommend a Porsche partner for this work as they have trained workshop personnel and the necessary parts and tools.

Replacing tyres

There is no obligatory standard regarding permitted top speed above 240 km/h (150 mph) for tyres of ZR quality.

- ▷ Before fitting new tyres, find out about the current approval status.
- ▷ Use only tyre makes tested and approved by Porsche.

Basically, only tyres of the same make, same type and with the same specification number (e.g. "NO", "N1"...) can be fitted..

In the initial period, tyres do not have their full traction.

- ▷ Therefore, do not drive above moderate speed during the first 100 - 200 km (60 - 120 miles).

If new tyres are fitted to only **one** axle, the different tread depths on the two axles can cause a marked change from the previous driving behaviour to which you have become accustomed. This is particularly true when new tyres are fitted to the rear axle.

The effect is reduced continuously, however, as tyre mileage increases.

- ▷ Adapt your driving style to the changed handling.

Tyres should only be fitted by specialist firms.

When a defective tyre is replaced, it should be noted that deviations in tread depth must not exceed 30 % on one axle.

- ▷ Do not use second-hand tyres if you do not know their history.

Valves

- ▷ Use only plastic valve caps.

The rubber valves must be replaced whenever the tyres are changed.

In the case of metal valves, please observe the fitting and replacement instructions.

Use only genuine Porsche metal valves or valves of the same quality, which are manufactured according to the specifications and production demands of Porsche.

- ▷ Protect the valve inserts against contamination with valve caps. Soiled valve inserts can cause a gradual loss of air.

Winter tyres



Warning!

Risk of accident due to excessive speed.

- ▷ Always observe the permissible maximum speed of the respective winter tyre.
 - ▷ Affix a sticker showing the maximum permissible speed in the driver's field of vision. Observe the country-specific laws.
-
- ▷ Fit winter tyres to both axles in good time before the cold season begins. Your Porsche partner will be pleased to advise you.
 - ▷ Before fitting new tyres, find out about the current approval status.
 - ▷ Use only tyre makes tested and approved by Porsche.

Maintenance note

We recommend fitting winter tyres on the vehicle at temperatures below 7 °C (45 °F) since the driving performance of summer tyres is reduced at low temperatures. Summer tyres may be permanently damaged at extremely low temperatures.

Winter tyres lose their suitability when their tread depth falls below 4 mm.

Changing a Wheel

- ▷ When wheels are removed, mark the direction of rotation and position of each wheel.
Example:
FR (front right), FL, RR and RL.
- ▷ Always fit the wheels in accordance with their marking.

Note

It can be useful during the winter to carry a hand brush and a plastic scraper for removing snow and ice, and dry sand for moving off on icy slopes.

Snow chains

Snow chains can be fitted to the rear axle only, with the tyre/wheel combinations listed in the Technical Data.

- ▷ Use only the fine-link snow chains recommended and authorised by Porsche so that sufficient clearance between the wheel well and the chain is assured.
- ▷ Before fitting chains, remove accumulated ice and snow from the wheel well.
- ▷ Observe the applicable national regulations regarding maximum speeds.
- ▷ Please observe the chapter "TYRES, RIMS, TRACKS" on page 239.



- A - Nominal width in mm
- B - Cross-section ratio in %
- C - Belt type code letter for radial
- D - Rim diameter in inches
- E - Load rating code number
- F - Speed code letter

Inscription on radial tyre

Speed code letter

The speed code letter indicates the maximum permissible speed for the tyre. This code letter is shown on the tyre sidewall.

- H = up to 210 km/h (130 mph)
- V = up to 240 km/h (149 mph)
- W = up to 270 km/h (170 mph)
- Y = up to 300 km/h (190 mph)

Tip on driving

- ▷ Tyres with a maximum speed rating that is lower than the specified maximum vehicle speed may be mounted only if they bear an M+S identification on the tyre sidewall (winter tyres).

Inscription on light alloy wheels

The rim width in inches and the rim offset are visible from the outside. This information can be found near the tyre valve.



- G - Rim width in inches
- H - Rim-flange contour code letter
- I - Symbol for drop-centre rim
- J - Rim diameter in inches
- K - Double hump
- L - Rim offset in mm

Tightening torque

Tightening torque of wheel bolts and wheel nuts:
130 Nm (96 ftlb.).

Security wheel bolts

The adapter (wrench socket) for the security wheel bolts is in the tool kit.

To loosen or tighten the wheel bolt with anti-theft protection, the adapter must be used between the wheel bolt and the wheel bolt wrench.

- ▷ When positioning the wrench socket, ensure that it engages fully in the teeth of the wheel bolt.

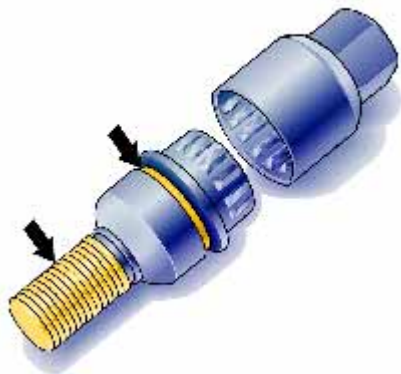

Wheel Bolts

- ▷ Always clean the wheel bolts before fitting.
- ▷ Apply a thin coat of **Optimoly TA** (aluminium paste) to the thread and between the bolt head and moveable spherical cap ring (**arrows**).
The bearing surface of the spherical cap facing the wheel must not be greased.
- ▷ Replace damaged wheel bolts.
 Only use genuine Porsche wheel bolts assigned especially to this model or wheel bolts of similar quality which have been manufactured according to Porsche specifications and production requirements.

Flat Tyre

1. Stop the vehicle as far away from the driving lane as possible.
The vehicle must be parked on a firm and flat surface offering adequate grip.
2. Switch on the hazard warning lights.
3. Pull the parking brake.
4. Shift into 1st gear or move the Tiptronic selector lever to position **P**.
5. Straighten the front wheels.
6. Withdraw the ignition key to lock the steering and prevent the engine from being started.
7. Have any passengers leave the vehicle.
8. Set up a warning triangle at a suitable distance.



A - Filler bottle
B - Filler hose

Tyre sealant

The tyre sealant can be used to seal small cuts, especially in the tyre tread.

Sealing the tyre with tyre sealant is only an emergency repair so that you can drive to the next workshop. Tyres repaired with sealant must be used only over short distances and in emergencies.

You can find tyre sealant and a compressor with pressure tester in the tool box in the luggage compartment.

F31-112

The tyre sealant comprises:

- a filler bottle
- a filler hose
- a valve turner
- a spare valve insert and
- a sticker denoting the maximum permissible speed for the driver's field of vision.

! Danger!

Risk of accident.

- ▷ Use the tyre sealant only in the case of cuts or punctures no larger than 4 mm.
- ▷ Never use the tyre sealant if the rim is damaged.

Warning!

The sealant is highly flammable and harmful to health.

- ▷ Fire, naked flame and smoking are prohibited when handling tyre sealant.
- ▷ Avoid contact with skin, eyes or clothing.
- ▷ Keep tyre sealant away from children.
- ▷ Do not inhale vapours.

In case of contact with the sealant:

- ▷ If sealant gets on the skin or in the eyes, thoroughly rinse the affected part of the body off or out without delay.
- ▷ Change soiled clothing immediately.
- ▷ Visit a doctor immediately in the event of an allergic reaction.
- ▷ If sealant was swallowed, thoroughly rinse out the mouth without delay and drink plenty of water.
Do not induce vomiting.
See a doctor immediately.

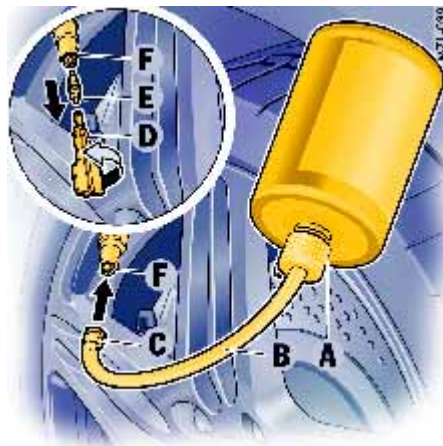

- A** - Filler bottle
- B** - Filler hose
- C** - Plug of the filler hose
- D** - Valve turner
- E** - Valve insert
- F** - Tyre valve

Filling in sealant

1. Leave the object that caused the puncture in the tyre.
2. Remove compressor, sealant and the enclosed sticker from the luggage compartment.
3. Adhere the sticker in the driver's field of vision.
4. Shake filler bottle **A**.

5. Screw filler hose **B** onto the filler bottle. The filler bottle is now open.
6. Unscrew valve cap from tyre valve **F**.
7. Remove valve insert **E** from the tyre valve with valve turner **D**.
Keep the valve insert in a clean and dry place.
8. Remove plug **C** of filler hose **B**.
9. Push filler hose onto the tyre valve.
10. Hold filler bottle higher than the level of the tyre valve and squeeze it forcefully until the bottle is completely emptied into the tyre.
11. Pull filler hose off the tyre valve.
12. Twist the valve insert firmly into the tyre valve using the valve turner.
13. Connect the compressor to the cigarette lighter and inflate the tyre to the prescribed tyre pressure.
Please observe the chapter "TYRE PRESSURES FOR COLD TYRES" on page 240.
14. Screw valve cap onto the tyre valve.
15. Check the tyre pressure after driving for around 10 minutes.
If the tyre pressure is less than 1.5 bar (22 psi), do not continue driving.
If a value of more than 1.5 bar (22 psi) is indicated, correct the pressure to the prescribed value.

16. Consult a qualified specialist workshop. We recommend a Porsche partner for this work as they have trained workshop personnel and the necessary parts and tools.

Care instructions

After drying, any sealant that emerges can be peeled off like a film.



Warning!

Risk of accident.

- ▷ Have tyre replaced by a specialist workshop as soon as possible. Inform the specialist workshop that the tyre contains sealant.
- ▷ Avoid hard acceleration and high cornering speeds.
- ▷ Observe maximum speed of 80 km/h (50 mph).
- ▷ Please always observe the safety and operating instructions, which can be found in the separate operating instructions for the sealant and on the compressor.



Front jacking point

Lifting the vehicle with a lifting platform or trolley jack

- ▷ The car must be raised only at the illustrated jacking points.



Rear jacking point

- ▷ Before driving the car onto a lifting platform, ensure that there is sufficient space between the lifting platform and the vehicle.
- ▷ In order to avoid serious damage, never jack up the vehicle at the engine, transmission or at the axles.

Changing a Wheel

Warning!

Risk of injury. The vehicle may slip off the jack.

- ▷ Make sure that no one is in the vehicle when jacking up and changing a wheel.
- ▷ Only use the jack to raise the car for wheel changing.
- ▷ Always place the vehicle on stable supports if work has to be carried out under the vehicle. The car jack is not suitable for this.

Note

The tools required for changing a wheel (e.g. jack, wheel bolt wrench, assembly aids) are not supplied as standard with the car. Your Porsche partner will be pleased to advise you.

1. Apply the handbrake fully and engage 1st gear or Tiptronic selector lever position **P** and remove the key from the ignition.
2. Secure the car against rolling away, e.g. by means of wedges under the wheels on the opposite side. This is particularly important on slopes.
3. Slightly slacken the wheel bolts of the wheel to be changed.
4. Raise the car until the wheel lifts off the ground. Lift vehicle only at the specified jacking points.
 - ▷ Please observe the chapter “LIFTING THE VEHICLE WITH A LIFTING PLATFORM OR TROLLEY JACK” on page 207.
5. Remove 1 or 2 wheel bolts (see corresponding figure). Screw in assembly aids instead of wheel bolts. Remove the remaining wheel bolts.

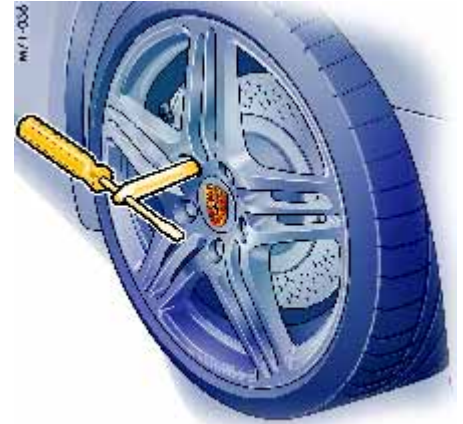

For vehicles **without** PCCB, screw in assembly aid

Caution!

Risk of damage to the brake discs.

- ▷ Always screw in the assembly aids when changing a wheel.

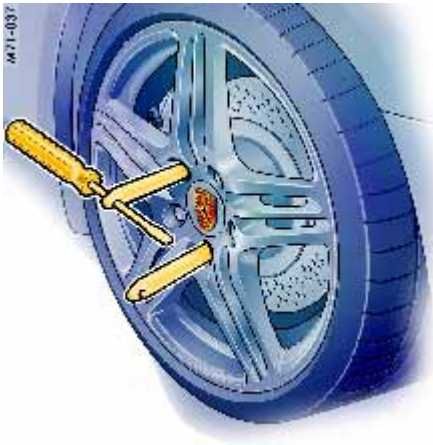

8. Lower the car completely.
 9. Tighten wheel bolts in diagonally opposite sequence.
- ▷ **Immediately after changing a wheel, use a torque wrench to check the prescribed tightening torque of the wheel bolts (130 Nm/96 ftlb.).**

For vehicles **with** PCCB, screw in **two** assembly aids

6. Take the wheel off and put a new wheel on.
7. Please observe the chapter "WHEEL BOLTS" on page 204.
Insert wheel bolts and tighten by hand.
Remove assembly aids, screw in remaining wheel bolts.
Initially tighten bolts only slightly in diagonally opposite sequence so that the wheel is centred.

Electrical System

In order to avoid damage and faults in electrical or electronic systems, work on the electrical system should be performed by a qualified specialist workshop. We recommend a Porsche partner for this work as they have trained workshop personnel and the necessary parts and tools.

- ▷ Use only accessories authorised by Porsche.

Warning!

Risk of short circuit and fire.

- ▷ Disconnect the battery during all work on the electrical system.

Relays

Relays should be checked or changed only by an authorised workshop.

Sockets

Electrical accessories should preferably be connected to the 12 V sockets.

- ▷ Please observe the maximum power consumption.



In oddments tray between the front seats

Note on operation

The tyre filling compressor must be connected to the cigarette lighter.

The sockets and thus the connected electrical accessories function even if the ignition is switched off or the ignition key is withdrawn.



*In the passenger's footwell
(Cabriolet with Bose Surround Sound System only)*

If the engine is not running and the accessories are switched on, the vehicle battery will be discharged.

Do not operate additional accessories for more than 5 minutes when engine is off.

Maximum power consumption for both sockets together or vehicles with one socket: 70 W.

- ▷ Please observe the power specifications from the accessory manufacturer.

Alarm system, central locking

The status of the central locking and alarm system is not changed by disconnecting the battery. When the battery is disconnected, the alarm system ceases to function.

Central locking overload protection

If the central locking system is operated more than ten times within a minute, further operation is blocked for 30 seconds.

Load switch-off after 2 hours or 7 days

If the ignition key is removed, loads which are switched on or are in standby (e.g. luggage compartment illumination, interior lights, radio) are automatically switched off after approx. **2 hours**.

If the vehicle is not started or unlocked with the remote control within **7 days**, the remote control standby function is switched off (to save the vehicle battery).

1. In this case, unlock the driver's door with the key at the door lock.
Leave the door closed in order to prevent the alarm system from being triggered.
2. Press **button 1** on the remote control.

The remote control is now activated again.



Changing fuses

In order to prevent damage to the electrical system due to short circuits and overloads, the individual circuits are protected by fuses. The fuse box is located in the driver's footwell.



A - Plastic gripper
B - Spare fuses

1. Switch off the load with the defective fuse.
2. Pull off plastic cover at the finger hole (**arrow**). The **fuse plan** and **instructions for emergency unlocking of the luggage compartment lid** can be found on the inner side of the cover.
3. Remove the corresponding fuse from its slot using the plastic gripper **A** in order to check it. A blown fuse can be identified by the melted metal strip.
4. Replace only with fuses of the same rating.

Note

- ▷ If a fuse blows repeatedly:
Consult a qualified specialist workshop. We recommend a Porsche partner for this work as they have trained workshop personnel and the necessary parts and tools.

Emergency unlocking of luggage compartment lid

If the battery is discharged, the luggage compartment lid can be opened only with the aid of a donor battery.

Note

The engine **cannot** be started with this method.

- ▷ Please observe the chapter “JUMP LEAD STARTING” on page 218.

Unlocking lid

1. Use the key to unlock the vehicle at the door lock.
2. Remove the plastic cover from the fuse box.
3. Pull out positive terminal **C** (red) in the fuse box using the plastic gripper **A** (yellow).

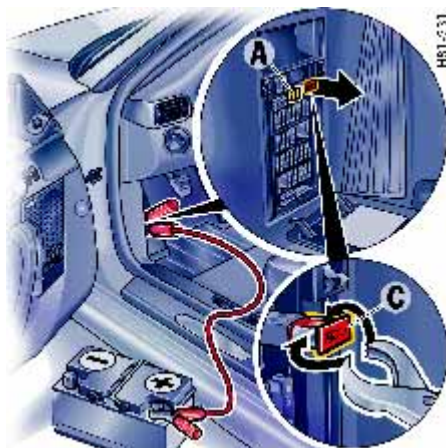

A - Plastic gripper (yellow)
C - Positive terminal (red)

4. Use a jump lead to connect the positive terminal of the spare battery to the positive terminal **C** in the fuse box.

Note

If the vehicle was locked, the alarm horn will sound when the negative lead is connected.

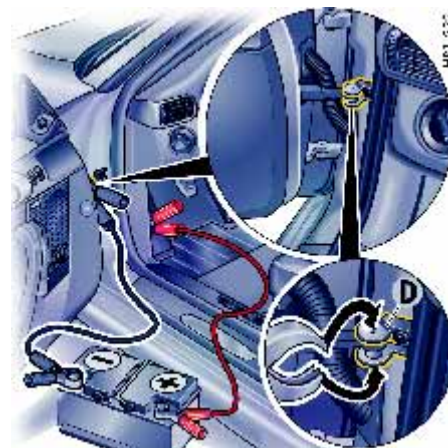

5. Use the black jump lead to connect the negative terminal of the spare battery to the door arrester **D**.
6. Press button **2** on the remote control for approx. 2 seconds to unlock the luggage compartment lid. The alarm system is switched off.
7. Disconnect the negative lead first, then the positive lead.
8. Push positive terminal **C** into the fuse box and push on the plastic fuse box cover.

Battery

- ▷ Please observe the chapter “EMERGENCY OPERATION – RELEASING THE IGNITION KEY” on page 61.

Warning!

Risk of short circuit and fire.

- ▷ Disconnect the battery during all work on the electrical system.
- ▷ Ensure that tools or conductive jewellery (rings, chains, watch straps) do not come into contact with live parts of the vehicle.

Danger of explosion as a result of static charge.

- ▷ Do not wipe battery with a dry cloth.
 - ▷ Eliminate potential electrostatic charge by touching the vehicle before touching the battery.
-

Heed warnings on the battery



Read the operating instructions



Wear eye protection



Keep children away



Danger of explosion

While the battery is being charged, a highly explosive gas mixture is formed, so:



Fire, sparks, naked flames and smoking are prohibited

Avoid causing sparks and short circuits when handling cables and electrical equipment.

In the case of batteries with central venting, there is a greater concentration of explosive gas at the hose opening. The gas-venting hose must not be kinked or blocked with dirt.



Danger of caustic burns

Battery acid is highly caustic, so: wear safety gloves and eye protection. Do not tip the battery, or acid may spill from the venting aperture.

First aid

If acid splashes into an eye, immediately rinse with clean water for a few minutes. See a doctor immediately. If acid splashes onto skin or clothing, neutralise immediately with soapsuds and rinse with plenty of water. If you accidentally drink acid, consult a doctor immediately.



Disposal

Hand in the old battery at a battery collection point.



Never dispose of an old battery with domestic waste.

Charge state

A well-charged battery prevents starting problems and has a longer service life.

Traffic density, speed limits, requirements regarding noise, exhaust gas and fuel consumption reduce the engine speed and, hence, the generator output.

However, the large number of electrical loads has markedly increased the demand for electrical power.

In order to avoid unintended battery discharge:

- ▷ Switch off unnecessary electrical loads in city traffic, on short trips and in queues.
- ▷ Always withdraw the ignition key when leaving the vehicle.
- ▷ Avoid frequent operation of the convertible top and operation of the Porsche Communication Management system when the engine is not running.

Battery care

- ▷ Keep battery surface clean and dry.
- ▷ Ensure that cell plugs and terminal clamps are firmly secured.

Checking acid level

The acid level should be checked more frequently by a qualified specialist workshop during the summer months and in predominantly warm countries.

Charging the battery

Your Porsche partner will be pleased to advise you about a suitable charger.

1. Always observe the instructions of the charger manufacturer.
Depending on the type of charger, the battery may have to be disconnected. Important: in this case, disconnect the negative lead first, then the positive lead - danger of short circuit!
Reconnection must be carried out in reverse order.
2. Before charging, cold batteries must be warmed up indoors.
3. Frozen batteries must not be charged. They must be replaced with a new battery.
4. When charging, ensure that there is adequate ventilation.

5. Connect the charger to the battery.
Only plug into the mains and switch the charger on when it has been correctly connected up.

Winter driving

The capacity and ability of the battery to store power decreases at low outside temperatures. Moreover, the battery is more heavily loaded in the winter months by the heated rear window, more frequent use of additional lights, the blower and the windscreen wipers, etc.

- ▷ Have the battery checked before the start of winter.

Keep the battery fully charged to prevent it from freezing.

A discharged battery can freeze even at $-5\text{ }^{\circ}\text{C}$ ($23\text{ }^{\circ}\text{F}$), but a fully charged one freezes only at $-40\text{ }^{\circ}\text{C}$ ($-40\text{ }^{\circ}\text{F}$).

Laying up the vehicle

If the vehicle stands for long periods in the garage or workshop, the doors and lids should be closed.

- ▷ Please observe the chapter “EMERGENCY UNLOCKING OF LUGGAGE COMPARTMENT LID” on page 213.
- ▷ Withdraw the ignition key and, if necessary, disconnect the battery.

When the battery is disconnected, the alarm system ceases to function!

Even if you put your vehicle out of operation, the battery still discharges.

- ▷ The battery must be charged, i.e. connected to a charger, approximately every 6 weeks in order to preserve functioning.
Always observe the instructions of the charger manufacturer.
- ▷ Store a battery that has been removed in a dark, cool place, but not subject to frost.

Replacing the battery

The battery is subject to normal wear: its service life depends heavily on the care you give it, climatic conditions and the conditions of use (distances, loads).

It is not possible to use the details on the battery case to determine a comparable battery that meets all the specific requirements of Porsche.

- ▷ Only replace the battery with one that satisfies the specific requirements of your vehicle. We recommend that you use an original Porsche battery.
- ▷ Please observe the disposal instructions for batteries!

Putting vehicle into operation

After the battery is connected or after an **exhaustively discharged** battery is charged, the multifunctional PSM light lights up on the instrument panel and a message appears on the on-board computer to indicate a fault.

This fault can be remedied with a few simple steps:

1. Start the engine.
2. With the vehicle stationary, perform a few steering movements to the left and right and then drive a short distance in a straight line until the multifunctional PSM light goes out and the message on the on-board computer disappears.
3. If the warnings do **not** disappear, then: Drive carefully to the nearest qualified specialist workshop.
Have the fault remedied.
4. After the warnings disappear:
Stop the vehicle in a suitable place.
5. Perform adaptation of the power windows: Close the windows **once** with the rocker switch.
Press rocker switch upwards again to store the final position of the windows in the control unit.

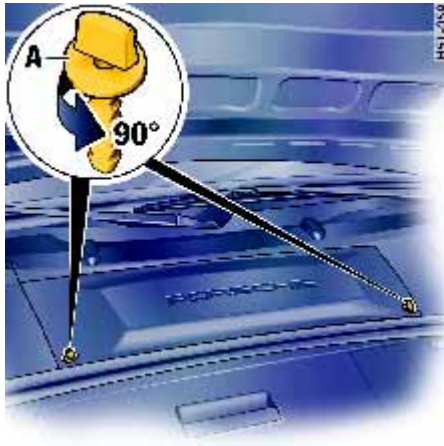

Removing the battery

The battery is located in the luggage compartment under a black plastic lid.

1. Switch off engine and all electrical loads.
2. Open turn-locks **A**.
Remove plastic lid.

Warning!

Risk of damage to generator and electronic control units.

- ▷ Do not disconnect battery while the engine is running.

Risk of caustic burns from escaping acid.

- ▷ Do not tilt the battery when removing it.

3. Pull off vent hose **C**.
4. Important: disconnect the negative lead first, and then the positive lead – danger of short circuit!
5. Unscrew fastening screw **B**.
6. Remove the battery.

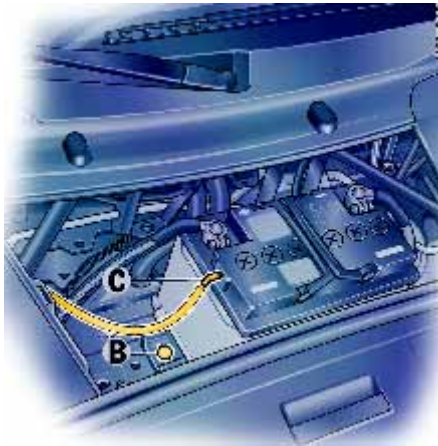

Installing the battery

1. Insert battery and push it all the way to the stop.
2. Turn in fastening screw **B**.
3. Important: connect the positive cable first and then the negative cable - risk of short circuit!
4. Push on vent hose **C**.
5. Fit plastic lid.
Lock turn-locks **A**.



Replacing the remote control battery

The battery should be changed when the range of the radio remote control becomes smaller or when the light-emitting diode no longer flashes when the remote control is operated.

HE 1-062

1. Using your finger nail or a small screwdriver, carefully lift off the cover of the key grip (arrow).
2. Replace the battery (paying attention to the polarity). Replacement battery (Lithium CR 2032, 3 Volt)
3. Replace cover and press together firmly. Please observe the disposal instructions for batteries.

Jump Lead Starting

- ▷ Please observe the chapter “EMERGENCY UNLOCKING OF LUGGAGE COMPARTMENT LID” on page 213.
- ▷ Please observe the chapter “BATTERY” on page 214.

If the battery is flat, the battery of another vehicle can be used to start the car with the aid of jump leads.

Both batteries must be 12 V types. The capacity (Ampere hours, Ah) of the donor battery must not be substantially less than that of the discharged battery.

The discharged battery must be correctly connected to the vehicle's electrical system.



Warning!

Risk of damage and injury due to short circuit.

- ▷ Use only standard jump leads with sufficient cross section and completely insulated clamps. Follow the jump lead manufacturer's instructions.
- ▷ Route the jump leads so that they cannot be caught by moving parts in the engine compartment. The vehicles must not be in contact, otherwise current might flow as soon as the positive terminals are connected.

- ▷ Carefully ensure that conductive jewellery (rings, chains, watch straps) does not come into contact with live parts of the vehicle.

Danger of caustic burns.

- ▷ Do not lean over the battery.

Danger of gas explosion.

- ▷ Keep sources of ignition away from the battery, e.g. naked flame, burning cigarettes or sparks due to cable contact.
 - ▷ Before connecting jump leads, it is essential to thaw out a frozen battery.
-

Connecting jump leads

Always observe the sequence below:

1. Connect the **positive lead (red)** to the positive terminal of the discharged battery first, then connect it to the positive terminal of the donor battery.
2. First connect the **negative cable (black)** to the negative terminal of the donor battery, then connect it to a suitable grounding point on the vehicle with the discharged battery. This grounding point must lie as far as possible from the battery.
For example, a solid metal part or the engine block are suitable grounding points.

If no suitable grounding points are to be found on either vehicle, the negative lead must carefully be connected directly to the negative terminal of the battery.

If a suitable grounding point is to be found only on the donor vehicle, the negative lead must first be connected to the terminal of the discharged battery, then to the grounding point of the donor vehicle.

3. Run the engine of the donor vehicle at a higher speed.
4. Start the engine.
An attempted start using jump leads should not last more than 15 seconds. Then allow a waiting period of at least one minute.

5. Note

Before disconnecting the jump leads, electrical loads such as the heated rear window and the heating fan blower should be switched on (the vehicle's lights must **not** be switched on). This reduces voltage peaks which may occur when disconnecting the jump leads.

With the engine running, remove both jump leads in reverse order.

Bulb Chart

	Type, rating
Dipped beam with Bi-Xenon headlight	Philips, D2S 35W
Additional high beam with Bi-Xenon headlight	H11, 55W
Fog light	H3, 35W
Tail light, rear fog light	P21W/4W
Brake light/tail light	P21W/4W
Tail light, reflector	P21W/5W
Reversing light	P21W
Direction indicator light, front and rear	PY21W
Direction indicator light, side	WY5W/3W
Side lights, front	W5W BV
Number plate light	C5W

Replacing Bulbs



Danger of short circuit.

- ▷ Always switch off the relevant load when changing bulbs.

Risk of injury. The Bi-Xenon headlights are under high voltage when installed.

- ▷ Exercise extreme caution when working in the area of the Bi-Xenon headlights.

Risk of damage. Bulbs of a higher wattage can damage the lamp housing.

- ▷ Only use the bulbs specified in the bulb chart.
-
- ▷ Bulbs must be clean and free from grease.
 - ▷ Never touch bulbs with your bare hands. Use a cloth or soft paper when replacing bulbs.
 - ▷ Always carry spare bulbs with you. In certain countries, it is mandatory to carry spare bulbs.

Headlights

Caution!

Risk of damage to headlights due to abrasion and excessive temperatures.

- ▷ Do not affix any coverings (e.g. “stone guards” or films) in the area of the headlights.

Note

The headlights may mist up due to temperature and humidity.

- ▷ To ensure optimum ventilation, do not cover the gap between headlight and body (e.g. “stone guards” or films).



Removing headlights

1. Unscrew plastic nut **A**.
Detach side carpeting.

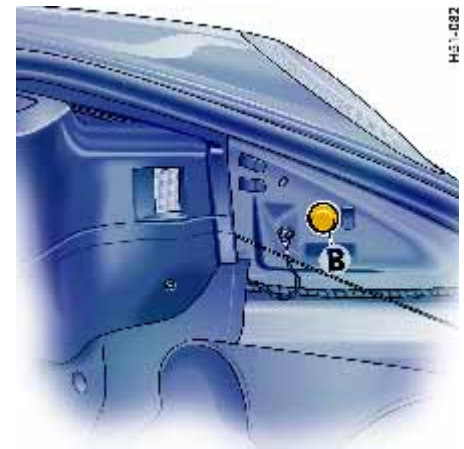

2. Remove rubber plug **B** from the unlocking opening.

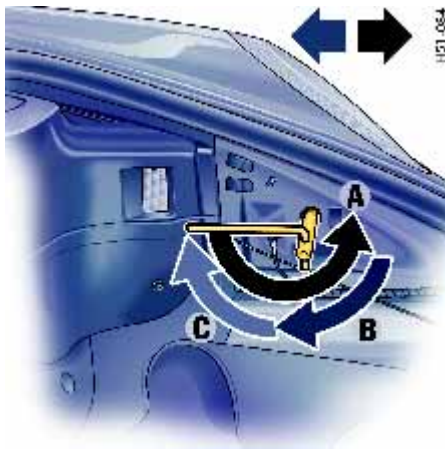

1151 084

Installing headlights

1. Insert headlight into the guide rails and push fully into the wing.
2. Push headlight to the rear and at the same time turn the socket wrench until it points horizontally to the rear **C**. The headlight locking device must perceptibly and audibly engage.
3. Insert rubber plug into the unlocking opening and secure the carpeting. Check the function of all lights.

3. Place socket wrench (tool kit) on the unlocking spindle. The handle of the wrench should point horizontally to the rear.
4. Turn socket wrench approx. 180°, see **A**. The headlight is unlocked and pushed forward slightly during this process.
5. Turn socket wrench back until it is pointing vertically downward **B** and leave in position.
6. The headlight is now unlocked and can be pulled forward out of the wing.

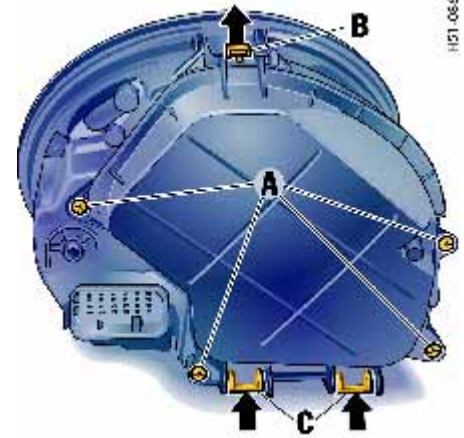

930 15H

Dipped beam, high beam and additional high beam

Opening the lid of the headlight housing

1. Unscrew the 4 screws **A**.
2. First lift release tab **B**, then push both release tabs **C** upwards and take off lid.

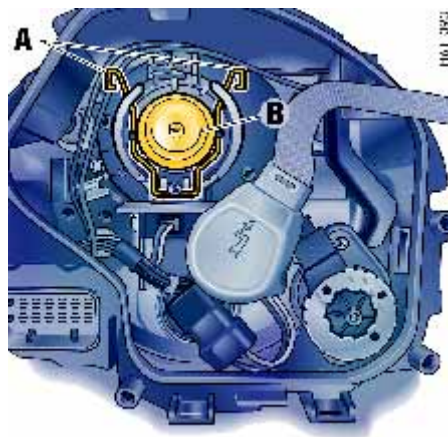
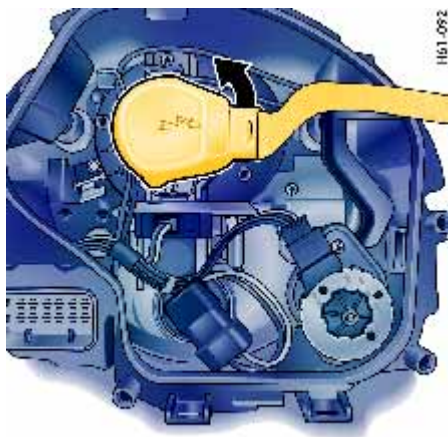

Changing bulb for dipped beam and high beam

1. Turn the plug counter-clockwise (bayonet lock) and pull it off.
2. Disengage both fixing clips **A**.
3. Replace defective bulb **B**.
When doing so, ensure bulb is seated properly.
4. Engage both fixing clips **A**,
push on plug and turn right as far as the stop.

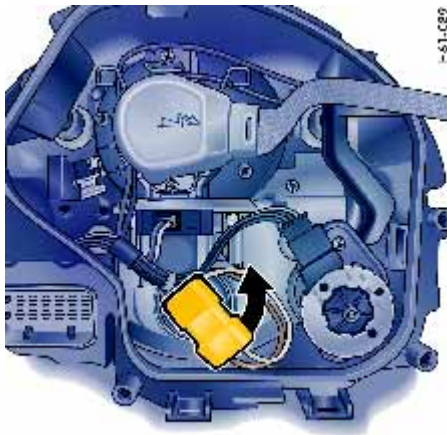

Changing bulb for additional high beam

1. Turn the bulb holder.
Turn it counter-clockwise on the left headlight and clockwise on the right headlight.
Take bulb holder out of the headlight housing.

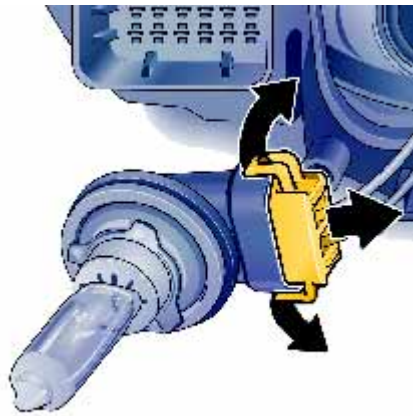

Closing lid of the headlight housing

1. Push on lid until it perceptibly engages.
2. Fasten lid with the 4 screws.

2. Pull both plug release tabs apart.
Pull plug out of the bulb holder.
3. Replace the defective bulb with bulb holder.
4. Reassemble in reverse order.



Direction indicator, front

The light-emitting diodes of the front direction indicator lights cannot be replaced individually.

- ▷ Have the defective direction indicator light replaced in a qualified specialist workshop. We recommend a Porsche partner for this work as they have trained workshop personnel and the necessary parts and tools.

Changing bulb for side light

1. Undo fastening screw.
2. Slide light housing slightly to outside of car and then remove to the front.
3. Turn holder towards the left and pull it out to the rear.
4. Pull out and replace defective bulb.
5. Push holder back in and turn towards the right.
6. Insert lamp housing first at the outside of the car and then slide in the guide towards the car centre.
7. Tighten fastening screws.
8. Check operation of lights.



Changing bulb for side direction indicator light

1. Remove cap in the wheel housing liner with the screwdriver.
2. Insert the screwdriver into the opening of the wheel housing, parallel to the indicator light (facing forwards).
By pressing with the screwdriver, disengage the securing spring of the direction indicator housing.

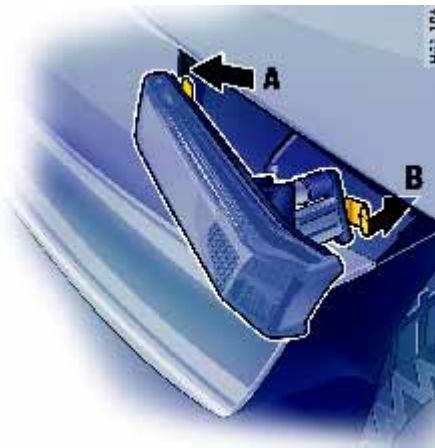

3. Remove indicator light and undo bulb holder (bayonet lock).
4. Remove the bulb from the holder and replace it. Insert holder.
Check operation of the light.
5. Insert the direction indicator's retaining lugs **A** into the side section at the front.
Push in direction indicator until the securing spring **B** is felt to engage.
6. Press cap into the wheel housing liner.

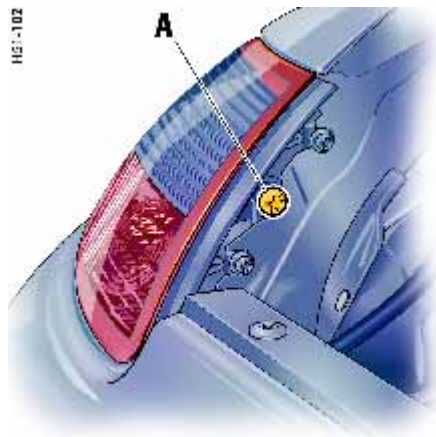

Tail Light

Changing bulb

1. Open the engine compartment lid.
2. Completely unscrew fastening screw **A**.
3. Pull tail light out towards the back.

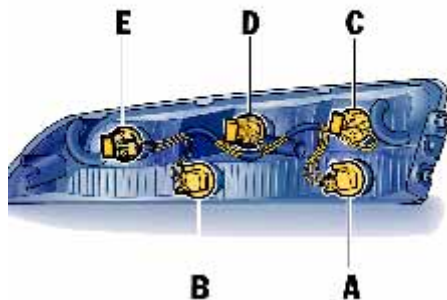

- A** - Reversing light
B - Direction indicator
C - Tail light/brake light
D - Tail light/reflector
E - Rear fog light/tail light

4. Turn the bulb holder in the tail light housing counter-clockwise and pull it out.
5. Turn the defective bulb counter-clockwise (bayonet lock) and replace it.
6. Insert the bulb holder and turn it clockwise.



7. Insert tail light into the side section. Ensure that the retaining lug has been inserted into the side section mounting guide properly.
8. Tighten fastening screw **A** on the tail light.
9. Check operation of the light.



14-0314

Additional Brake Lights

The light-emitting diodes of the additional brake lights cannot be replaced individually.

Have the defective brake light replaced in a qualified specialist workshop.

We recommend a Porsche partner for this work as they have trained workshop personnel and the necessary parts and tools.

Number Plate Light

Changing bulb

1. Undo both screws and take off the light lens.
2. Remove defective bulb from between the contact springs and replace.
3. Reassemble in reverse order.
Check operation of the light.

Changing Headlights from Left to Right-Hand Traffic

If you travel to a country where traffic uses the other side of the road, the headlights must be repositioned when you cross the border. The dipped beam then lights symmetrically and drivers of oncoming vehicles are not dazzled.

On the return journey, do not forget to return the headlights to the "O" position.

Repositioning headlights

1. Remove headlight and open housing lid. Please observe the chapter "REMOVING HEADLIGHTS" on page 221.
2. Set lever to position "T".
3. Close the cover of the headlight housing and install headlight.
4. Reposition the other headlight.

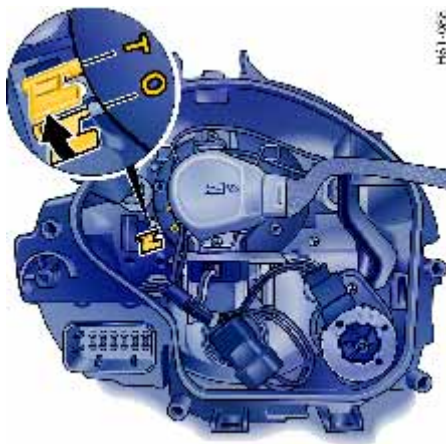

Headlight Adjustment

The adjustment of the headlights should only be done in a specialist workshop with suitable adjustment equipment.

The adjustment is made with the vehicle ready to drive and the fuel tank completely filled.

- ▷ Check tyre pressure and adjust if necessary. Please observe the chapter "TECHNICAL DATA" on page 236.
- ▷ Load the driver's seat with a person or a 75 kg weight. After loading the vehicle, roll it a few metres so that the suspension can settle.



Adjustment screws

1. Unscrew the plastic nut **A** and detach side carpeting in the luggage compartment.

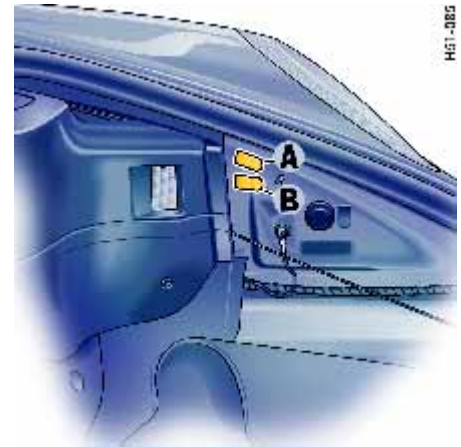

A•B - Lateral adjustment

B - Height adjustment

1. Open up the cover to the relevant adjustment screw.
2. Turn the hexagon socket screw to the right or left.
This changes the headlight adjustment accordingly.

Towing and Tow-Starting



Warning!

Risk of accident. No servo assistance is available on the towed vehicle when its engine is not running. Greater force is therefore necessary when braking and steering. The ABS and PSM do not operate if this is the case.

- ▷ Exercise great care when on tow.
- ▷ Switch on the ignition so that the brake lights and direction indicator lights operate and the steering lock cannot engage.
- ▷ Always keep the towing rope taut when towing. Avoid jerky, sudden loads.
- ▷ Always observe the laws governing towing and tow-starting.



Caution!

Risk of damage when towing due to small ground clearance.

- ▷ When towing and when recovering with a towing vehicle, pay attention to the small ground clearance.
-

Tow-starting

If the battery is defective or completely discharged, the engine can be started only by changing the battery or by using jump leads.

- ▷ Please observe the chapter “JUMP LEAD STARTING” on page 218.

Cars fitted with a catalytic converter may only be tow-started when the engine is cold. If the engine is warm, unburned fuel could damage the catalytic converter.

Vehicles with Tiptronic

The vehicle cannot be tow-started, nor should this be attempted due to the risk of serious transmission damage.

Towing

When being towed, the vehicle must have all four wheels on the ground or it must be moved on a car transporter or a trailer.

Any raising of an axle, irrespective of whether at the front or rear, is only permissible if the drive shaft (cardan shaft) has been removed beforehand. The ignition must be off.

On **vehicles equipped with Tiptronic**, the transmission will not be supplied with sufficient lubrication when the engine is at a standstill. The following points must also be observed to avoid damage to the transmission:

- ▷ Put selector lever in position **N**.
- ▷ Do not exceed the maximum speed of **50 km/h (30 mph)**. Maximum towing distance **50 km (30 miles)**.
If a significant towing distance is involved, then the vehicle must be raised at the rear axle and the drive shaft (cardan shaft) removed.



Fitting towing lug

The towing lug **A** is stored in the tool box in the luggage compartment.

1. Press the lower edge of the appropriate plastic cover into the bumper until the cover disengages.
2. Pull cover out of the bumper and let it hang by its securing thread.
3. Completely screw in the towing lug.



Removing the towing lug

1. Unscrew the towing lug **A**.
2. Insert plastic cover at the lower edge of the opening.
3. Fold the cover up and press on its upper edge to engage it in the bumper.

Vehicle Identification, Technical Data

Vehicle Identification Data	234
Technical Data	236
Diagrams	245

Vehicle Identification Data

- ▷ When ordering spare parts or making inquiries, please always quote the vehicle identification number.

Vehicle data bank

The vehicle data bank is attached to the inside of the “Guarantee and Maintenance” booklet. It contains all important data about your vehicle.

Note

The data bank cannot be re-ordered if it is lost or damaged.

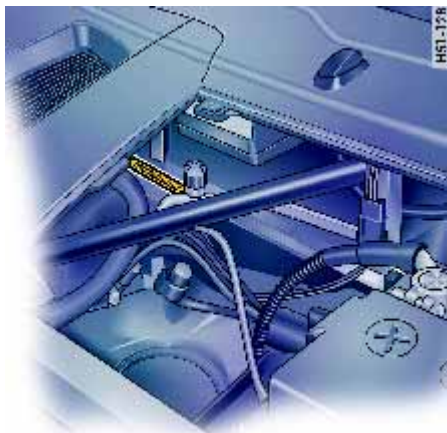

Vehicle identification number

The vehicle identification number is in the luggage compartment under the battery cover and at the bottom left behind the windscreen.

Removing the battery cover

- ▷ Please observe the chapter “BATTERY” on page 214.



Identification plate

The identification plate is fitted to the right-hand door aperture.



Tyre pressure plate

The tyre pressure plate is attached to the left-hand door aperture.



Engine number

The engine number is stamped on the underside of the crankcase.

Technical Data

Engine data

Engine type	M 97/70
Type	Horizontally opposed-cylinder engine, liquid cooled
Number of cylinders	6
Bore	100 mm
Stroke	76.4 mm
Displacement	3600 cm ³
Engine output as per EU at crankshaft speed	353 kW (480 bhp) 6000 rpm
Torque as per EU at crankshaft speed	620 Nm (459 ftlb.) (overboost 680 Nm (503 ftlb.)) 1950 - 5000 rpm (overboost 2100 - 4000 rpm)
Engine oil consumption	up to 1.5 l/1000 km
Maximum rpm	6750 rpm (6th gear 6800 rpm)

Fuel consumption and emission

determined according to 80/1268/EEC as amended

	Engine type	Urban (l/100 km)	Extra-urban Urban (l/100 km)	Total (l/100 km)	Total CO₂ (g/km)
Manual transmission, Coupé	M 97/70	18.8	9.5	12.8	307
Tiptronic S, Coupé	M 97/70	19.8	9.6	13.6	326
Manual transmission, Cabriolet	M 97/70	19.2	9.5	12.9	309
Tiptronic S, Cabriolet	M 97/70	20.2	9.6	13.7	328

Transmission

Transmission ratio		Manual transmission	Tiptronic S
1st gear		3.82	3.59
2nd gear		2.14	2.19
3rd gear		1.48	1.41
4th gear		1.18	1.00
5th gear		0.97	0.83
6th gear		0.79	
Reverse	1st gear	2.67	3.16
	2nd gear		1.93
Final drive ratio		3.44	3.06

Tyres, rims, tracks

		Tyres	Wheel	Rim offset	Track
Summer tyres	front	235/35 ZR 19 (87Y)	8.5J x 19 H2	56 mm	1490 mm
	rear	305/30 ZR 19 (102Y) XL	11J x 19 H2	51 mm	1548 mm
Winter tyres	front	235/40 R 18 91V M+S	8J x 18 H2	57 mm	1488 mm
	rear	295/35 R 18 99V M+S ¹⁾	11J x 18 H2	51 mm	1548 mm
or	front	235/35 R 19 87V M+S	8.5J x 19 H2	56 mm	1490 mm
	rear	295/30 R 19 100V XL M+S ¹⁾	11J x 19 H2	51 mm	1548 mm

The load capacity coefficient (e.g. "91") and maximum speed code letter (e.g. "Y") for permitted top speed are minimum requirements.

When fitting new tyres or changing tyres: Please observe the chapter "TYRES AND WHEELS" on page 199.

Tyre and rim sizes

Approval for tyre and rim sizes is granted on the basis of extensive testing.

Your Porsche partner will be pleased to advise you about the current approval status.

If you refit your vehicle with tyres and/or wheels not authorised by Porsche, this may have a dangerous effect on driving stability.

Snow chains

Snow chain clearance can only be guaranteed with the tyres marked ¹⁾.

Can only be mounted on the rear wheels; maximum permissible speed is 50 km/h (30 mph).

Only use Porsche-approved fine-link cross-type or edge chains.

Tyre pressures for cold tyres

Summer and winter tyres

18 inch and 19 inch wheels, partially loaded (up to 2 persons without luggage)	front	2.3 bar (33 psi)
	rear	2.7 bar (39 psi)
18 inch and 19 inch wheels, fully loaded (2 or more persons with luggage)	front	2.5 bar (36 psi)
	rear	3.0 bar (44 psi)

These tyre inflation pressures only apply to the makes and types of tyres approved by Porsche.

- ▷ Please observe the chapter “TYRES AND WHEELS” on page 199.
- ▷ Please observe the chapter “TPM TYRE PRESSURE MONITORING” on page 93.

Capacities

Use only fluids and fuels authorised by Porsche. Your Porsche partner will be pleased to advise you.

Engine	Oil change quantity without oil filter approx. 7.8 litres Oil change quantity with oil filter approx. 8.0 litres Please observe the chapter "ENGINE OILS" on page 178.
Coolant	Manual transmission approx. 25 litres, Tiptronic approx. 27 litres
Manual transmission and differential	approx. 3.8 litres
Tiptronic S	approx. 9 litres ATF
Tiptronic S differential	approx. 1.2 litres
Fuel tank refill capacity	Left-hand drive vehicles: approx. 67 litres, including approx. 12 litres reserve Right-hand drive vehicles: approx. 66 litres, including approx. 12 litres reserve
Fuel quality	The engine has been designed for optimum performance and fuel consumption using unleaded premium fuel with RON 98/MON 88 . If unleaded premium fuels with octane numbers of at least RON 95/MON 85 are used, the engine's knock control automatically adapts the ignition timing.
Power steering	approx. 2.14 litres hydraulic fluid Pentosin CHF 11 S or Pentosin CHF 202
Brake fluid	approx. 0.45 litre; use only genuine Porsche brake fluid or brake fluid of similar quality.
Windscreen washer system	approx. 6 litres with headlight washer

Weights

Coupé

Empty weight (depending on equipment)
per DIN 70020
per 70/156/EEC ¹⁾
Maximum gross weight
Maximum axle load, front ²⁾
Maximum axle load, rear ²⁾
Maximum load, Roof Transport System ³⁾

Manual transmission

1585 kg
1660 kg
1950 kg
825 kg
1250 kg
75 kg

Tiptronic S

1620 kg
1695 kg
1980 kg
825 kg
1250 kg
75 kg

Cabriolet

Empty weight (depending on equipment)
per DIN 70020
per 70/156/EEC ¹⁾
Maximum gross weight
Maximum axle load, front ²⁾
Maximum axle load, rear ²⁾

Manual transmission

1655 kg
1730 kg
2000 kg
825 kg
1250 kg

Tiptronic S

1690 kg
1765 kg
2035 kg
825 kg
1250 kg

¹⁾ Empty weight includes 75 kg driver and baggage share.

²⁾ The maximum gross weight must not be exceeded. Note: If additional accessories are installed, the available load capacity will be correspondingly less.

³⁾ Only use Roof Transport Systems from the Porsche Tequipment product range for your car or Roof Transport Systems which have been tested and approved by Porsche.

Driving performance

Coupé	Manual transmission	Tiptronic S
Maximum speed	310 km/h (193 mph)	310 km/h (193 mph)
Acceleration 0 - 100 km/h (62 mph)	3.9 seconds	3.7 seconds

Cabriolet	Manual transmission	Tiptronic S
Maximum speed	310 km/h (193 mph)	310 km/h (193 mph)
Acceleration 0 - 100 km/h (62 mph)	4.0 seconds	3.8 seconds

Driving performance at DIN empty weight and half load, without performance-inhibiting additional equipment (e.g. special tyres)

Dimensions

Length	4450 mm
Width without door mirrors	1852 mm
Height	1300 mm
Wheelbase	2350 mm
Ground clearance at maximum gross weight	101 mm
Turning circle	10.9 m

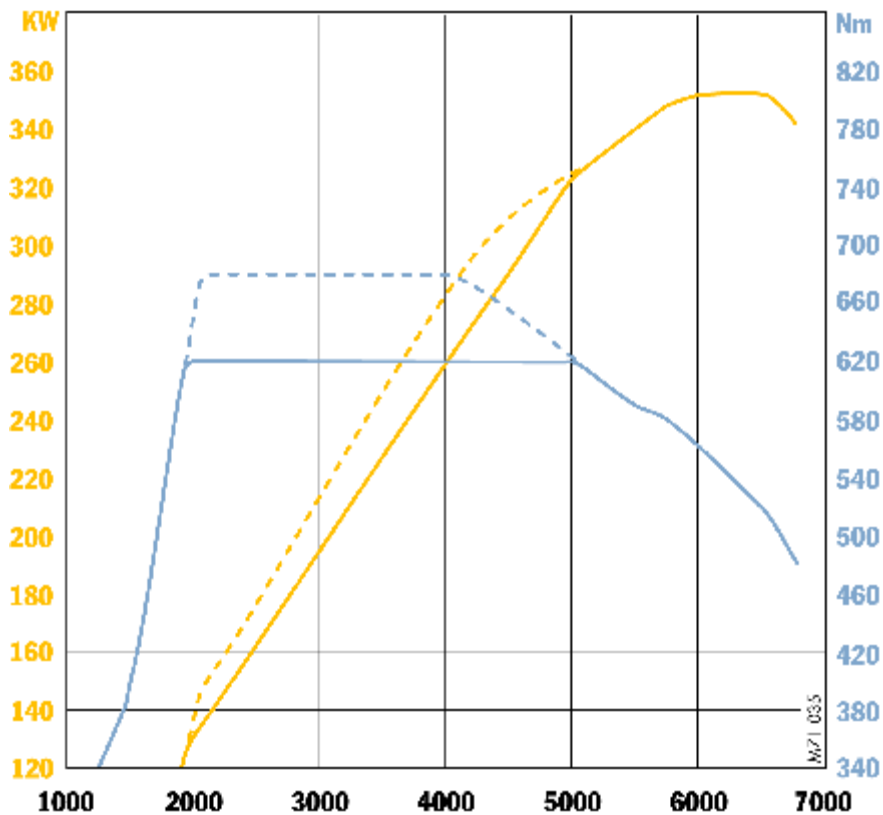

Acceleration diagram for manual transmission,

Values have been determined for DIN empty weight and with a 50 % load capacity without additional equipment.

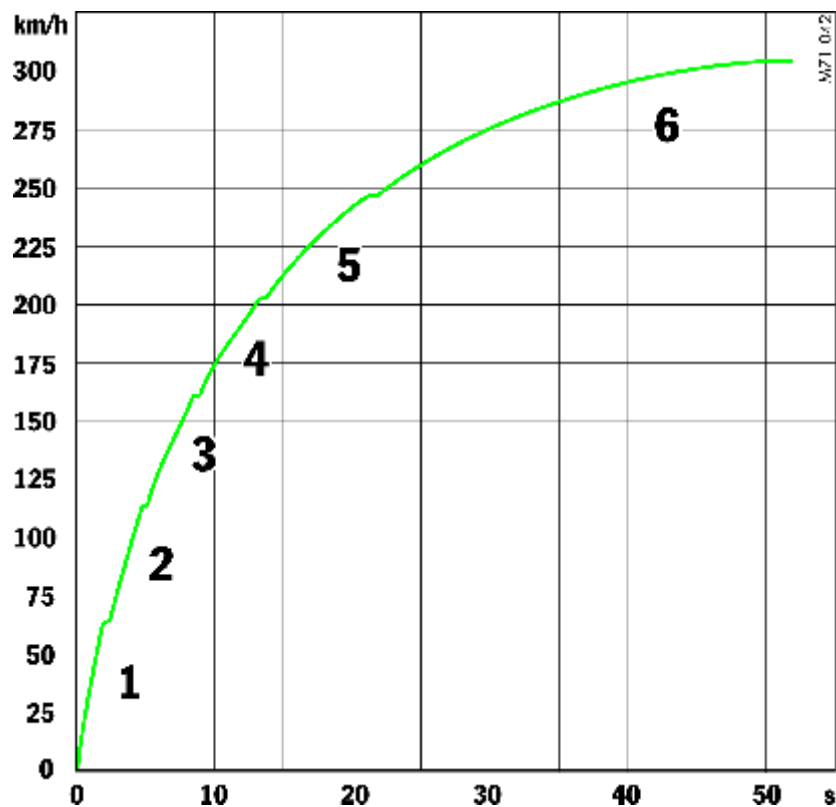

Index

A

ABS (anti-lock brake system).....	44
Warning light	45
Air cleaner.....	187
Air distribution	122
Airbag systems.....	38
Switching off passenger airbag	36
Warning light	39, 40
Air-conditioning compressor	122, 124
Alarm system	17, 211
Alcantara	196
All-wheel drive.....	56
Antenna	136
Anti-lock brake system (ABS)	44
Ashtray	129
Auto-button air conditioning	122
Automatic air-conditioning system	122
Automatic anti-dazzle function.....	21
Automatic door locking	15
Automatic relocking	13
Automatic window lowering.....	19
Average consumption.....	77, 105
Average speed	77, 105

B

Backrest	
Adjustment	23
Release	23
Battery.....	214
Battery charge indicator	74
Charge state	215

Putting vehicle into operation	216
Remote control.....	218
Warning light.....	74
Battery charge indicator	74
Warning light.....	74
Before Driving Off	8
Belts	31, 196
Belt tensioner	31
Height adjustment	32
Warning light.....	31
Blower adjustment	123
Brake light.....	228
Brakes	41, 42, 44, 180
Brake circuit division warning light.....	180
Brake pad warning light	43
Fluid.....	180, 241
Fluid warning light	181
Pads	8, 43
Test stand	43, 50, 56
Warning light.....	75
Bulbs	
Chart	220
Replacing	220

C

Cabriolet	154
Capacities, overview	241
Car care.....	190
Car telephone.....	135
Car wash.....	191
Care	190

Carpet	196
Catalytic converter	182
Central locking.....	13, 211
Central vents	125
Central warning light	75
Check Engine warning light	75
Checking hydraulic fluid	186
Child Restraint System	33
Switching off passenger airbag	36
CHRONO Stopwatch.....	86
Cigarette lighter.....	129
Circulating-air button	123
Clock	73, 104
Clothes hook	130
Clutch	142
Combination filter.....	187
Comfort seat	23
Compact disc	
holder	131
Compressor	134
Convertible Top	154
Care.....	191
Coolant	70, 177, 241
Temperature gauge, warning light	70
Cooling system.....	70
Cruise control.....	66, 119
Indicator light.....	66
Cupholder	127

D

Data bank	234
Defrosting windows.....	123
Diagrams	245
Dimensions	244
Dipped beam.....	114
Direction indicator	69, 115
Indicator light.....	69
Stalk	115
Direction indicator light, side	225
Direction indicator, front.....	225
Direction indicator, rear.....	227
Door mirrors	20, 21, 55
Automatic anti-dazzle function.....	21
Heating	22, 126
Door oddments tray.....	16
Doors	16
Handles.....	16
Locks	16, 192
Windows	16, 18, 154
Drink can holder	127
Driver's Manual	1
Driving	
Winter	148
Driving performance	243
DVD navigation	134

E

Electrical system	210
Emergency operation	
Central locking.....	14
Convertible Top	157
Ignition key.....	61
Sliding roof.....	152

Emergency unlocking

Filler flap	184
Lids	213

Engine

Checking the oil level.....	101
Data.....	236
Number	235
Oil consumption	8, 236
Oil level gauge	101
Oil pressure gauge.....	74
Oil temperature.....	66
Oils	178, 241
Starting	62
Stopping	62
Topping up oil.....	179

Engine compartment

Blower	63, 70
Cleaning, preserving.....	193
Lid	132

Exhaust gas

Cleaning	75, 182
Monitoring	75
Monitoring warning light.....	75

F

Filling pressure, tyres	240
Fire extinguisher	137
First aid kit	134, 198
Floor mats.....	196
Fluids and fuels.....	241
Fog lights.....	114
Footbrake	42, 44
Four-Wheel Drive	56
Front lid	132

Front windscreen wipers.....	116
Fuel	183, 241
Consumption.....	237
Level gauge, warning light.....	72
Tank.....	183
Fuel Can	184
Function keys.....	29
Fuses	212

G

Garage door opener	138
Assigning buttons.....	139
Erasing button assignments	140
Glove compartment.....	131
Gong.....	79, 114
Ground clearance.....	3, 244

H

Handbrake.....	41
Warning light.....	41
Hand-held transmitter	138, 139
Hands-free microphone.....	135
Hardtop.....	168
Hazard warning lights	14, 17, 121
Headlight Beam Adjustment	115
Headlights	195, 221, 230
Adjustment	229
Washer system	116, 185, 241
Heated rear window	22, 126
Heating	122
High beam	
Indicator light.....	69
Stalk	114

High-pressure cleaning units	190, 193
Home mode	114
HomeLink	138
Horn	9, 17
Horn button	9

I

Identification plate	234
Ignition lock	60, 145
Emergency operation	61
Immobiliser	10
Indicator lights	64
Instrument	
Illumination	66, 114
Instrument panel	64, 106
Interior lights	57
Interior mirror	21
Automatic anti-dazzle function	21
Intermittent operation switch	116
ISOFIX system	37

J

Jack	207
Jump Lead Starting	218, 219

K

Keys	10
------------	----

L

Laying up the vehicle	196
Leather	195
Lids	132
Emergency unlocking	213

Light

Horn	69
Stalk	114
Light alloy wheels	194
Inscription	203
Light sensor for instrument illumination	66
Load switch-off	211
Locking conditions	13
Luggage compartment	132
Emergency unlocking	213
Luggage compartment lid/ engine compartment lid warning light	132
Luggage rack	174, 242

M

Maintenance	176
Make-up mirror	30
Maximum engine speeds	8, 236
Maximum permitted engine speeds ..	8, 142, 236
Minor repairs	198
Mirrors	20, 55
Automatic anti-dazzle function	21
Parking aid	55
Multi-functional steering wheel Function keys	29

N

Navigation	136
Notes on	
Car care	190
Maintenance	176
Minor repairs	198
Number plate light	114, 228

O

Odometer	67
Off delay	114
Oil	66, 178, 241
Checking level	101
Consumption	8, 236
Level indicator	101
Pressure indicator	74
Temperature	66
Topping up	179
On-board computer	76
Basic settings	103
Language versions	103
On-board literature	1
Orientation light	57
Outside temperature indicator	73

P

Paint	
Care	192
Data	235
ParkAssist	54, 55
Parking	148
Parking Aids	54, 55
Parking brake	41
Parking light	115
Particle filter	187
Passenger compartment monitoring system	17
Plastic parts, care of	195
Platform lift	207
Porsche Active Suspension Management (PASM)	51

Porsche Ceramic Composite Brake (PCCB).....	2
Porsche Communication Management (PCM)	136
Porsche Stability Management (PSM).....	48
Information light.....	50
Power measurement.....	176
Power Steering.....	186, 241
Power windows	18

R

Radiator fans.....	63, 70, 177
Radio.....	136
Rain sensor.....	116
Range on remaining fuel.....	77, 105
Reading light	57
Rear lid.....	132
Rear seat backrests.....	28
Rear spoiler.....	52
Rear window wiper.....	117
Reduced driving programme, Tiptronic	148
Relays.....	210
Remote control.....	11, 12
Synchronisation	12
Replacement keys	10
Rims.....	191, 194, 239
Roll-Over Protection	40
Roof Transport System	174, 242
Running in.....	8

S

Sealant	205
Seals, care of.....	195
Seat.....	23
Heating	27
Memory.....	25
Position.....	23
Seat Belts	31, 196
Height adjustment.....	32
Warning light.....	31
Selector lever position indicator	71, 144
Service indicator.....	112
Shifting Gears.....	142
Side direction indicator lights.....	226
Side light.....	114
Side vents	125
Sliding/lifting roof	150
Snow chains.....	202, 239
Sockets	210
Spare	
Fuel can	184
Keys	10
Speed control.....	66, 119
Speed Limit.....	79
Speedometer	68
With analogue display.....	68
With digital display	68
Spoiler.....	52
Sport Chrono package Plus	
CHRONO Stopwatch.....	86
Sport Mode	46
Sport Mode	46, 51
Sports seat	23
Spray jets.....	116

Stability management system (PSM)	48
Stainless steel tailpipes	194
Starting.....	60
Starting and stopping	62
Starting the engine.....	62
Steering wheel	
Adjustment	28
Buttons	29
Lock.....	60
Rocker switches.....	143
Stopwatch.....	86
Storage options	130
Sun visors	30
Switching off passenger airbag	33
Switching passenger airbag on and off	36

T

Tachometer.....	69
Tank	183
Technical	
Data.....	236
Modifications	2
Telephone.....	135
Temperature.....	66
Temperature setting.....	122
Test stand, measurements	43, 50, 56, 176
Theft Protection	16
Tightening torque for wheel bolts	209
Tips for	
Running In.....	8
Tiptronic.....	71, 143
Display	71
Tool kit.....	134, 198
Tools	134

Towing.....	186, 231
Towing lug.....	134
Tow-starting.....	231
Track.....	239
Transmission.....	142, 238
Trip counter.....	67
Tyre filling pressure.....	240
Tyre pressure	
Compressor.....	134
Plate.....	235
Tyre Pressure Monitoring (TPM).....	93
Tyre sealant.....	205
Tyres.....	199, 239
Dimensions.....	239
Filling pressure.....	97, 240
Flat.....	205
Inscription.....	203
Sealant.....	134, 205
Tread.....	200
Tyres and tyre care.....	199

U

Undersealing.....	182, 194
-------------------	----------

V

Vehicle	
Care.....	190
Data.....	234
Identification number.....	234
Laying up the vehicle.....	196, 216
Putting into operation.....	216
Raising.....	207

Ventilation.....	122
Vents.....	122
Viscosity.....	178

W

Warning lights.....	64
Warning messages.....	106
Warning triangle.....	134, 198
Washer Fluid.....	241
Warning message.....	185
Washer system, windscreen wipers.....	116
Washing.....	190
Weights.....	242
Welcome Home function.....	114
Wheel	
Bolts.....	204
Changing.....	205, 208
Security wheel bolts.....	10, 134, 204
Wheels.....	191, 194, 199, 239
Inscription.....	203
Windows.....	18, 193
Car wash.....	116, 185, 241
Concentrated window cleaner.....	185
Spray jets.....	116, 185
Windscreen wiper/washer stalk.....	116
Windscreen wipers.....	116
front.....	116
Rear.....	117
Replacing.....	188
Windstop.....	164

Winter operation

Battery.....	215
Coolant.....	177
Engine oil.....	178
Jump Lead Starting.....	218, 219
Locks.....	192
Seals.....	195
Snow chains.....	202, 239
Tyres.....	202, 239
Washer Fluid.....	185
Wipe interval.....	116
Wiper blades.....	194
Changing.....	188

